

# STREAMING VIDEO SWITCHER V-160HD



# Contents

<b>Panel Descriptions</b> .....	4	<b>Compositing Video with Downstream Keyer (DSK)</b> .....	30
◇ Top Panel .....	4	About DSK Mode .....	30
◇ Front Panel .....	6	Compositing a Caption or Image (Luminance Key) .....	31
◇ Rear Panel .....	7	Compositing a Subject and Background (Chroma Key) .....	33
◇ Connecting Bluetooth® Devices .....	8	Compositing a Still Image with Alpha Channel .....	35
◇ Connecting a Footswitch .....	9	Using an External Key .....	36
<b>Basic Operations</b> .....	10	<b>Audio Operations</b> .....	37
◇ Turning the Power On/Off .....	10	◇ Adjusting the Input Gain (Sensitivity) .....	37
◇ Operating the Menu .....	10	◇ Adjusting the Volume Balance .....	38
◇ Switching the Monitor View .....	11	◇ Applying Effects to Input Audio .....	39
Suppressing Echo in a Web Conference System (Echo Canceller) ..		Reducing Acoustic Feedback (Anti-Feedback) .....	40
<b>Video Input/Output Settings</b> .....	12	Changing the Character of a Voice (Voice Changer) .....	41
◇ Setting the Video Input/Output Format .....	12	Correcting a Time Difference Between Video and Audio (Delay) ...	41
Setting the System Format .....	12	◇ Applying Effects to Output Audio .....	42
Setting the Input Format for the HDMI IN 5–8 Connectors .....	12	◇ Interlinking Audio Output to Video Switching	
◇ Assigning Video Sources .....	13	(Audio Follow) .....	43
◇ Adjusting Output Video .....	13	◇ Controlling the Volume Automatically (Auto Mixing) .....	43
◇ Adjusting Input Video .....	14	◇ Checking a Specific Audio Input (Solo) .....	44
◇ Assigning Video Buses to Output Connectors .....	14	◇ Silencing Only Specific Audio (Mute) .....	44
◇ Selecting the Video Sent to the AUX Bus .....	15	◇ Outputting AUX-bus Audio .....	45
◇ Inputting Copy-Protected (HDCP) Video .....	15	◇ Adding Input Audio to an HDMI or SDI Video for Output ...	46
◇ Specifying a Reference Clock .....	16	<b>Live Streaming</b> .....	47
<b>Video Operations</b> .....	17	◇ Outputting Video/Audio to a Computer for Streaming .....	47
◇ Switching the Video .....	17	Outputting Video and Audio to the Computer .....	47
Setting the Operation Mode .....	17	Using the Loopback Function .....	47
Switching in the PGM/PST Mode .....	17	<b>Other Functions</b> .....	48
Switching in the A/B Mode .....	18	◇ Saving/Recalling Settings (Preset Memory) .....	48
Changing the Mix/Wipe Pattern .....	19	Saving to a Preset Memory .....	48
Changing the Functions of the [CUT] and [AUTO] Buttons .....	19	Recalling a Preset Memory .....	48
◇ Switching the Video Automatically (Auto Switching) .....	20	Initializing a Preset Memory .....	49
About the Operation Mode .....	20	Renaming a Preset Memory .....	49
Turning the Auto Switching Function On/Off .....	20	◇ Recording Multiple Operations to Automatically Execute	
Setting the Operation Mode .....	20	(Macros) .....	50
◇ Loading a Still Image .....	22	Recording a Macro .....	50
Loading a Still Image from a USB Flash Drive .....	22	Executing a Macro .....	52
Capturing a Still Image from Input/Output Video .....	23	Copying Macro Settings .....	53
Deleting a Still Image .....	23	Swapping the Macro Settings .....	53
◇ Saving a Still Image to a USB Flash Drive .....	24	Initializing a Macro .....	54
◇ Outputting a Loaded Still Image .....	25	Renaming a Macro .....	54
◇ Freezing the Input Video (Freeze) .....	25	Saving/Loading the Macro Settings .....	55
◇ Fading-In/Out the Final Output Video .....	26	◇ Combining Preset Memories and Macros for Operations	
<b>Video Composition Operations</b> .....	27	(Sequencer) .....	57
◇ Compositing Video with Split .....	27	Recording to the Sequencer .....	57
Configuring the Screen Layout .....	27	Running the Sequencer .....	59
Compositing Using SPLIT .....	27	Making the Sequencer Run Automatically (Auto Sequence) .....	60
◇ Compositing Video with Picture-in-Picture (PinP) .....	28	Saving/Loading the Sequencer Settings .....	61
Making Detailed Settings for the Inset Screen .....	29	Initializing the Sequencer .....	62
Key Compositing the Inset Screen .....	29	◇ Backing Up and Restoring the Unit's Settings .....	63
		Backing Up .....	63
		Restoring .....	64

◇ Formatting a USB Flash Drive .....	64
◇ Assigning Functions to the USER Buttons .....	65
◇ Controlling an External Recorder's Video Record Start/Stop from the V-160HD .....	65
◇ Remotely Controlling a PTZ Camera .....	66
Network Settings on the Camera .....	66
Registering Camera Settings in a Preset .....	66
Recalling a Preset .....	67
◇ Using a Footswitch .....	68
◇ Using an Expression Pedal .....	69
◇ Control Using the TALLY/GPIO Connector .....	70
Specification of the TALLY/GPIO Connector .....	70
Inputting a Control Signal .....	70
Outputting a Tally Signal .....	71
Outputting a Control Signal .....	71
◇ Using Smart Tally .....	72
◇ Preventing Unintended Operation (Panel Lock) .....	73
◇ Returning to the Factory Settings (Factory Reset) .....	73
◇ Remotely Controlling the V-160HD .....	74
<b>Menu List .....</b>	<b>75</b>
1: VIDEO ASSIGN .....	75
2: VIDEO INPUT .....	76
3: VIDEO OUTPUT .....	77
4: TRANSITION TIME .....	77
5: MIX/WIPE .....	78
6: SPLIT .....	78
7: PinP & KEY .....	79
8: DSK .....	81
9: AUDIO INPUT .....	82
10: AUDIO OUTPUT .....	88
11: AUDIO FOLLOW .....	90
12: AUDIO AUTO MIXING .....	90
13: PRESET MEMORY .....	91
14: MACRO .....	92
15: SEQUENCER .....	93
16: STILL IMAGE .....	93
17: FREEZE .....	94
18: AUTO SWITCHING .....	94
19: CTL/EXP .....	95
20: RS-232/TALLY/GPO/GPI .....	97
21: LAN CONTROL .....	98
22: CAMERA CONTROL .....	99
23: USB MEMORY .....	100
24: SYSTEM .....	100
◇ List of Shortcut Keys .....	104

<b>Appendix .....</b>	<b>105</b>
◇ About Rack Mounting .....	105
◇ Main Specifications .....	106
◇ Dimensions .....	109
◇ Video Block Diagram .....	110
◇ Audio Block Diagram .....	111

- The **Bluetooth®** word mark and logos are registered trademarks owned by Bluetooth SIG, Inc. and any use of such marks by Roland is under license.
- QR Code is a registered trademark of DENSO WAVE INCORPORATED in Japan and in other countries.
- Roland is an either registered trademark or trademark of Roland Corporation in the United States and/or other countries.
- Company names and product names appearing in this document are registered trademarks or trademarks of their respective owners.

# Panel Descriptions

## Top Panel

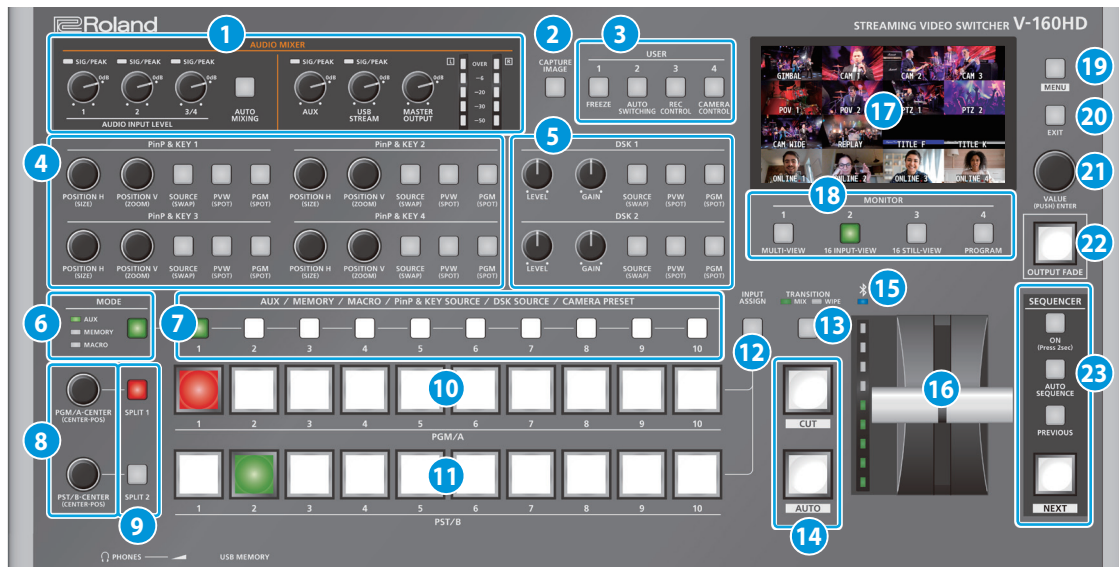

### 1 AUDIO MIXER

#### SIG/PEAK indicators (1, 2, 3/4)

Shows the volume level for the AUDIO IN 1, 2, or 3/4.

Indicator	Status
Red	Volume is excessive (0 dB or higher)
Yellow	Volume is appropriate (-20 – -1 dB).
Green	Volume is insufficient (-50 – -21 dB).

#### AUDIO INPUT LEVEL [1] [2] [3/4] knobs

Adjust the volume of the AUDIO IN 1, 2, or 3/4.

#### [AUTO MIXING] button

Turns the auto-mixing function (used to automatically control the volume) on/off.

#### SIG/PEAK indicators (AUX, USB STREAM)

Shows the volume level for the AUX bus and USB output.

#### [AUX] knob

Adjusts the volume of the AUX bus output.

#### [USB STREAM] knob

Adjusts the volume of the USB output.

#### [MASTER OUTPUT] knob

Adjusts the overall volume.

#### Level meter

Indicates the volume level of the overall output.

### 2 [CAPTURE IMAGE] button

Turns the still image capture mode on/off.

### 3 USER [1]–[4] buttons

These buttons execute pre-assigned functions.

With the factory settings, the following functions are assigned.

Button	Explanation
USER [1]	<b>FREEZE</b> Turns the freeze function (freeze the input video) on/off.
USER [2]	<b>AUTO SWITCHING</b> Turns the auto switching function (used to automatically switch between videos) on/off.
USER [3]	<b>REC CONTROL</b> Controls the recorder's video record start/stop if a recorder that supports REC control functionality is connected.
USER [4]	<b>CAMERA CONTROL</b> Turns the camera control function on/off. When this is on (lit), the 7 CAMERA PRESET [1]–[10] buttons are used to recall the presets.

### 4 PinP & KEY 1–4

This uses PinP and KEY 1–4 layers to composite video using PinP, or picture-in-picture (p. 28).

#### [POSITION H] knob

Adjusts the horizontal position of the inset screen.

By turning the knob while pressing it, you can adjust the size of the inset screen.

#### [POSITION V] knob

Adjusts the vertical position of the inset screen.

By turning the knob while pressing it, you can adjust the zoom of the video shown in the inset screen.

#### [SOURCE] button

When this is on (lit), you can select the video source for the inset screens using the 7 PinP & KEY SOURCE [1]–[10] buttons.

#### [PVW] button

Turns the inset screen preview output on/off.

#### [PGM] button

Turns PinP composition on/off.

**5 DSK 1, 2**

This uses DSK layer 1 or 2 to composite video using a downstream keyer (p. 30).

**[LEVEL] knob**

Adjusts the degree of extraction (transparency) for the key.

**[GAIN] knob**

Adjusts the degree of edge blur (semi-transmissive region) for the key.

**[SOURCE] button**

When this is on (lit), you can select the DSK video source using the **7** PinP & KEY SOURCE [1]–[10] buttons.

**[PVW] button**

Turns the preview output of the DSK compositing result on/off.

**[PGM] button**

This switches DSK composition on or off.

**6 [MODE] button**

**7** Switches the functioning of the AUX / MEMORY / MACRO [1]–[10] buttons. An indicator located at the left of the [MODE] button is lit to indicate the current function.

**7 AUX / MEMORY / MACRO / PinP & KEY SOURCE / DSK SOURCE / CAMERA PRESET [1]–[10] buttons**

The functions of these buttons change as shown in the table below.

When button is lit	Functions of buttons [1]–[10]
[MODE]	<b>AUX</b> Select the video that is sent to the AUX bus.
	<b>MEMORY</b> Recalls the preset memory (the video/audio and other data that is saved). Long-press a button to save the current settings in a preset memory.
	<b>MACRO</b> Executes a macro (a series of recorded operations).
PinP & KEY 1–4 [SOURCE]	<b>PinP &amp; KEY SOURCE</b> Select the video source for the inset screen (p. 28).
DSK 1, 2 [SOURCE]	<b>DSK SOURCE</b> Selects the DSK video source (p. 30).
USER [4] (CAMERA CONTROL)	<b>CAMERA PRESET</b> Recalls the registered preset (camera position, focus settings, etc.) from the connected camera.

**8 [PGM/A-CENTER] [PST/B-CENTER] knobs**

Adjust the split compositing settings (p. 27).

Knob	Explanation
[PGM/A-CENTER]	Adjusts the horizontal/vertical position of the video that's shown in the left or upper area. <b>Turn while pressing:</b> Adjusts the position of the boundary.
[PST/B-CENTER]	Adjusts the horizontal/vertical position of the video that's shown in the right or lower area. <b>Turn while pressing:</b> Adjusts the position of the boundary.

**9 [SPLIT 1] [SPLIT 2] buttons**

Turns on/off video compositing using split (p. 27).

**10 PGM/A cross-point [1]–[10] buttons**

Selects the video to input to bus PGM/A. The selected button lights up.

**11 PST/B cross-point [1]–[10] buttons**

Selects the video to input to bus PST/B. The selected button lights up.

**12 [INPUT ASSIGN] button**

Press a cross-point button while holding down the [INPUT ASSIGN] button to change the video source for the buttons you pressed. The video source changes in the following order each time you press the button.

- [INPUT ASSIGN] + PGM/A cross-point buttons

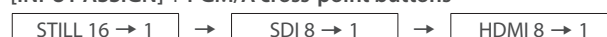

- [INPUT ASSIGN] + PST/B cross-point buttons

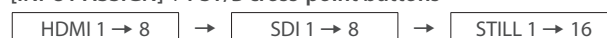

**13 [TRANSITION] button**

Selects the video transition effects (MIX, WIPE). The MIX or WIPE indicator lights to show that it is selected.

**14 [CUT] [AUTO] button**

Automatically switch between the videos being input to bus PGM/A and PST/B, and send them to the final output.

Button	Explanation
[CUT]	The picture switches instantly.
[AUTO]	A transition effect is applied and the video is switched automatically.

**15 (Bluetooth®) indicator**

Shows the Bluetooth connection status.

Lit	Connected	Rapid blinking	Now pairing
Unlit	Bluetooth off	Blinking	Waiting for connection

You can input audio from an audio device that uses Bluetooth, or use dedicated app on your computer or iPad to remotely control the V-160HD.

**16 Video fader**

Manually switch between the videos being input to bus PGM/A and PST/B, and send them to the final output.

**Transition indicator**

The indicators light up to show the video fader position. When the video fader is pushed all the way down, only the topmost or bottommost transition indicator lights.

**17 Monitor**

Shows the input/output video, a loaded still image, or a menu.

\* The same video as that shown on the monitor of this unit is output from the HDMI OUT 3 connector.

**18 MONITOR [1]–[4] buttons**

Switches between the video to monitor. Both the display from the monitor of this unit and the output video from the HDMI OUT 3 connector switch at the same time.

Button	Explanation
MONITOR [1]	<b>MULTI-VIEW</b> The final output video, preview output video and the videos allocated to the cross-point [1]–[8] buttons are shown in sections of the display.
MONITOR [2]	<b>16 INPUT-VIEW</b> The input video from the HDMI IN connectors and the SDI IN connectors are shown as 16 separate sections on the screen.
MONITOR [3]	<b>16 STILL-VIEW</b> Shows the loaded still images in 16 separate sections on the screen.
MONITOR [4]	<b>PROGRAM</b> Shows the final output video.

\* The settings described above are the factory defaults. You can also assign different video to each button.

**19 [MENU] button**

Switches the menu between visible and hidden. The menu appears on the built-in monitor and the display connected to the HDMI OUT 3 connector.

**20 [EXIT] button**

Returns you to the menu one level higher.

**21 [VALUE] knob**

Selects a menu item, or edits the value of a setting. Press this knob to confirm the menu item you selected or the value that you edited.

**22 [OUTPUT FADE] button**

The final output video and audio fade in/out.

Lit	Fade-out completed
Blinking	Now fading-in/out
Unlit	Normal output

**23 SEQUENCER**

Use this to execute operations such as macros or recalling preset memories (sequencer function) in the order that you have specified beforehand.

**[ON] button**

Long-press to turn sequencer function on/off.

**[AUTO SEQUENCE] button**

Turns the auto sequence function on/off.

**[PREVIOUS] button**

Returns to the previous operation.

**[NEXT] button**

Advances to the next operation. The button blinks while the operation is executing.

Front Panel

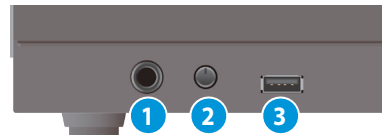

**1 PHONES jack**

Connect headphones.

**2 [PHONES] knob**

Adjusts the volume of the headphones.

**3 USB MEMORY port**

Connect a USB flash drive. Use this to save/load the settings of this unit, and to load/save still images.

\* Never turn off the power or remove the USB flash drive while the USB flash drive is being accessed.

## Rear Panel

- \* To prevent malfunction and equipment failure, always turn down the volume, and turn off all the units before making any connections.
- \* Do not block the cooling-fan intake and exhaust ports on the side panels. If the cooling-fan intake and exhaust ports are blocked, the internal temperatures may rise, causing malfunctions due to excessive heat.

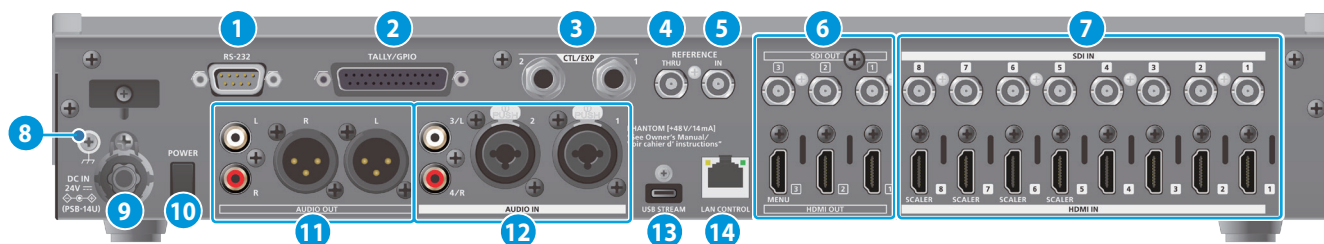

### Pin assignment of AUDIO OUT jacks (XLR)



### Pin assignment of AUDIO IN 1 and 2 jacks (XLR/TRS)



#### 1 RS-232 connector

You can connect this to a computer equipped with an RS-232 connector, and remotely control the V-160HD.

#### 2 TALLY/GPIO connector

Use this to connect to devices that have a tally indicator feature, or to connect to devices that have a control signal input/output function.

#### 3 CTL/EXP 1, 2 jacks

Connect footswitches (sold separately: BOSS FS-6, etc.) or expression pedals (sold separately: EV-5, etc.). This is used when using your foot to control operations such as video switching.

- \* Use only the specified expression pedal (sold separately: EV-5, BOSS FV-500L, or FV-500H). By connecting any other expression pedals, you risk causing malfunction and/or damage to the unit.

#### 4 REFERENCE THRU connector

Sends the synchronization signal that is inputted to the V-160HD to an external device that is connected to this unit.

#### 5 REFERENCE IN connector

Connect an external source device for synchronization in order to input a sync signal.

#### 6 HDMI OUT 1-3 connectors, SDI OUT 1-3 connectors

These connectors output video. Choose the connectors that are appropriate for the connected devices.

For each connector, you can change the video bus that is assigned for output from that connector. With the factory settings, the bus assignments are as follows.

Connector	Bus
SDI/HDMI OUT 1	PROGRAM (final output video)
SDI/HDMI OUT 2	PREVIEW (preview output video)
SDI/HDMI OUT 3	MULTI-VIEW

#### 7 HDMI IN 1-8 connectors, SDI IN 1-8 connectors

These connectors input video. Choose the connectors that are adaptor for the connected devices.

The input format is automatically recognized.

#### 8 Ground terminal

Connect this to an external earth or ground if necessary.

#### 9 DC IN jack

Connect the included AC adaptor to this jack.

- \* Use the cord hook to secure the cord of the AC adaptor as shown in the illustration. If you have trouble running the cord through, loosen the screw a little on the cord hook.

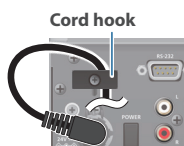

#### 10 [POWER] button

Turns the power on/off.

#### 11 AUDIO OUT jacks (XLR, RCA)

These jacks output audio. Choose the jacks that are appropriate for the connected devices.

For each jack, you can change the audio bus (MASTER OUTPUT, AUX) that is assigned for output from that jack.

#### 12 AUDIO IN 1, 2, 3/L, 4/R jacks

These jacks input audio. Choose the jacks that are appropriate for the connected devices.

#### \* About phantom power

You can supply phantom power (+48 V) from the AUDIO IN 1 and 2 jacks (XLR). Turn on phantom power when you're using a condenser microphone that requires phantom power.

Use the [MENU] button → "AUDIO INPUT" → "AUDIO IN 1" or "AUDIO IN 2" → set "PHANTOM +48V" to "ON."

#### 13 USB STREAM port (USB Type-C®)

- Outputs the audio and video to your computer. This is also used to input audio played on your computer to the V-160HD.
- Use the dedicated app to remotely control the V-160HD from a computer or iPad that is connected.

#### Connecting an iPad

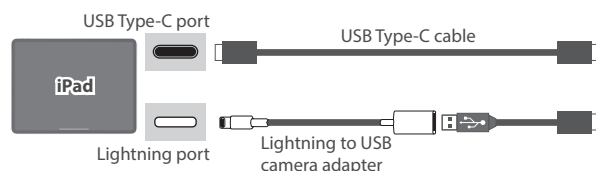

- \* If you are outputting HD video via USB, connect this to a USB 3.0 port of your computer.

- \* If you connect via an extension cable or a USB hub, the computer might not recognize this unit.

#### 14 LAN CONTROL port

- Lets you remotely control the V-160HD by using terminal app, etc.
- Use the dedicated app to remotely control the V-160HD from a computer or iPad that is connected.
- Use the V-160HD to remotely control a camera that is connected.
- Displays a tally on your iOS or Android device (this is the "smart tally" function).

## Connecting Bluetooth® Devices

Use the Bluetooth features of the V-160HD to connect it to your Bluetooth-compatible mobile device. This lets you do the following:

- Input the audio signals from your Bluetooth audio device.
- Use dedicated app “V-160HD RCS” or “V-160HD Remote” to remotely control the V-160HD from a computer or iPad (p. 74).  
\* For more on connecting (pairing) with a dedicated app, see the app’s Owner’s Manual.

### Registering a Bluetooth Audio Device (Pairing)

To connect a Bluetooth device to this unit, you must pair (register) the device with the unit.

Once you pair the device with this unit, there is no need to do it again.

\* To connect a Bluetooth device that’s already paired, refer to “Connecting an Already-Paired Bluetooth Device” on this page.

\* See the Owner’s Manual for the Bluetooth device you want to pair for details on the necessary operations.

1. Place the Bluetooth device nearby the V-160HD.
2. [MENU] button → “SYSTEM” → “Bluetooth” → select “Bluetooth,” and press the [VALUE] knob.



3. Use the [VALUE] knob to select “ON,” and press the [VALUE] knob.

The V-160HD’s Bluetooth function turns on.

4. Use the [VALUE] knob to select “PAIRING,” and press the [VALUE] knob.

A confirmation message appears.



\* If you decide to cancel, press the [EXIT] button.

5. Use the [VALUE] knob to select “YES,” and press the [VALUE] knob.

Pairing begins.



6. Turn on the Bluetooth function of the Bluetooth device.

7. Display the Bluetooth device screen on your Bluetooth device, and select “Roland V-160HD Audio.”

Once pairing is successful, the message on the V-160HD changes to “COMPLETE.”



8. Press the [MENU] button to close the menu.

### Connecting an Already-Paired Bluetooth Device

1. Turn on the Bluetooth function of the Bluetooth device.
2. Turn on the Bluetooth function of the V-160HD.

The onscreen STATUS display on the V-160HD changes to “CONNECTED” when the connection is successful.



\* If connection does not succeed, select “Roland V-160HD Audio” in the Bluetooth device screen on your Bluetooth device.

#### MEMO

- You can also check the (Bluetooth) indicator for the connection status.

Lit	Connected	Rapid blinking	Now pairing
Unlit	Bluetooth off	Blinking	Waiting for connection

- Pair again in the following cases:
  - When the pairing data has been deleted from the Bluetooth device
  - When the V-160HD has been reset to its factory-set state (p. 73).
- To remove the Bluetooth connection, deactivate Bluetooth on the V-160HD or on your Bluetooth device.
- You can assign a function to a USER button for switching Bluetooth on/off, or for pairing (p. 65).



# Connecting a Footswitch

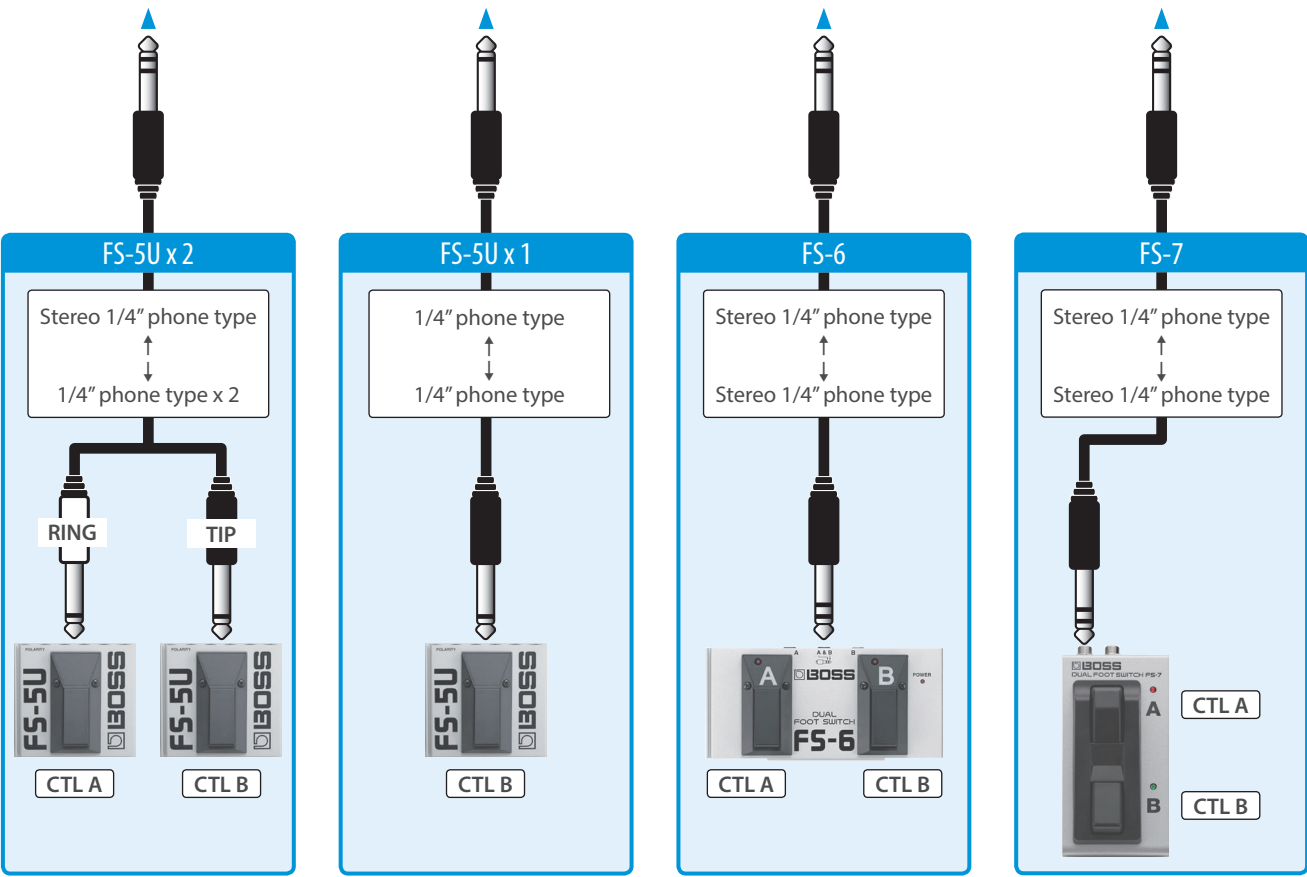
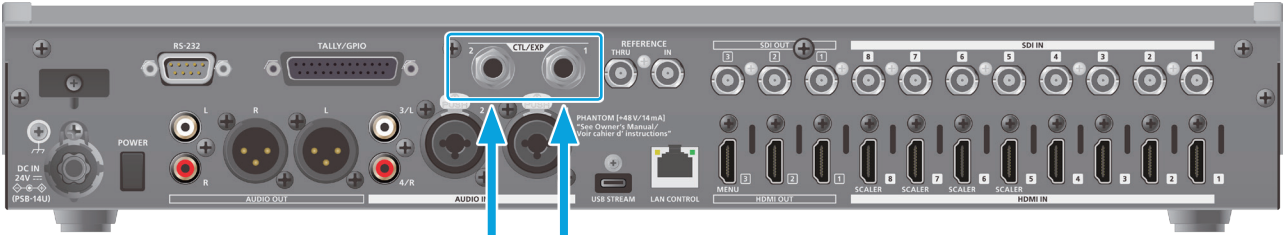

### MODE/POLARITY switch

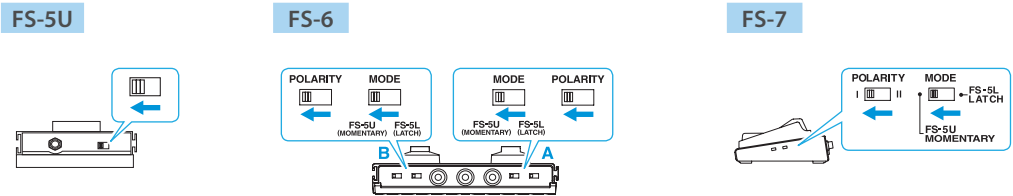

**NOTE**  
The BOSS FS-6's A, B, and A&B jacks also act as the power switch. The power turns on when you insert a plug into the jack, and turns off when you remove the plug.  
To prevent the batteries from running down, remove the plugs from the jacks when you're not using the BOSS FS-6.

# Basic Operations

## Turning the Power On/Off

\* Before turning the unit on/off, always be sure to turn the volume down. Even with the volume turned down, you might hear some sound when switching the unit on/off. However, this is normal and does not indicate a malfunction.

### Turning the Power On

1. Make sure that all devices are powered-off.
2. Press the V-160HD's [POWER] button to turn on the power.



3. Turn on the power in the order of source devices → output devices.

### Turning the Power Off

1. Turn off the power in the order of output devices → source devices.
2. Press the V-160HD's [POWER] button to turn off the power.

## Operating the Menu

Here's how to access the menu, and make video/audio settings and settings for this unit.

The menu is also appears on the display connected to the HDMI OUT 3 connector.

1. Press the [MENU] button to display the menu.

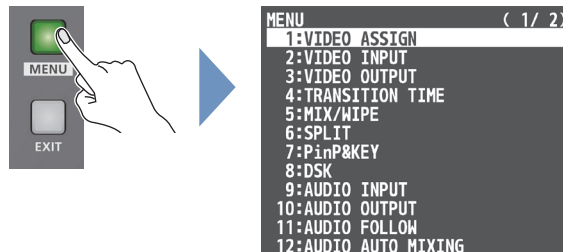

The menu is organized into functions.

2. Turn the [VALUE] knob to select the menu item that you want to edit, and press the [VALUE] knob to confirm.

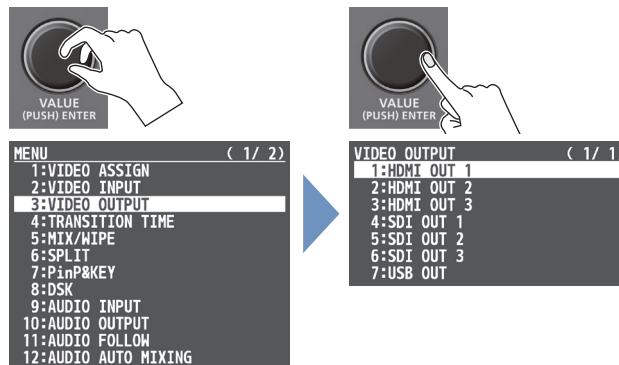

3. Repeat step 2 as needed.  
Pressing the [EXIT] button moves you back one level higher.
4. Turn the [VALUE] knob to change the setting value, and then press the [VALUE] knob to confirm.
  - By turning the [VALUE] knob while pressing it, you can change the value more greatly.
  - Long-pressing the [VALUE] knob returns the current menu item you're setting to its default value.
5. Press the [MENU] button to quit the menu.

## Switching the Monitor View

Aside from multi-view display, you can switch between videos to monitor such as the input video or a list of still images, according to your needs.

### 1. Press one of the MONITOR [1], [2], [3] or [4] buttons.

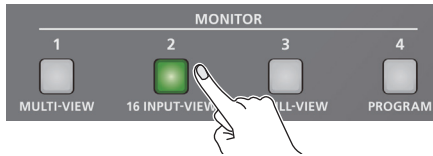

The selected button is lit, and both the display from the monitor of this unit and the output video from the HDMI OUT 3 connector switch at the same time.

\* The display from the monitor of this unit and the output from the HDMI OUT 3 connector always switch together.

### MONITOR [1] (MULTI-VIEW) button

The final output video, preview output video and the videos allocated to the cross-point [1]–[8] buttons are shown in sections of the display (multi-view).



#### 1 PVW (preview) section

Displays the preview output video (the video to be output next).

\* The fade-in/out effect (p. 26) is not reflected here.

#### 2 PGM (program) section

Displays the final output video.

#### 3 Cross-point [1]–[8] button video

Displays the video assigned to each cross-point button.

The final video output and preview output video are displayed with tally frames (red and green).

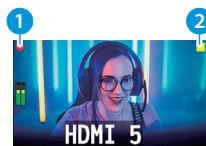

#### 1 REC indicator

If a camera that supports the REC status function is connected, this is shown when the camera's REC button is pressed.

#### 2 AUX/SOURCE indicator

This displays as follows.

Yellow	PinP & KEY inset screen
Magenta	DSK video source
Green	AUX bus video source

### MONITOR [2] (16 INPUT-VIEW) button

The input video from the HDMI IN connectors and the SDI IN connectors are shown as 16 separate sections on the screen.

### MONITOR [3] (16 STILL-VIEW) button

Shows the loaded still images in 16 separate sections on the screen.

### MONITOR [4] (PROGRAM) button

Shows the final output video.

## Audio level meter indication



- You can set the audio level meter to show or hide. You can also individually set where each audio level meter in the multi-view is displayed.

Configure the settings of the following menu items from the [MENU] button → "SYSTEM."

Menu item	Explanation
AUDIO LEVEL METER	Sets whether to show or hide the audio level meter.
MASTER OUTPUT	
AUX	
USB OUT	Sets the display position of the audio level meter.
AUDIO IN/USB/Bluetooth	When this is "OFF," the level meter is always hidden.

- The following status marks are shown below the audio level meter.

MT	The mute function (p. 44) is on.
A.F	The audio follow function (p. 43) is on.

\* This is not shown on this unit's display.

### MEMO

- You can change the monitoring videos assigned to the MONITOR [1]–[4] buttons.  
To make this setting, use the [MENU] button → "SYSTEM" → "MONITOR SW ASSIGN" → "MONITOR 1 SW" – "MONITOR 4 SW."
- Items shown on the monitor**  
You can individually set whether items like the tally frame, label and so on are shown or hidden.  
Configure the settings of the following menu items from the [MENU] button → "SYSTEM."

Menu item	Explanation
TALLY FRAME	Tally frame
AUX/SOURCE INDICATOR	AUX/SOURCE indicator
REC INDICATOR	REC indicator
AUDIO LEVEL METER	Audio level meter
MULTI-VIEW LABEL	Label

- You can change the label names that are shown in the monitor.  
Edit this from the [MENU] button → "SYSTEM" → "MULTI-VIEW LABEL EDIT."
- For details on the cameras that support the REC status function, refer to the Roland website.

<https://proav.roland.com/>

# Video Input/Output Settings

## Setting the Video Input/Output Format

Here's how to specify the input/output format as appropriate for the device that's connected.

### Setting the System Format

On the V-160HD, the input/output format is determined according to the system format. You set the input/output format to match the connected equipment.

System format	Input format (*1)	Output format (*2)
	HDMI IN 1-4 connectors SDI IN 1-8 connectors	HDMI OUT 1 and 2 connectors SDI OUT 1-3 connectors
1080p	1080p, 1080i	1080p
1080i	1080p, 1080i	1080i
720p	720p	720p

(\*1) You can specify separate individual input formats for the HDMI IN 5-8 connectors, regardless of the system format.

For details, refer to "Setting the Input Format for the HDMI IN 5-8 Connectors" on this page.

(\*2) The output format at the HDMI OUT 3 connector is fixed at "1080p."

1. [MENU] button → "SYSTEM" → select "SYSTEM FORMAT," and press the [VALUE] knob.

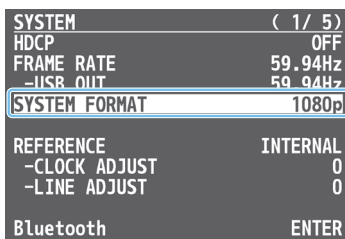

2. Use the [VALUE] knob to select "1080p," "1080i," or "720p," and press the [VALUE] knob.

\* A change in the setting is not applied until you press the [VALUE] knob to confirm.

3. Press the [MENU] button to close the menu.

### Internal processing

The V-160HD's internal processing is progressive. Interlaced input video is automatically converted to a progressive signal.

The video might appear jagged at this time, or the video in a PinP inset screen or on the multi-view might waver.

This is due to progressive conversion, and is not a malfunction.

### About frame rate

The frame rates "59.94 Hz," "60 Hz," and "50 Hz" are supported for output video.

To make this setting, use the [MENU] button → "SYSTEM" → "FRAME RATE."

\* You can set the frame rate for USB output from the [MENU] button → "SYSTEM" → FRAME RATE "USB OUT."

### Setting the Input Format for the HDMI IN 5-8 Connectors

Using the factory settings, the EDID assignment for the HDMI IN 5-8 connectors is "INTERNAL" (so that EDID values of all formats that can be input are sent).

To specify an input format of your choice, change the setting of the EDID information being sent so that it matches the incoming video signal.

#### What is EDID?

EDID is data that is transmitted from the V-160HD to the source device when the V-160HD is connected to a source device. EDID contains data such as the formats that can be input to the V-160HD (resolution, color space, color depth) and audio information.

Based on the EDID information that the source device receives, it will output the most appropriate video format to the V-160HD.

1. [MENU] button → "VIDEO INPUT" → "HDMI IN 5 (SCALER)" → "HDMI IN 8 (SCALER)" → select "EDID," and press the [VALUE] knob.

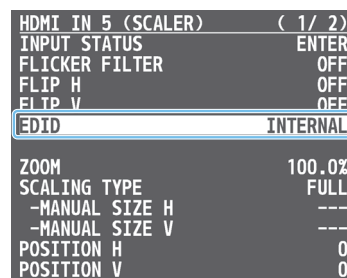

2. Use the [VALUE] knob to set the input format (the EDID information to send), and press the [VALUE] knob.

\* A change in the setting is not applied until you press the [VALUE] knob to confirm.

Value	
INTERNAL (EDID information for all inputtable formats is sent.)	
SXGA+ (1400 x 1050)	UXGA (1600 x 1200)
SVGA (800 x 600)	WUXGA (1920 x 1200)
XGA (1024 x 768)	720p
WXGA (1280 x 800)	1080i
FWXGA (1366 x 768)	1080p
SXGA (1280 x 1024)	

3. Press the [MENU] button to close the menu.

## Assigning Video Sources

Here's how to assign the video sources (input video and still images) to the cross-point [1]–[10] buttons.

### Using the buttons

1. Press a cross-point button while holding down the [INPUT ASSIGN] button.

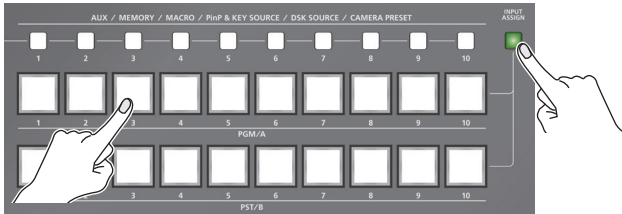

The video source changes in the following order each time you press the button.

#### [INPUT ASSIGN] + PGM/A cross-point buttons

STILL 16 → 1 → SDI 8 → 1 → HDMI 8 → 1

#### [INPUT ASSIGN] + PST/B cross-point buttons

HDMI 1 → 8 → SDI 1 → 8 → STILL 1 → 16

### Using the menus

1. [MENU] button → "VIDEO ASSIGN" → select "INPUT 1"–"INPUT 10," and press the [VALUE] knob.

VIDEO ASSIGN ( 1 / 2 )	
INPUT 1	HDMI 1
INPUT 2	HDMI 2
INPUT 3	HDMI 3
INPUT 4	HDMI 4
INPUT 5	HDMI 5
INPUT 6	HDMI 6
INPUT 7	HDMI 7
INPUT 8	HDMI 8
INPUT 9	STILL 1
INPUT 10	STILL 2

2. Use the [VALUE] knob to select the video source, and press the [VALUE] knob.
3. Press the [MENU] button to close the menu.

#### MEMO

You can import still images by using the following methods.

- ➔ "Loading a Still Image from a USB Flash Drive" (p. 22)
- ➔ "Capturing a Still Image from Input/Output Video" (p. 23)

## Adjusting Output Video

Here's how to adjust the output image appropriately for the device that's receiving the V-160HD's output.

1. [MENU] button → "VIDEO OUTPUT" → select "HDMI OUT 1–3" or "SDI OUT 1–3," and press the [VALUE] knob.

VIDEO OUTPUT ( 1 / 1 )	
1: HDMI OUT 1	
2: HDMI OUT 2	
3: HDMI OUT 3	
4: SDI OUT 1	
5: SDI OUT 2	
6: SDI OUT 3	
7: USB OUT	

2. Use the [VALUE] knob to select a menu item shown below, and press the [VALUE] knob.

### HDMI OUT 1–3

HDMI OUT 1 ( 1 / 1 )	
OUTPUT STATUS	NOT CONNECTED
COLOR SPACE	YPbPr(4:4:4)
DVI-D/HDMI SIGNAL	HDMI
BRIGHTNESS	0
CONTRAST	0
SATURATION	0
RED	0
GREEN	0
BLUE	0
REC CONTROL	ON

Value	Explanation
OUTPUT STATUS	Shows the format and an HDCP signal presence.
COLOR SPACE	Specifies the color space.
DVI-D/HDMI SIGNAL	Specifies the type of output signal.
BRIGHTNESS	Adjusts the brightness.
CONTRAST	Adjusts the contrast.
SATURATION	Adjusts the saturation.
RED	Adjusts the red level.
GREEN	Adjusts the green level.
BLUE	Adjusts the blue level.

### SDI OUT 1–3

SDI OUT 1 ( 1 / 1 )	
OUTPUT STATUS	1080/59.94p
3G-SDI MAPPING	LEVEL-B
BRIGHTNESS	0
CONTRAST	0
SATURATION	0

Value	Explanation
OUTPUT STATUS	Shows the format.
3G-SDI MAPPING	Specifies the mapping structure of the 3G-SDI output.
BRIGHTNESS	Adjusts the brightness.
CONTRAST	Adjusts the contrast.
SATURATION	Adjusts the saturation.

3. Use the [VALUE] knob to edit the value of the setting, and press the [VALUE] knob.
4. Press the [MENU] button to close the menu.

#### MEMO

You can output a test pattern, useful for adjusting the image quality of a display.

Use the [MENU] button → "SYSTEM" → "TEST PATTERN" to specify the test pattern.

## Adjusting Input Video

Here's how to adjust the quality of the input video signals.  
For the HDMI IN 5–8 connectors, you can also adjust the scaling.

1. [MENU] button → “VIDEO INPUT” → select “HDMI IN 1–8 (SCALER)” or “SDI IN 1–8,” and press the [VALUE] knob.

VIDEO INPUT ( 1 / 2 )	VIDEO INPUT ( 2 / 2 )
1:HDMI IN 1	9:SDI IN 1
2:HDMI IN 2	10:SDI IN 2
3:HDMI IN 3	11:SDI IN 3
4:HDMI IN 4	12:SDI IN 4
5:HDMI IN 5 (SCALER)	13:SDI IN 5
6:HDMI IN 6 (SCALER)	14:SDI IN 6
7:HDMI IN 7 (SCALER)	15:SDI IN 7
8:HDMI IN 8 (SCALER)	16:SDI IN 8

2. Use the [VALUE] knob to select a menu item shown below, and press the [VALUE] knob.

HDMI IN 1 ( 1 / 1 )
INPUT STATUS ENTER
FLIP H OFF
FLIP V OFF
BRIGHTNESS 0
CONTRAST 0
SATURATION 0

Menu item	Explanation
INPUT STATUS	Displays information about the incoming video.
FLIP H	When this is “ON,” the video is input with left and right flipped.
FLIP V	When this is “ON,” the video is input with top and bottom flipped.
BRIGHTNESS	Adjusts the brightness.
CONTRAST	Adjusts the contrast.
SATURATION	Adjusts the saturation.

\* The following parameters are only for HDMI IN 5–8 (SCALER).

FLICKER FILTER	When this is “ON,” flickering is reduced.
EDID	Specifies the input format (EDID) (p. 12).
ZOOM	Adjusts the zoom ratio.
SCALING TYPE	Specifies the scaling type.
MANUAL SIZE H	Adjusts the horizontal size when scaling type is set to “MANUAL.”
MANUAL SIZE V	Adjusts the vertical size when scaling type is set to “MANUAL.”
POSITION H	Adjusts the position in the horizontal direction.
POSITION V	Adjusts the position in the vertical direction.
RED	Adjusts the red level.
GREEN	Adjusts the green level.
BLUE	Adjusts the blue level.

3. Use the [VALUE] knob to edit the value of the setting, and press the [VALUE] knob.
4. Press the [MENU] button to close the menu.

## Assigning Video Buses to Output Connectors

The V-160HD features seven types of video buses. You can respectively assign the video bus you like to the HDMI OUT and SDI OUT connectors as well as the USB STREAM port.

Video bus	Explanation
PROGRAM	Final output video
SUB PROGRAM	Same video as the PROGRAM bus The SUB PROGRAM bus lets you set whether to display or hide the PinP & key layers and the DSK layers, separately from the PROGRAM bus. You can edit the layer settings to output a different video from that of the PROGRAM bus.
PREVIEW	Preview output video (the video to be output next) * The fade-in/out effect (p. 26) is not reflected here.
AUX	Video of your choice sent to the AUX bus (p. 15) This lets you allocate a separate output that is independent of the final output, such as when you want a specific input video to be a fixed output.
MULTI-VIEW	The final output video, preview output video and the videos allocated to the cross-point [1]–[8] buttons (multi-view)
16 INPUT-VIEW	The input video from the HDMI IN and SDI IN connectors (shown as 16 separate sections on the screen)
16 STILL-VIEW	Still images loaded into the unit (shown as 16 separate sections on the screen)

1. [MENU] button → “VIDEO ASSIGN” → select “HDMI OUT 1–3,” “SDI OUT 1–3,” or “USB OUT,” and press the [VALUE] knob.

VIDEO ASSIGN ( 2 / 2 )	
HDMI OUT 1	PROGRAM
HDMI OUT 2	PREVIEW
HDMI OUT 3	16 STILL-VIEW
SDI OUT 1	PROGRAM
SDI OUT 2	PREVIEW
SDI OUT 3	MULTI-VIEW
USB OUT	PROGRAM
AUX SOURCE	HDMI 1
PROGRAM LAYER	ENTER
SUB PROGRAM LAYER	ENTER

2. Use the [VALUE] knob to select the video bus that you want to assign, and press the [VALUE] knob.
3. Press the [MENU] button to close the menu.

### MEMO

- The tally frame, audio level meter, label and so on are shown only for the output from the HDMI OUT 3 connector.
- When you change the video bus assigned to the HDMI OUT 3 connector, the display on the monitor of this unit changes as well.

## About audio outputs assigned to video buses

You can also assign the desired audio buses (MASTER OUTPUT, AUX) for each jack, apart from the video bus (p. 45).

### ● Audio output from the HDMI OUT and SDI OUT connectors

The audio bus assignments automatically change according to the video bus as shown below with the factory settings.

Video bus	Audio bus
Others besides AUX	MASTER OUTPUT
AUX	AUX

## Selecting the Video Sent to the AUX Bus

Here's how to send the video of your choice to the AUX bus. This lets you allocate a separate output that is independent of the final output, such as when you want a specific input video to be a fixed output.

### 1. Press the [MODE] button several times to select "AUX"

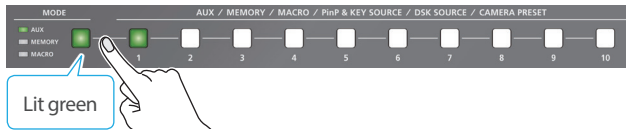

### 2. Press a AUX [1]–[10] buttons to select the video that is sent to the AUX bus.

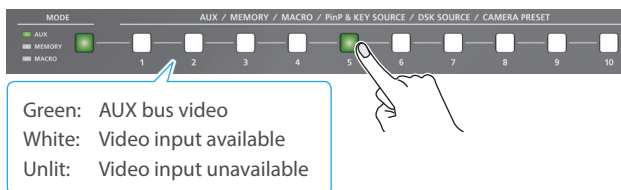

The video is switched for the output connector to which the AUX bus is assigned.

\* When selecting a video not assigned to INPUT 1–10, set this from the [MENU] button → "VIDEO ASSIGN" → "AUX SOURCE."

#### MEMO

- With the default factory settings, the audio is automatically sent to the AUX bus (audio bus) in tandem with the video selection. You can adjust how much audio is sent to the AUX bus.

#### • Sending the same video as the final output to the AUX bus (AUX link)

You can use the AUX link function to send the same video as the final output video to the AUX bus. The video sent to the AUX bus automatically switches in tandem with the video transitions.

From the [MENU] button → "SYSTEM," set the "AUX LINKED PGM" to "AUTO LINK" or "MANUAL LINK" (p. 101).

## Inputting Copy-Protected (HDCP) Video

If you want to input HDCP-protected video from a BD player or other device, you can enable HDCP input.

\* If you want to output copy-protected (HDCP) video or audio, connect a device that supports HDCP.

### What's HDCP?

HDCP is copyright-protection technology that prevents unlawful copying of content by encoding the path when sending digital signals from a video playback device to a display monitor or other display equipment.

### 1. [MENU] button → "SYSTEM" → select "HDCP," and press the [VALUE] knob.

SYSTEM	( 1 / 5 )
HDCP	OFF
FRAME RATE	59.94Hz
-USB OUT	59.94Hz
SYSTEM FORMAT	1080p
REFERENCE	INTERNAL
-CLOCK ADJUST	0
-LINE ADJUST	0
Bluetooth	ENTER

### 2. Use the [VALUE] knob to select "ON," and press the [VALUE] knob.

Value	Explanation
ON	Copy-protected (HDCP) video can be input. HDCP is also added to the video that is output. * Video/audio from the SDI OUT connectors and the USB STREAM port are not outputted.
OFF	Copy-protected (HDCP) video cannot be input.

\* A change in the setting is not applied until you press the [VALUE] knob to confirm.

### 3. Press the [MENU] button to close the menu.

## Checking for HDCP-capable devices

### Source devices

You can check the HDCP support status of the source device from the menu.

Use the [MENU] button → "VIDEO INPUT" → "HDMI IN 1–8 (SCALER)" → "INPUT STATUS" to display the HDCP status.

When inputting copy-protected (HDCP) video, "DETECT" is displayed.

HDMI IN 1	( 1 / 1 )
STATUS:	DETECTED
H PIXELS:	1920
V PIXELS:	1080
FRAME RATE:	59.94Hz
SCAN TYPE:	PROGRESSIVE
HDCP:	DETECTED

### Output devices

If a device that supports HDCP is connected, "HDCP" is displayed when you press the [MENU] button and select "VIDEO OUTPUT" → "HDMI OUT 1–3" → "OUTPUT STATUS."

## Specifying a Reference Clock

You can specify a clock to which operation of the V-160HD is referenced (a reference clock).

1. [MENU] button → “SYSTEM” → select “REFERENCE,” and press the [VALUE] knob.

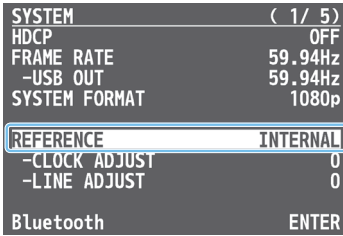

2. Use the [VALUE] knob to specify the reference clock, and press the [VALUE] knob.

Value	Explanation
INTERNAL	The V-160HD's internal clock is used as the reference clock.
EXTERNAL	A synchronizing signal input via the REFERENCE IN connector is used as the reference clock. Black-burst (frame synchronization), bi-level, and tri-level synchronizing signals are supported.
SDI 1-8	A signal input via one of the SDI IN 1-8 connectors is used as the reference clock. The VSYNC (vertical synchronizing) signal output from the V-160HD is synchronized to the VSYNC signal input via SDI.

- **When set to “EXTERNAL” or “SDI 1-8”**

Adjust the following menu items as needed.

Menu item	Explanation
CLOCK ADJUST	This adjusts the phase horizontally. Adjust this when output is horizontally out of sync with the operation of other devices using the same clock.
LINE ADJUST	This adjusts the phase vertically. Adjust this when output is vertically out of sync with or field-shifted from the operation of other devices using the same clock.

3. Press the [MENU] button to close the menu.



# Video Operations

## Switching the Video

You can switch between the videos of the PGM/A bus and PST/B bus to specify the final output.

### Setting the Operation Mode

There are two operation modes for switching the video: the “PGM/PST mode” and the “A/B mode.”

Video on the PGM/A bus



Video on the PST/B bus

#### PGM/PST mode (factory settings)

The video on the PGM/A bus is always the final output. The video on the PST/B bus is preview output video (the video to be output next).

Operating the video fader or the [CUT] or [AUTO] button makes the final video output and the preview output video change places.

#### A/B mode

When you operate the video fader, the video of the bus toward which the video fader is flipped always becomes the final output. The video of the other bus becomes the preview output video (the video that is output next).

When the [CUT] or [AUTO] button is operated, the video on the PGM/A bus and the video on the PST/B bus become the final output in alternation.

1. Press the [MENU] button → “SYSTEM” → select “PANEL OPERATION,” and press the [VALUE] knob.

SYSTEM	( 2 / 5 )
PANEL OPERATION	PGM/PST
EFFECTS TRANSITION SYNC	OFF
EFFECTS SPOT	ENABLE
PANEL LOCK	ENTER
AUX LINKED PGM	OFF
CUT SW ASSIGN	---
AUTO SW ASSIGN	---
OUTPUT FADE ASSIGN	
-VIDEO FADE	BLACK
-AUDIO FADE	ENABLE
USER SW ASSIGN	ENTER
MONITOR SW ASSIGN	ENTER

2. Use the [VALUE] knob to select “A/B” or “PGM/PST,” and press the [VALUE] knob.
3. Press the [MENU] button to close the menu.

### Switching in the PGM/PST Mode

Here are the steps when selecting “PGM/PST mode” in the operation mode settings.

1. Flip the video fader all the way upward or downward.



The video on the PGM/A bus is the final output. When the video fader is pushed all the way down, only the topmost or bottommost transition indicator lights.

2. Press a PST/B cross-point [1]–[10] button to select the preview output video (the video to be output next).

You can check the preview output video in the PVW section of the multi-view.

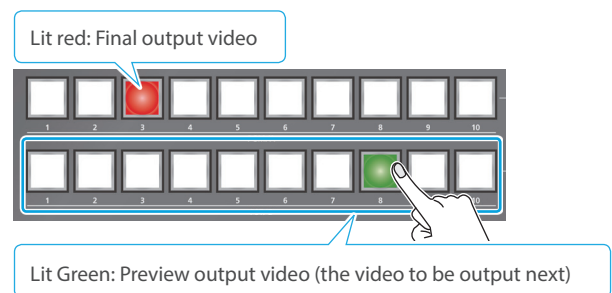

3. Press the [TRANSITION] button to select the transition effect (MIX, WIPE).



#### Mix

The two videos are mixed as the transition occurs.



#### Wipe

The next video moves across to replace the original video.



### Using the buttons to switch

4. Press the [AUTO] or [CUT] button.

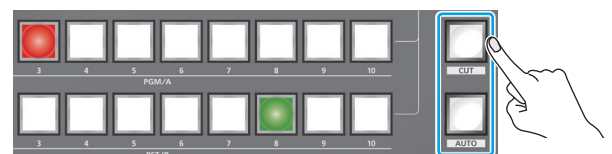

Button	Explanation
[CUT]	The picture switches instantly.
[AUTO]	The video is switched automatically. The [AUTO] button flashes while the video transition is in progress. To specify the video transition time, use the [MENU] button → “TRANSITION TIME” → “MIX/WIPE TIME.”

## Using the fader to switch

4. Move the video fader in the direction opposite to the direction in step 1.



The video is switched according to the movement of the video fader.

### MEMO

- You can change the transition pattern used for a wipe or mix transition.
  - ➔ "Changing the Mix/Wipe Pattern" (p. 19)
- When you use the [AUTO] or [CUT] button to switch video, the actual output might come to differ from the position of the video fader.
 

If you operate the video fader in this state, the output does not change until the position of the video fader matches the actual output.

## Switching in the A/B Mode

Here are the steps when selecting "A/B mode" (p. 17) in the operation mode settings.

1. Flip the video fader all the way upward or downward.



The video of the bus toward which you pull down the video fader becomes the final output.

2. Press a cross-point [1]–[10] button at the end to which the video fader is not flipped to select the preview output video (the video to output next).

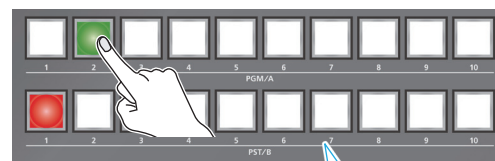

Lit red: Final output video  
Lit Green: Preview output video (the video to be output next)

3. Press the [TRANSITION] button to select the transition effect (MIX, WIPE).

### Using the buttons to switch

4. Press the [AUTO] or [CUT] button.

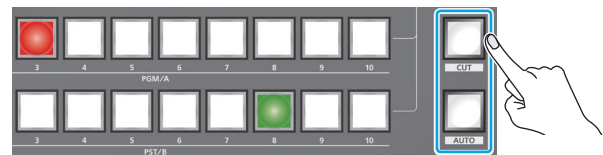

Button	Explanation
[CUT]	The picture switches instantly.
[AUTO]	The video is switched automatically. The [AUTO] button flashes while the video transition is in progress. To specify the video transition time, use the [MENU] button → "TRANSITION TIME" → "MIX/WIPE TIME."

### Using the fader to switch

4. Move the video fader in the direction opposite to the direction in step 1.

The video is switched according to the movement of the video fader.

### MEMO

- You can change the transition pattern used for a wipe or mix transition.
  - ➔ "Changing the Mix/Wipe Pattern" (p. 19)
- You can change what happens when you press the [CUT] and [AUTO] buttons.
  - ➔ "Changing the Functions of the [CUT] and [AUTO] Buttons" (p. 19)
- When you use the [AUTO] or [CUT] button to switch video, the actual output might come to differ from the position of the video fader.
 

If you operate the video fader in this state, the output does not change until the position of the video fader matches the actual output.

## Changing the Mix/Wipe Pattern

You can change the transition pattern by which the mix/wipe occurs and the direction of the wipe.

1. [MENU] button → select “MIX/WIPE,” and press the [VALUE] knob.

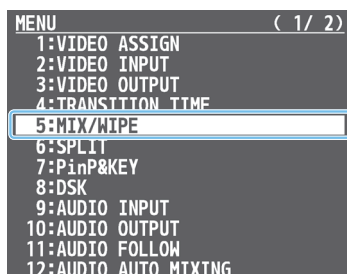

2. Use the [VALUE] knob to select a menu item shown below, and press the [VALUE] knob.

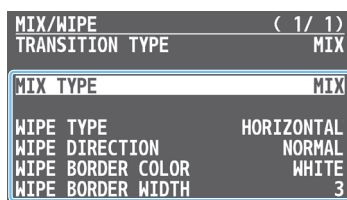

Menu item	Explanation
MIX TYPE	Specifies the transition pattern for mix.
WIPE TYPE	Specifies the transition pattern for wipe.
WIPE DIRECTION	Specifies the direction of wipe.
WIPE BORDER COLOR	Specifies the color of the border added to the edge of the wipe area.
WIPE BORDER WIDTH	Specifies the width of the border added to the edge of the wipe area.

3. Use the [VALUE] knob to change the value of the setting, and press the [VALUE] knob.
4. Press the [MENU] button to close the menu.

### MEMO

You can change the settings of the MIX/WIPE menu by holding down the [TRANSITION] button and turning the [PGM/A-CENTER] or [PST/B-CENTER] knob.

#### When mix is selected

Operation	Explanation
[TRANSITION] + [PGM/A-CENTER]	MIX TYPE

#### When wipe is selected

Operation	Explanation
[TRANSITION] + [PGM/A-CENTER]	WIPE TYPE
[TRANSITION] + [PST/B-CENTER]	WIPE DIRECTION
[TRANSITION] + [PGM/A-CENTER] (Turn while pressing)	WIPE BORDER COLOR
[TRANSITION] + [PST/B-CENTER] (Turn while pressing)	WIPE BORDER WIDTH

## Changing the Functions of the [CUT] and [AUTO] Buttons

You can change what happens when you press the [CUT] and [AUTO] buttons.

\* In PGM/PST mode (p. 17), the functions of the [CUT] and [AUTO] buttons are fixed.

1. [MENU] button → “SYSTEM” → select “CUT SW ASSIGN” or “AUTO SW ASSIGN,” and press the [VALUE] knob.

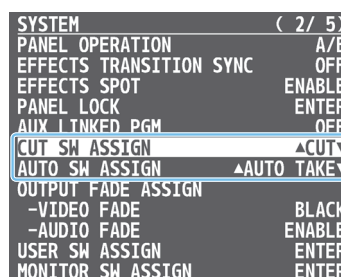

2. Use the [VALUE] knob to select a function of the button, and press the [VALUE] knob.

Value	Explanation
<b>CUT SW ASSIGN</b>	
▲AUTO TAKE	When the video of the PST/B bus is selected, switches to the video of the PGM/A bus.
▲AUTO TAKE▼	Switches the video between PGM/A bus and PST/B bus.
▲CUT	When the video of the PST/B bus is selected, switches to the video of the PGM/A bus as a cut.
▲CUT▼	Switches the video between PGM/A bus and PST/B bus as a cut.
▲TRANSFORM	When the video of the PST/B bus is selected, switches to the video of the PGM/A bus as a cut only while you're holding down the button.
<b>AUTO SW ASSIGN</b>	
AUTO TAKE▼	When the video of the PGM/A bus is selected, switches to the video of the PST/B bus.
▲AUTO TAKE▼	Switches the video between PGM/A bus and PST/B bus.
CUT▼	When the video of the PGM/A bus is selected, switches to the video of the PST/B bus as a cut.
▲CUT▼	Switches the video between PGM/A bus and PST/B bus as a cut.
TRANSFORM▼	When the video of the PGM/A bus is selected, switches to the video of the PST/B bus as a cut only while you're holding down the button.

3. Press the [MENU] button to close the menu.

## Switching the Video Automatically (Auto Switching)

The video of INPUT 1–10 or of preset memories (p. 48) can be switched automatically (the auto switching function). You can make operation easier by letting the video switch automatically.

### About the Operation Mode

Auto switching provides three operation modes that you can select as appropriate for your situation: “input scan,” “preset memory scan,” and “BPM sync.”

#### Switching at a specified interval (Input scan)

This automatically switches the INPUT 1–10 video when a specified length of time elapses. You can change the duration that each video is shown, and also switch randomly between videos.

This is convenient when you want to switch between video signals of multiple cameras, for example when live-streaming a singer-instrumentalist.

\* If there is no video input, this is skipped.

#### Switching preset memories (Preset memory scan)

This automatically recalls between preset memories 1–30. The video and audio are switched according to the settings that are saved in each preset memory.

\* Preset memories in which no settings have been saved are skipped.

#### Switching in synchronization with the BPM (BPM sync)

This automatically switches the video at specified BPM intervals. This lets you create video transitions that are synchronized with the music, for example when live-streaming a DJ performance or a musical performance.

## Turning the Auto Switching Function On/Off

1. [MENU] button → “AUTO SWITCHING” → select “AUTO SWITCHING,” and press the [VALUE] knob.

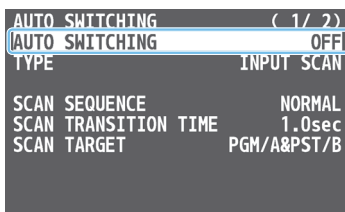

2. Use the [VALUE] knob to select “ON” or “OFF.”
3. Press the [MENU] button to close the menu.

#### MEMO

You can assign the function to a USER button and turn auto switching on/off (p. 65).  
The on/off function for auto-switching is assigned to the USER [2] button by factory default.

### Setting the Operation Mode

#### Input scan

1. [MENU] button → “AUTO SWITCHING” → select “TYPE,” and press the [VALUE] knob.

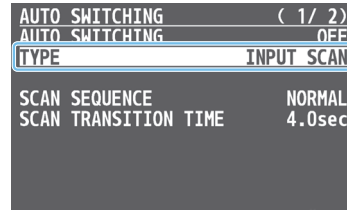

2. Use the [VALUE] knob to select “INPUT SCAN,” and press the [VALUE] knob.
3. Use the [VALUE] knob to select a menu item shown below, and press the [VALUE] knob.

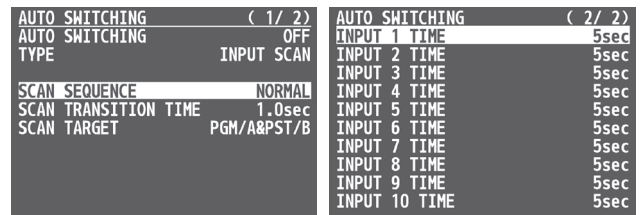

Menu item	Explanation
SCAN SEQUENCE	Specifies the order in which video signals are shown. <b>NORMAL:</b> Switches in the order of INPUT 1→10. <b>REVERSE:</b> Switches in the order of INPUT 10→1. <b>RANDOM:</b> Switches randomly.
SCAN TARGET	Sets the video to which auto switching is applied. <b>PGM/A &amp; PST/B:</b> Final output video and preview video <b>PinP &amp; KEY 1–4:</b> PinP and key layer (inset screen) video
SCAN TRANSITION TIME	Specifies the video transition time.
INPUT 1–10 TIME	Specifies the time that the video is shown. Turn this “OFF” to skip.

4. Use the [VALUE] knob to change the value of the setting.
5. Press the [MENU] button to close the menu.

**Preset memory scan**

1. [MENU] button → “AUTO SWITCHING” → select “TYPE,” and press the [VALUE] knob.

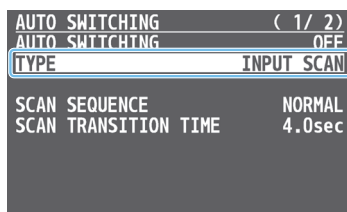

2. Use the [VALUE] knob to select “PRESET MEMORY SCAN,” and press the [VALUE] knob.
3. Use the [VALUE] knob to select a menu item shown below, and press the [VALUE] knob.

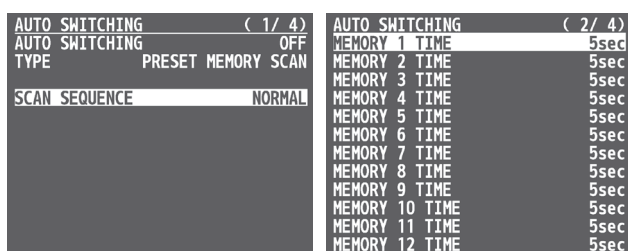

Menu item	Explanation
SCAN SEQUENCE	Specifies the order in which preset memories are switched.  <b>NORMAL:</b> Switches in the order of preset memory 1→30.  <b>REVERSE:</b> Switches in the order of preset memory 30→1.  <b>RANDOM:</b> Switches randomly.
MEMORY 1–30 TIME	Specifies the time it takes to switch to the next preset memory. Turn this “OFF” to skip.

4. Use the [VALUE] knob to change the value of the setting.
5. Press the [MENU] button to close the menu.

**BPM sync**

1. [MENU] button → “AUTO SWITCHING” → select “TYPE,” and press the [VALUE] knob.

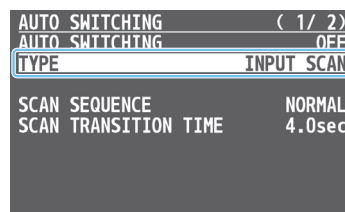

2. Use the [VALUE] knob to select “BPM SYNC,” and press the [VALUE] knob.
3. Use the [VALUE] knob to select a menu item shown below, and press the [VALUE] knob.



Menu item	Explanation
BPM	Specifies the BPM.
MODE	Specifies how the video is switched.  <b>TRANSITION:</b> The video switches using the currently selected transition effect (mix or wipe).  <b>CUT:</b> The video switches as a cut.
SPEED	Specifies the video switching speed as a multiple of the specified BPM.

4. Use the [VALUE] knob to change the value of the setting.
5. Press the [MENU] button to close the menu.

**MEMO**

By assigning the “BPM TAP” function for auto-switching to a USER button (p. 65), you can set the BPM according to the tempo at which you press the button.

The USER buttons blink in sync with the current BPM setting.

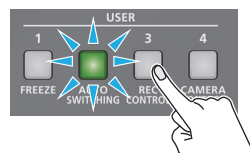

## Loading a Still Image

You can load a still image, and output it in the same way as video (p. 25) or use it as a source for DSK compositing (p. 30). There are two ways to load a still image: you can load from a USB flash drive, or you can capture from input video.

You can save up to sixteen still images in the unit.

\* When still images are saved in the unit, startup takes longer time according to image size and the number of still images saved.

### Loading a Still Image from a USB Flash Drive

Here's how to load a still image from a USB flash drive into the unit.

**NOTE**

- Still images cannot be scaled. In advance, you must prepare still images of the resolution that is appropriate for your output format.
- When using a USB flash drive for the first time, you must format it using the V-160HD (p. 64).
- Never turn off the power or remove the USB flash drive while the message "PLEASE WAIT" is shown.
- Depending on the USB flash drive, recognition of the flash drive might take some time.

### Formats supported for loading

Format	Bitmap File (.bmp), 24-bit color, uncompressed
	PNG file (.png), 24-bit color * Alpha channel supported
	JPEG File (.jpg), 24-bit color
Resolution	In conformity with system format
File name	No more than 64 single-byte alphanumeric characters * The extension ".bmp", ".png," or ".jpg" must be added.

### Loading a still image

1. Save the still image in the root directory of the USB flash drive.
2. Connect the USB flash drive containing the still image to the USB MEMORY port.
3. [MENU] button → "STILL IMAGE" → select "LOAD FROM USB MEMORY," and press the [VALUE] knob.

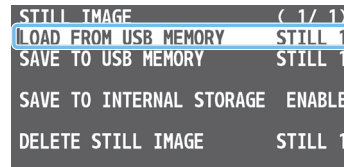

A "\*" symbol is displayed for memory where a still image is already saved.

4. Use the [VALUE] knob to select the loading destination for the still image (STILL 1–16), and press the [VALUE] knob. A list of the still images in the USB flash drive is shown.
5. Use the [VALUE] knob to select the still image file you want to load, and press the [VALUE] knob. A confirmation message appears.

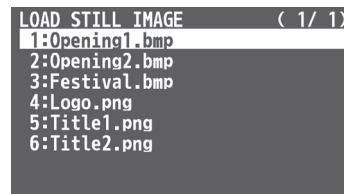

\* If you decide to cancel, press the [EXIT] button.

6. Use the [VALUE] knob to select "YES," and press the [VALUE] knob.

The still image is loaded into the unit. When the operation is finished, the message "COMPLETE" appears.

\* Large-size still-image files and PNG files might take some time to load.

7. Press the [MENU] button to close the menu.

**MEMO**

You can set the method of saving still images to "temporarily save." When you turn off the power, the loaded still image is deleted.

From the [MENU] button → "STILL IMAGE," set "SAVE TO INTERNAL STORAGE" to "DISABLE," and then load the still image.

## Capturing a Still Image from Input/Output Video

Here's how to capture a still image from the input/output video.

1. Press the [CAPTURE IMAGE] button to turn on (lit).

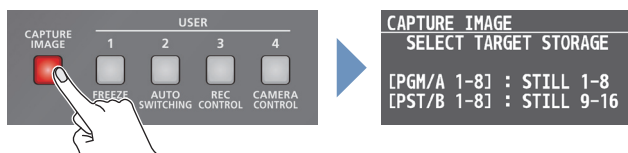

CAPTURE IMAGE screen appears, and the cross-point [1]–[8] buttons blink yellow.

2. Press a PGM/A or PST/B cross-point [1]–[8] button to select a save destination memory (STILL 1–16) for the captured still image.

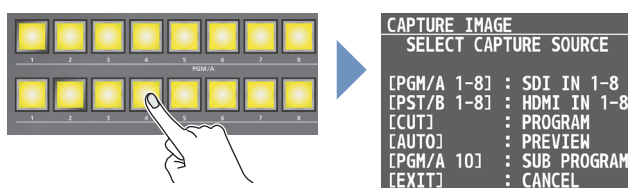

### ● Button assignments

PGM/A cross-point [1]–[8]	STILL 1–8
PST/B cross-point [1]–[8]	STILL 9–16

\* If you decide to cancel, press the [EXIT] button.

3. Press a button that is blinking red to select the input/output video from which you want to capture.

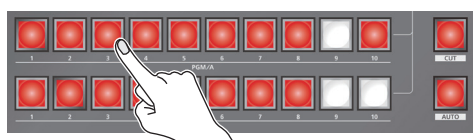

### ● Button assignments

PGM/A cross-point [1]–[8]	SDI IN 1–8
PST/B cross-point [1]–[8]	HDMI IN 1–8
[CUT]	Final output
[AUTO]	Preview output
PGM/A cross-point [10]	SUB PROGRAM bus

The capture is executed. When the operation is finished, the message "COMPLETE" appears.

4. Press the [CAPTURE IMAGE] button to exit the operation.

### MEMO

- You can set the method of saving still images to "temporarily save." When you turn off the power, the captured still image is deleted.  
From the [MENU] button → "STILL IMAGE," set "SAVE TO INTERNAL STORAGE" to "DISABLE," and then capture the image.
- Depending on the format of the input video, completion of still-image capture might take some time.
- If you capture when HDCP (p. 15) is on, the still image that is created is handled in the same way as HDCP-protected video. It cannot be used if HDCP is off.

## Deleting a Still Image

Here's how to delete the still image that's saved in the unit.

1. [MENU] button → "STILL IMAGE" → select "DELETE STILL IMAGE," and press the [VALUE] knob.

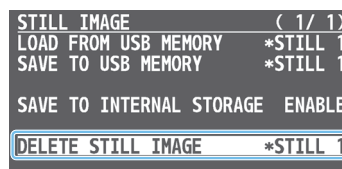

2. Use the [VALUE] knob to select the still image (ALL, STILL 1–16) you want to delete, and press the [VALUE] knob.

A confirmation message appears.



\* If you decide to cancel, press the [EXIT] button.

3. Use the [VALUE] knob to select "YES," and press the [VALUE] knob.

The still image is deleted. When the operation is finished, the message "COMPLETE" appears.

4. Press the [MENU] button to close the menu.

## Saving a Still Image to a USB Flash Drive

Here's how a still image captured from the input/output video (p. 23) can be saved to a USB flash drive.

\* You can't export still images that were created while HDCP (p. 15) was set to "ON."

**NOTE**

- When using a USB flash drive for the first time, you must format it using the V-160HD (p. 64).
- Never turn off the power or remove the USB flash drive while the message "PLEASE WAIT" is shown.
- Depending on the USB flash drive, recognition of the flash drive might take some time.

1. Connect the USB flash drive to the USB MEMORY port.

2. [MENU] button → "STILL IMAGE" → "SAVE TO USB MEMORY," and press the [VALUE] knob.

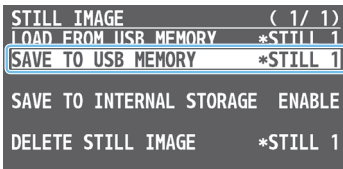

A "\*" symbol is displayed for memory where a still image is already saved.

3. Use the [VALUE] knob to select the memory (STILL 1–16) for the still image that you want to save.

A list of the still images in the USB flash drive is shown.

4. Use the [VALUE] knob to select "NEW FILE...," and press the [VALUE] knob.

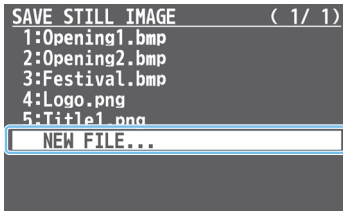

5. Select the file format.

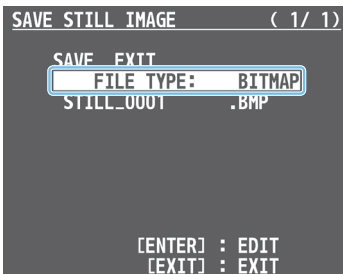

- 1 Use the [VALUE] knob to select "FILE TYPE," and press the [VALUE] knob.
- 2 Use the [VALUE] knob to select "BITMAP," "PNG," or "JPEG," and press the [VALUE] knob.

6. Enter a file name.

\* You can input up to 16 characters.

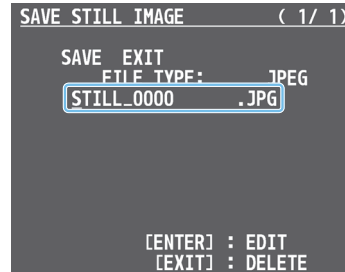

- 1 Use the [VALUE] knob to move the cursor. Pressing the [EXIT] button deletes the character at the cursor location.
- 2 Press the [VALUE] knob to highlight the character at the cursor location.
- 3 Use the [VALUE] knob to change the character, and press the [VALUE] knob.

7. When you finish entering the name, use the [VALUE] knob to select "SAVE," and press the [VALUE] knob.

A confirmation message appears.

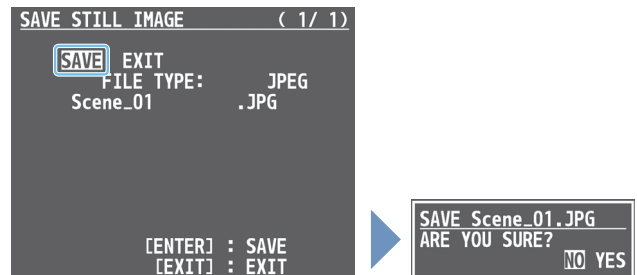

\* If you decide to cancel, press the [EXIT] button.

8. Use the [VALUE] knob to select "YES," and press the [VALUE] knob.

The still image is written to the USB flash drive.

9. Press the [MENU] button to close the menu.

**MEMO**

**Overwriting a still image**

You can overwrite a still image by selecting an existing still image file in step 4 and pressing the [VALUE] knob.

**Editing the filename and saving the image**

When you select an existing still image file in step 4 and long-press the [VALUE] knob, the edit screen appears. Edit the filename and file format as necessary to save it as a different file or in a different format.



## Outputting a Loaded Still Image

You can assign a still image to the cross-point [1]–[10] buttons and output it in the same way as with video, or momentarily stop the final output to output the still image.

\* When outputting a still image (.png) with an alpha channel, the alpha channel (transparency) data is ignored.

## Assigning a Still Image to the Cross-point Buttons

A still image loaded into this unit can be assigned to the cross-point [1]–[10] buttons, and output in the same way as video.

1. Load a still image into this unit as described by the following procedures.
  - ➔ “Loading a Still Image from a USB Flash Drive” (p. 22)
  - ➔ “Capturing a Still Image from Input/Output Video” (p. 23)
2. Assign the still image to a cross-point button by following the steps in “Assigning Video Sources” (p. 13).
3. Follow the steps in “Switching the Video” (p. 17) to output the still image.

## Inserting a Still Image in the Final Output

You can pause the final output, and output a still image of your choice as a cut.

Still images can be directly output without being assigned to the cross-point [1]–[10] buttons.

\* The same still image as the final output is also output to the preview.

Use the following methods to output still images.

### Using the USER buttons

➔ “Assigning Functions to the USER Buttons” (p. 65)

### Using a footswitch

➔ “Using a Footswitch” (p. 68)

### Using an expression pedal

➔ “Using an Expression Pedal” (p. 69)

### Inputting an external control signal (GPI)

➔ “Inputting a Control Signal” (p. 70)

#### MEMO

#### Outputting a still image with a fade-in effect

Use the [OUTPUT FADE] button to add a fade-in effect and output the still image.

Assign a still image to the AUX bus (p. 15) and edit the function for the [OUTPUT FADE] button as shown below.

Use the [MENU] button → “SYSTEM” → and set OUTPUT FADE ASSIGN “VIDEO FADE” to “AUX.”

## Freezing the Input Video (Freeze)

Here’s how to temporarily freeze the input video (freeze function).

You can apply transition effects during a video freeze.

## Setting the Operation mode

There are two freeze modes: the “ALL mode” for freezing all input video, and the “SELECT mode” that freezes only the input video you specify. Set the mode that matches your needs.

1. [MENU] button → “FREEZE” → select “TYPE,” and press the [VALUE] knob.



2. Use the [VALUE] knob to select “ALL” or “SELECT,” and press the [VALUE] knob.

Value	Explanation
ALL	Freezes all video that is being input.
SELECT	Freezes only the specified input video.

#### If “SELECT” is selected

3. Use the [VALUE] knob to select “INPUT 1”–“INPUT 10,” and press the [VALUE] knob.
4. Use the [VALUE] knob to select “ENABLE” or “DISABLE,” and press the [VALUE] knob.

Value	Explanation
ENABLE	The input video freezes.
DISABLE	The input video does not freeze.

5. Press the [MENU] button to close the menu.

## Freezing the Input Video

1. [MENU] button → “FREEZE” → select “FREEZE,” and press the [VALUE] knob.



2. Use the [VALUE] knob to select “ON,” and press the [VALUE] knob.

The freeze function turns on, and the input video freezes.

3. Press the [MENU] button to close the menu.

#### MEMO

You can assign the freeze function to a USER button and turn it on/off (p. 65).

With the factory settings, the USER [1] button is assigned the freeze function.

## Fading-In/Out the Final Output Video

Here's how to perform a fade-out from the final output video to a black screen, or a fade-in from a black screen to the final output video. A scene that you don't want to output as video can be changed to a black screen.

- \* The final output video and audio fades in/out together when using the factory default settings.
- \* The fade-in/out effect is applied only to the final output.

### 1. Press the [OUTPUT FADE] button.

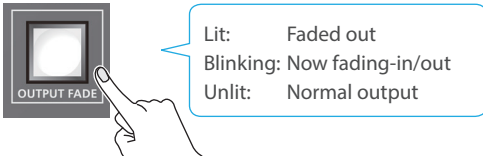

The final output video fades-out to a black screen. When fade-out is complete, the [OUTPUT FADE] button is lit.

### 2. To fade-in, press the [OUTPUT FADE] button once again.

The [OUTPUT FADE] button blinks, and final output begins. When fade-in is complete, the [OUTPUT FADE] button goes dark.

#### MEMO

- You can use a white screen or the video from the AUX bus to add a fade-in/out effect.  
To make this setting, use the [MENU] button → "SYSTEM" → OUTPUT FADE ASSIGN "VIDEO FADE."
- To create a fade-in/out effect for the video without changing the volume, set "AUDIO FADE" in "OUTPUT FADE ASSIGN" from the [MENU] button → "SYSTEM" to "DISABLE."
- To specify fade-in/out time, use the [MENU] button → "TRANSITION TIME" → "MIX/WIPE TIME."

# Video Composition Operations

## Compositing Video with Split

Here's how to composite two videos in dividing the screen into left/right or upper/lower.

### Positioning a video

Left or upper: Video on the PGM/A bus

Right or lower: Video on the PST/B bus



## Configuring the Screen Layout

You can configure the screen layout separately for the [SPLIT 1] and [SPLIT 2] buttons.

1. [MENU] button → "SPLIT" → "SPLIT 1" or "SPLIT 2" → select "SPLIT TYPE," and press the [VALUE] knob.

SPLIT 1	( 1 / 1 )
SPLIT	OFF
SPLIT TYPE	SPLIT V
PGM/A-CENTER	0.0%
PST/B-CENTER	0.0%
CENTER POSITION	0.0%
BORDER COLOR	WHITE
BORDER WIDTH	3

2. Use the [VALUE] knob to select "SPLIT V" or "SPLIT H," and press the [VALUE] knob.

Value	Explanation
SPLIT V	This vertically crops the center section of the video (split left/right). 
SPLIT H	This horizontally crops the center section of the video (split upper/lower). 

3. Press the [MENU] button to quit the menu.

### MEMO

You can change the color and width of the boundary.

To make this setting, use the [MENU] button → "SPLIT" → "SPLIT 1" or "SPLIT 2" → "BORDER COLOR" and "BORDER WIDTH."

## Compositing Using SPLIT

1. Press a PGM/A cross-point [1]–[10] button to select the video you want to display upper or on the left.

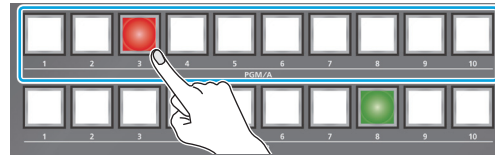

2. Press a PST/B cross-point [1]–[10] button to select the video you want to display lower or on the right.

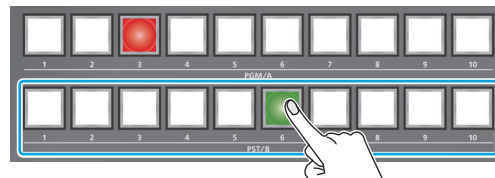

3. Press the [SPLIT 1] or [SPLIT 2] button to turn on split compositing (lit).

The video you selected in steps 1 and 2 is composited.

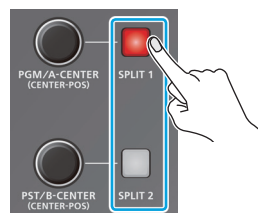

4. Use the [PGM/A-CENTER] and [PST/B-CENTER] knob to adjust the position of the video or boundary.

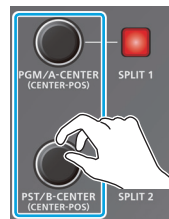

Knob	Explanation
[PGM/A-CENTER]	Adjusts the horizontal/vertical position of the video that's shown in the left or upper area. <b>Turn while pressing:</b> Adjusts the position of the boundary.
[PST/B-CENTER]	Adjusts the horizontal/vertical position of the video that's shown in the right or lower area. <b>Turn while pressing:</b> Adjusts the position of the boundary.

5. To turn off split compositing, press the [SPLIT 1] or [SPLIT 2] button once again.

# Compositing Video with Picture-in-Picture (PinP)

Here's how to composite an inset screen onto the background video. You can use PinP & KEY 1–4 at the same time to display four inset screens. This example shows you how to composite video using "PinP & KEY 1." The operation is the same when using "PinP & KEY 2–4."

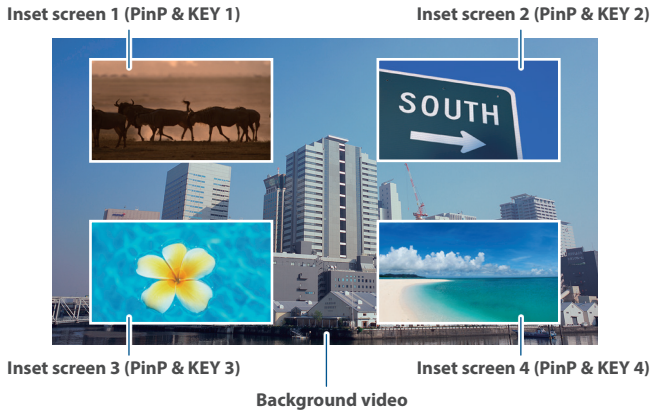

1. Press the PinP & KEY 1 [SOURCE] button to turn it on (the button lights up).

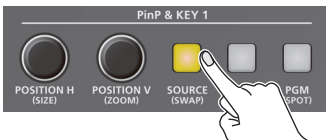

2. Press a PinP & KEY SOURCE [1]–[10] button to select the video you want to make the inset screen.

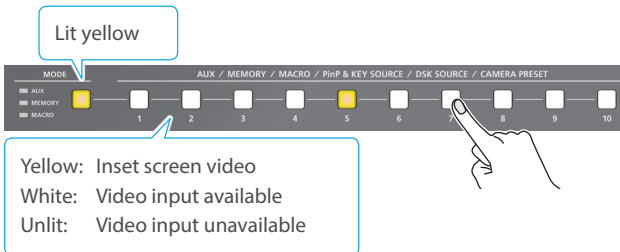

\* When selecting a video not assigned to INPUT 1–10, set this from the [MENU] button → "PinP & KEY" → "PinP & KEY 1" → "PinP SOURCE."

3. Press the PinP & KEY 1 [PVW] button to turn on the inset screen preview output (lit).

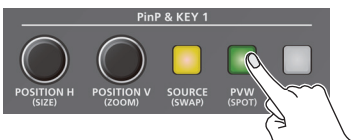

The inset screen appears in the PVW section of the multi-view, allowing you to check the inset screen's location and size. At this stage, the final output has not yet been changed.

4. Use the PinP & KEY 1 [POSITION H] [POSITION V] knobs to adjust the inset screen.

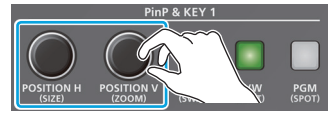

Knob	Explanation
[POSITION H]	Adjusts the horizontal position of the inset screen. <b>Turn while pressing:</b> Adjusts the size of the inset screen.
[POSITION V]	Adjusts the vertical position of the inset screen. <b>Turn while pressing:</b> Adjusts the zoom of the video shown in the inset screen.

5. Press the PinP & KEY 1 [PGM] button to turn on PinP compositing (lit).

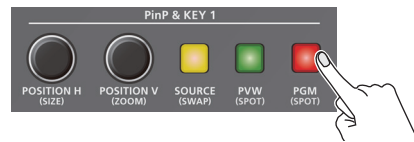

The inset screen is displayed on the final output.

6. To turn off PinP compositing, press the PinP & KEY 1 [PGM] button once again.

## Turning PinP/DSK composition on/off in tandem with video transitions

You can make PinP/DSK composition (p. 30) turn on/off in tandem with the video transitions.

From the [MENU] button → "SYSTEM," set "EFFECTS TRANSITION SYNC" to "ON."

After step 4, use the [AUTO] and [CUT] buttons or operate the video fader to switch the video. PinP composition turns on, and the composited result that is previewed is sent to final output.

### MEMO

- The output video layers are structured as shown in the illustration below.

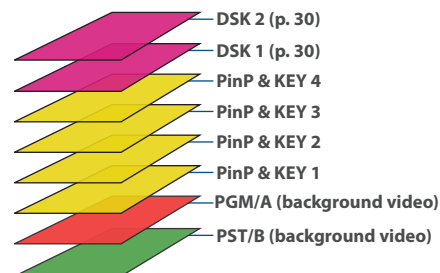

Long-pressing the [PVW] or [PGM] button for each layer shows only the layer that is targeted for the operation while the button is pressed (this is the spot function).

- Set the fade-in/out time for the inset screen from the [MENU] button → "TRANSITION TIME" → "PinP & KEY 1–4 TIME."

## Making Detailed Settings for the Inset Screen

Detailed settings for size, shape, and border width etc. can be made for the inset screens.

1. [MENU] button → “PinP & KEY” → “PinP & KEY 1”– “PinP & KEY 4,” and press the [VALUE] knob.

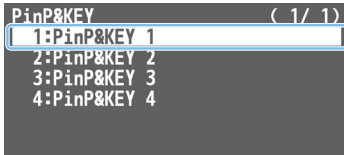

2. Use the [VALUE] knob to select a menu item shown below, and press the [VALUE] knob.

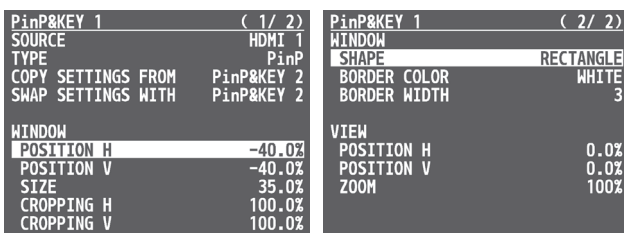

Menu item	Explanation
WINDOW	Adjusts the inset screen.
POSITION H	Adjusts the horizontal position.
POSITION V	Adjusts the vertical position.
SIZE	Adjusts the size.
CROPPING H	Adjusts the horizontal size.
CROPPING V	Adjusts the vertical size.
SHAPE	Specifies the shape (rectangle, circle, diamond).
BORDER COLOR	Specifies the color of the border.
BORDER WIDTH	Adjusts the width of the border.
VIEW	Adjusts the video that is shown in the inset screen.
POSITION H	Adjusts the horizontal position.
POSITION V	Adjusts the vertical position.
ZOOM	Adjusts the zoom of the video.

3. Use the [VALUE] knob to change the value of the setting.
4. Press the [MENU] button to quit the menu.

### MEMO

#### Swapping the settings

You can change the stacking order of the inset screens by swapping the settings of the other PinP and key layers.

1. Hold down the PinP & KEY [SOURCE] button of the swap source layer to make it light up.
2. Press a PinP & KEY [SOURCE] button that is blinking to select the swap destination.  
This swaps the settings of the layers.

#### Copying settings

You can copy settings from other PinP and key layers.

From “COPY SETTINGS FROM” in the PinP & KEY 1–4 menu, select the copy source and press the [VALUE] knob to execute.

## Key Compositing the Inset Screen

This process makes part of the inset screen transparent, and composites the image with the background video.

You can use luminance key with either a black or a white background, or a chroma key with either a blue or green background.

### Luminance key

You can cut out text or an image by turning its black or white portion transparent, and then superimpose it on the background video.

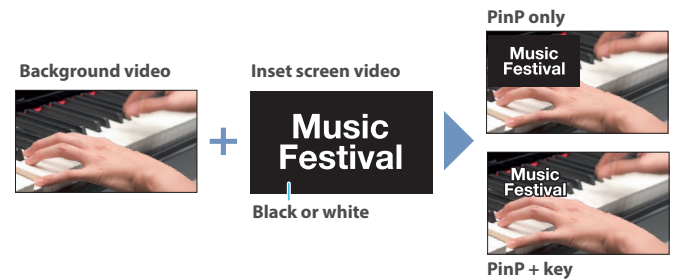

### Chroma key

You can cut out a video by turning its blue or green portion transparent, and then superimpose it on the background video.

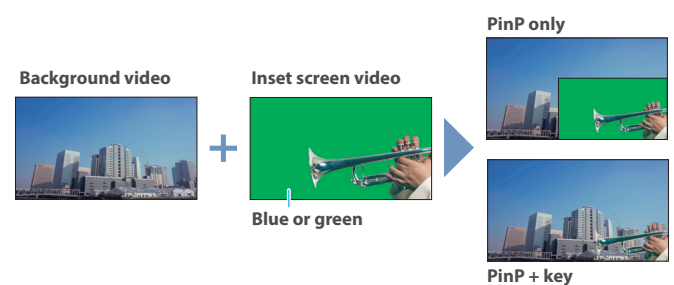

1. [MENU] button → “PinP & KEY” → “PinP & KEY 1”– “PinP & KEY 4” → select “TYPE,” and press the [VALUE] knob.

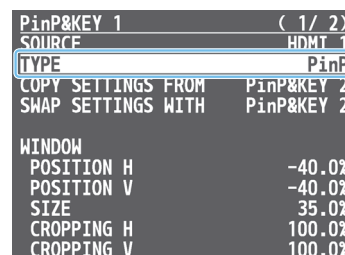

2. Use the [VALUE] knob to select the type of PinP compositing, and press the [VALUE] knob.

Menu item	Explanation
LUMINANCE-WHITE KEY	A combination of PinP and luminance key (white). Makes the white portions of the inset screen transparent, and composites the image with the background.
LUMINANCE-BLACK KEY	A combination of PinP and luminance key (black). Makes the black portions of the inset screen transparent, and composites the image with the background.
CHROMA KEY	A combination of PinP and chroma key. Makes the specified key color portions of the inset screen transparent, and composites the image with the background.

3. Select the menu item and adjust the intensity of the effect.

\* For details on the menu items, refer to “7: PinP & KEY” (p. 79).

4. Press the [MENU] button to quit the menu.

## Compositing Video with Downstream Keyer (DSK)

You can further composite titles, subtitles/captions and other video on video composited using split (p. 27) or PinP (p. 28). There are two DSK series on the V-160HD. DSK layers are shown in front of other layers (➡ memo on p. 28).

### About DSK Mode

There are three DSK composition modes, "self key," "alpha key" and "external key." The following video compositing is available according to the DSK mode.

#### Self key

##### Luminance key (p. 31)

You can cut out text or an image by turning its black or white portion transparent, and then superimpose it on the background video



##### Chroma key (p. 33)

You can cut out a video by turning its blue or green portion transparent, and then superimpose it on the background video. You can select a color from the video material to set as the key color.



#### Alpha key (p. 35)

Use alpha channels (areas which contain transparency data) to cut out still images and place them against different background video as a composite.



#### External key (p. 36)

Sets the key signal (the shape to be cut out) and the fill video (the video to be composited) separately. This uses the key signal to cut out the fill video and superimpose it on the background video to create the composite.

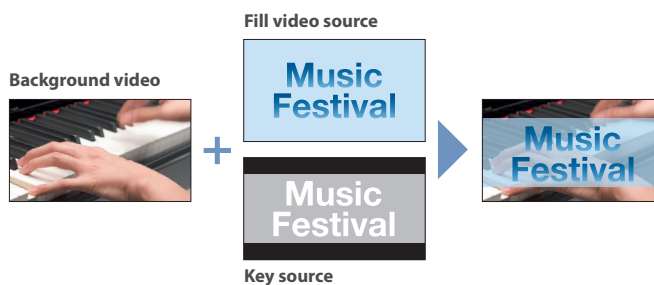

## Compositing a Caption or Image (Luminance Key)

Here's how you can cut out text or image by turning its black or white portion transparent, and then superimpose it on the background video.



### Setting the DSK mode and DSK type

1. [MENU] button → "DSK" → "DSK 1" or "DSK 2" → select "DSK MODE" or "DSK TYPE," and press the [VALUE] knob.

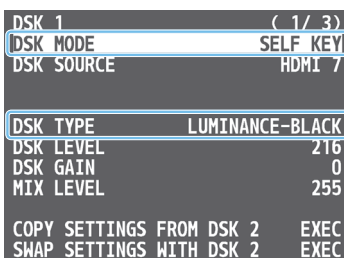

2. Use the [VALUE] knob to change the setting as shown below.

Menu item	Setting
DSK MODE	SELF KEY
DSK TYPE	LUMINANCE-WHITE (Makes white portions transparent according to brightness.)
	LUMINANCE-BLACK (Makes black portions transparent according to brightness.)

3. Press the [MENU] button to quit the menu.

### Compositing using DSK

Here we explain how to use "DSK 1" for compositing images. The operation is the same when using "DSK 2."

1. Press the DSK 1 [SOURCE] button to turn it on (the button lights up).

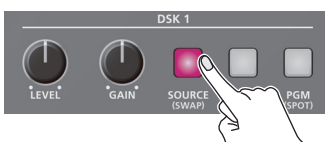

2. Press a DSK SOURCE [1]–[10] button to select the DSK video source.

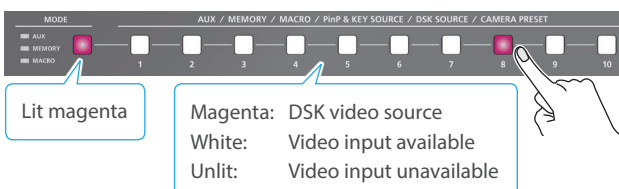

\* When selecting a video not assigned to INPUT 1–10, set this from the [MENU] button → "DSK" → "DSK 1" → "DSK SOURCE."

3. Press the DSK 1 [PVW] button to turn on the preview output (lit).



A preview of the composition results is displayed in the PVW section of the multi-view.

At this stage, the final output has not yet been changed.

4. Use the DSK 1 [LEVEL] and [GAIN] knob to adjust the degree of effect applied.



Knob	Explanation
[LEVEL]	Adjusts the degree of extraction (transparency) for the key.
[GAIN]	Adjusts the degree of edge blur (semi-transmissive region) for the key.

5. Press the DSK 1 [PGM] button to turn on DSK compositing (lit).

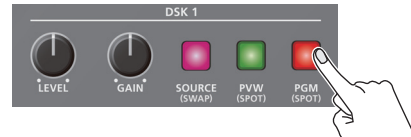

The composition results is sent to final output.

6. To turn off DSK compositing, press the DSK 1 [PGM] button once again.

#### MEMO

Set the fade-in/out time for the DSK video to superimpose from the [MENU] button → "TRANSITION TIME" → "DSK 1 TIME" or "DSK 2 TIME."

### Turning DSK/PinP composition on/off in tandem with video transitions

---

You can make DSK/PinP composition (p. 28) turn on/off in tandem with the video transitions.

From the [MENU] button → “SYSTEM,” set “EFFECTS TRANSITION SYNC” to “ON.”

After step 4, use the [AUTO] and [CUT] buttons or operate the video fader to switch the video. DSK composition turns on, and the composited result that is previewed is sent to final output.

### Modifying the caption or image

---

You can fill-in the superimposed caption or image, or add an edge to it.

Use the [MENU] button → “DSK” → “DSK 1” or “DSK 2” to make the settings for the following menu items.

Menu item	Explanation
FILL TYPE	If this is set to “MATTE,” the superimposed caption or video is filled in with the color specified in “MATTE COLOR.”
MATTE COLOR	
EDGE TYPE	Specifies the type of edge.
EDGE COLOR	Specifies the color of the edge.
EDGE WIDTH	Specifies the width of the edge.

\* This setting is in common with chroma key (p. 33).



## Compositing a Subject and Background (Chroma Key)

Here's how you can cut out a video by turning its blue or green portion transparent, and then superimpose it on the background video. This lets you composite a subject that's photographed against a blue background or green background.



### Setting the DSK mode and DSK type

1. [MENU] button → "DSK" → "DSK 1" or "DSK 2" → select "DSK MODE," "DSK TYPE," or "COLOR," and press the [VALUE] knob.

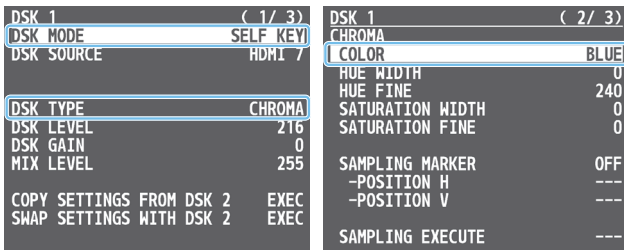

2. Use the [VALUE] knob to change the setting as shown below.

Menu item	Setting
DSK MODE	SELF KEY
DSK TYPE	CHROMA
COLOR	Specify either "GREEN" or "BLUE" as the key color. You can also specify a color you desire as the key color (p. 34).

3. Press the [MENU] button to quit the menu.

### Compositing using DSK

Here we explain how to use "DSK 1" for compositing videos. The operation is the same when using "DSK 2."

1. Press the DSK 1 [SOURCE] button to turn it on (the button lights up).



2. Press a DSK SOURCE [1]–[10] button to select the DSK video source.

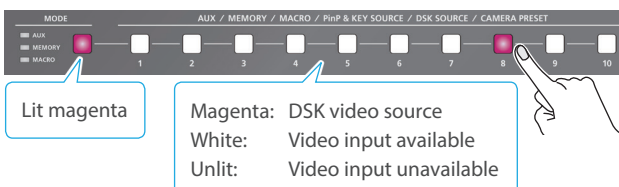

\* When selecting a video not assigned to INPUT 1–10, set this from the [MENU] button → "DSK" → "DSK 1" → "DSK SOURCE."

3. Press the DSK 1 [PVW] button to turn on the preview output (lit).



A preview of the composition results is displayed in the PVW section of the multi-view.

At this stage, the final output has not yet been changed.

4. Use the DSK 1 [LEVEL] and [GAIN] knob to adjust the degree of effect applied.



Knob	Explanation
[LEVEL]	Adjusts the degree of extraction (transparency) for the key.
[GAIN]	Adjusts the degree of edge blur (semi-transmissive region) for the key.

5. Press the DSK 1 [PGM] button to turn on DSK compositing (lit).

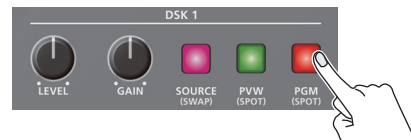

The composition results is sent to final output.

6. To turn off DSK compositing, press the DSK 1 [PGM] button once again.

#### MEMO

Set the fade-in/out time for the DSK video to superimpose from the [MENU] button → "TRANSITION TIME" → "DSK 1 TIME" or "DSK 2 TIME."

### Turning DSK/PinP composition on/off in tandem with video transitions

You can make DSK/PinP composition (p. 28) turn on/off in tandem with the video transitions.

From the [MENU] button → "SYSTEM," set "EFFECTS TRANSITION SYNC" to "ON."

After step 4, use the [AUTO] and [CUT] buttons or operate the video fader to switch the video. DSK composition turns on, and the composited result that is previewed is sent to final output.

## Finely adjusting the key color

You can make fine adjustments to the key color.

Use the [MENU] button → “DSK” → “DSK 1” or “DSK 2” to make the settings for the following menu items.

Menu item	Explanation
<b>CHROMA</b>	
HUE WIDTH	Adjusts the hue width.
HUE FINE	Adjusts the center position of the hue.
SATURATION WIDTH	Adjusts the saturation width.
SATURATION FINE	Adjusts the center position of saturation.

## Modifying the superimposed video

You can fill-in the superimposed video, or add an edge to it.

Use the [MENU] button → “DSK” → “DSK 1” or “DSK 2” to make the settings for the following menu items.

Menu item	Explanation
FILL TYPE	If this is set to “MATTE,” the superimposed video is filled in with the color specified in “MATTE COLOR.”
MATTE COLOR	
EDGE TYPE	Specifies the type of edge.
EDGE COLOR	Specifies the color of the edge.
EDGE WIDTH	Specifies the width of the edge.

\* This setting is in common with luminance key (p. 31).

## Specifying a desired color as the key color (sampling marker)

You can specify the key color to be made transparent by sampling (detecting) a color from the video (sampling marker function).

You can also specify a key color other than green or blue.

1. [MENU] button → “DSK” → “DSK 1” or “DSK 2” → select “SAMPLING MARKER,” and press the [VALUE] knob.

DSK 1 ( 2 / 3 )	
CHROMA	
COLOR	BLUE
HUE WIDTH	0
HUE FINE	240
SATURATION WIDTH	0
SATURATION FINE	0
SAMPLING MARKER	OFF
-POSITION H	---
-POSITION V	---
SAMPLING EXECUTE	---

2. Use the [VALUE] knob to select “ON,” and press the [VALUE] knob.

The sampling marker (  ) used to sample (detect) the key color is shown on the monitor of this unit and in the HDMI OUT 3 connector’s output video.

3. Use the [VALUE] knob to select “POSITION H” or “POSITION V;” and press the [VALUE] knob.

4. Use the [VALUE] knob to adjust the position of the sampling marker.

Menu item	Explanation
POSITION H	Adjusts the horizontal position.
POSITION V	Adjusts the vertical position.

5. Use the [VALUE] knob to select “SAMPLING EXECUTE,” and press the [VALUE] knob.

A confirmation message appears.

DSK 1 ( 2 / 3 )	
CHROMA	
COLOR	BLUE
HUE WIDTH	0
HUE FINE	240
SATURATION WIDTH	0
SATURATION FINE	0
SAMPLING MARKER	ON
-POSITION H	30%
-POSITION V	-24%
SAMPLING EXECUTE	EXEC

CHROMA SAMPLING  
 ARE YOU SURE?  
 NO YES

\* If you decide to cancel, press the [EXIT] button.

6. Use the [VALUE] knob to select “YES,” and press the [VALUE] knob.

The key color is sampled.

The “HUE WIDTH,” “HUE FINE,” “SATURATION WIDTH,” and “SATURATION FINE” settings are adjusted automatically.

7. Press the [MENU] button to quit the menu.

## Compositing a Still Image with Alpha Channel

Use alpha channels (areas which contain transparency data) to cut out still images and place them against different background video as a composite.



### Setting the DSK mode or a still image to composite

1. [MENU] button → "DSK" → "DSK 1" or "DSK 2" → select "DSK MODE" or "DSK SOURCE," and press the [VALUE] knob.

DSK 1	( 1 / 1 )
DSK MODE	ALPHA KEY
DSK SOURCE	STILL 1
DSK TYPE	---
DSK LEVEL	---
DSK GAIN	---
MIX LEVEL	255
COPY SETTINGS FROM DSK 2	EXEC
SWAP SETTINGS WITH DSK 2	EXEC

2. Use the [VALUE] knob to change the setting as shown below.

Menu item	Setting
DSK MODE	ALPHA KEY
DSK SOURCE	Specifies the still image with alpha channel.

3. Press the [MENU] button to quit the menu.

#### MEMO

You can also select the still images assigned to INPUT 1–10 as a DSK video source with the buttons.

Press the DSK 1 or DSK 2 [SOURCE] button to turn it on (the button lights), and then select using the DSK SOURCE [1]–[10] buttons.

### Compositing using DSK

In this example, we explain how to composite a still image using "DSK 1." The operation is the same when using "DSK 2."

1. Press the DSK 1 [SOURCE] button to turn it on (the button lights up).

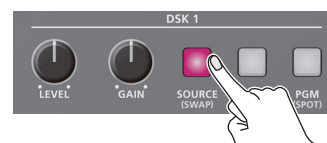

2. Press the DSK 1 [PVW] button to turn on the preview output (lit).



A preview of the composition results is displayed in the PVW section of the multi-view.

At this stage, the final output has not yet been changed.

3. Press the DSK 1 [PGM] button to turn on DSK compositing (lit).

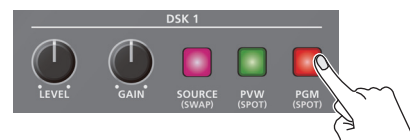

The composition results is sent to final output.

4. To turn off DSK compositing, press the DSK 1 [PGM] button once again.

#### MEMO

Set the fade-in/out time for the still image to superimpose from the [MENU] button → "TRANSITION TIME" → "DSK 1 TIME" or "DSK 2 TIME."

### Turning DSK/PinP composition on/off in tandem with video transitions

You can make DSK/PinP composition (p. 28) turn on/off in tandem with the video transitions.

From the [MENU] button → "SYSTEM," set "EFFECTS TRANSITION SYNC" to "ON."

After step 2, use the [AUTO] and [CUT] buttons or operate the video fader to switch the video. DSK composition turns on, and the composited result that is previewed is sent to final output.

## Using an External Key

This sets the key signal (the shape to be cut out) and the fill video (the video to be composited) separately. With an external key, the key signal is used to cut out the fill video and superimpose it on the background video to create the composite.

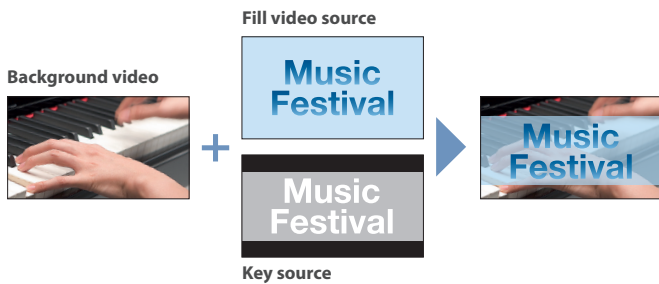

## Setting the DSK mode or key/fill video

1. [MENU] button → “DSK” → “DSK 1” or “DSK 2” → select “DSK MODE,” “KEY SOURCE,” or “FILL SOURCE,” and press the [VALUE] knob.

DSK 1 ( 1 / 1 )	
DSK MODE	EXTERNAL KEY
KEY SOURCE	HDMI 7
FILL SOURCE	HDMI 7
DSK TYPE	---
DSK LEVEL	---
DSK GAIN	---
MIX LEVEL	255
COPY SETTINGS FROM DSK 2	EXEC
SWAP SETTINGS WITH DSK 2	EXEC

2. Use the [VALUE] knob to change the setting as shown below.

Menu item	Setting
DSK MODE	EXTERNAL KEY
KEY SOURCE	Specifies the video to use as the key signal.
FILL SOURCE	Specifies the fill video source.

3. Press the [MENU] button to quit the menu.

### MEMO

You can also use the buttons to select the videos assigned to INPUT 1–10 as a fill video source. Press the DSK 1 or DSK 2 [SOURCE] button to turn it on (the button lights), and then select using the DSK SOURCE [1]–[10] buttons.

## Compositing using DSK

Here we explain how to use “DSK 1” for compositing videos. The operation is the same when using “DSK 2.”

1. Press the DSK 1 [SOURCE] button to turn it on (the button lights up).



2. Press the DSK 1 [PVW] button to turn on the preview output (lit).



A preview of the composition results is displayed in the PVW section of the multi-view.

At this stage, the final output has not yet been changed.

3. Press the DSK 1 [PGM] button to turn on DSK compositing (lit).

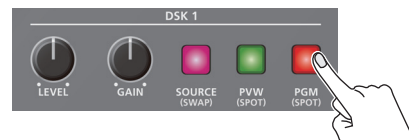

The composition results is sent to final output.

4. To turn off DSK compositing, press the DSK 1 [PGM] button once again.

### MEMO

Set the fade-in/out time for the DSK video to superimpose from the [MENU] button → “TRANSITION TIME” → “DSK 1 TIME” or “DSK 2 TIME.”

## Turning DSK/PinP composition on/off in tandem with video transitions

You can make DSK/PinP composition (p. 28) turn on/off in tandem with the video transitions.

From the [MENU] button → “SYSTEM,” set “EFFECTS TRANSITION SYNC” to “ON.”

After step 2, use the [AUTO] and [CUT] buttons or operate the video fader to switch the video. DSK composition turns on, and the composited result that is previewed is sent to final output.

# Audio Operations

## Adjusting the Input Gain (Sensitivity)

Here's how to adjust the input gain so that the AUDIO IN 1 or 2 audio is at the appropriate level.

1. Move the AUDIO INPUT LEVEL [1] or [2] knob to a position near "0dB."



2. Move the [MASTER OUTPUT] knob to a position near "0 dB."



3. [MENU] button → "AUDIO INPUT" → "AUDIO IN 1" or "AUDIO IN 2" → "ANALOG GAIN," and press the [VALUE] knob.

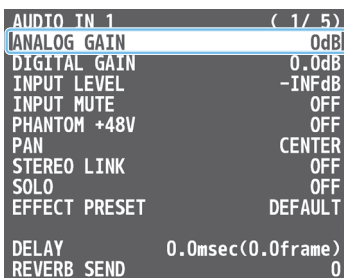

4. Turn the [VALUE] knob fully counter-clockwise, minimizing (0dB) the input gain.
5. While producing the sound that will actually be input, slowly turn the [VALUE] knob clockwise to adjust the input gain.

Raise the input gain as high as possible without allowing the SIG/PEAK indicator of AUDIO INPUT LEVEL 1 or 2 to light red when the loudest sound level occurs.



6. Press the [MENU] button to close the menu.

### MEMO

#### Stereo link function

You can link AUDIO IN 1 and 2 to operate them as a stereo channel.

Use the [MENU] button → "AUDIO INPUT" → "AUDIO IN 1" or "AUDIO IN 2" → set "STEREO LINK" to "ON."

\* When stereo link is turned on, the settings of AUDIO IN 1 are applied to AUDIO IN 2.

\* When stereo link is on, the AUDIO INPUT LEVEL [2] knob is disabled.

\* When phantom power is on and you switch the stereo link setting on/off, phantom power automatically turns off.

#### Adjusting the mic position (pan)

The left/right positioning of the sound is called "pan." If you're using two mics to stream a performance, panning the two mics to left and right will give the sound a more spacious feel.

To make adjustments, use the [MENU] button → "AUDIO INPUT" → "AUDIO IN 1" or "AUDIO IN 2" → "PAN."

#### SIG/PEAK indicator

Indicator	Status
Red	Volume is excessive (0 dB or higher)
Yellow	Volume is appropriate (-20 -- -1 dB).
Green	Volume is insufficient (-50-- -21 dB).

#### Adjusting the digital gain

You can adjust the digital gain for all inputs. Analog gain adjusts the analog sound, and digital gain adjusts the digital sound.

When a high-level audio signal is input to the HDMI or SDI digital audio inputs, distortion may occur due to effect processing.

You can use digital gain to keep the input level down so that there is no impact on effect processing.

## Adjusting the Volume Balance

Here's how to adjust the volume balance of each input and the overall volume.

### 1. Move the [MASTER OUTPUT] knob to a position near "0dB."



### 2. While monitoring the audio via speakers or headphones, adjust the volume balance for the respective inputs.

Raise the volume level of audio you want to make more prominent, for example, an emcee microphone, and lower the volume level for other audio.

When no audio is input, and for audio that is unused, lower the volume level to minimum (-INF dB).

#### AUDIO IN 1-3/4

### ① Use the AUDIO INPUT LEVEL [1] [2] [3/4] knobs to adjust the volume.



#### USB IN, Bluetooth IN, HDMI IN 1-8, SDI IN 1-8

### ① [MENU] button → "AUDIO INPUT" → "USB IN," "Bluetooth IN," "HDMI 1-8," or "SDI 1-8" → select "INPUT LEVEL," and press the [VALUE] knob.

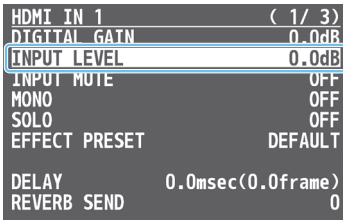

### ② Use the [VALUE] knob to adjust the volume, and press the [VALUE] knob.

### ③ Press the [MENU] button to close the menu.

### 3. Use the [MASTER OUTPUT] knob to adjust the volume of the output.

The level meter will light yellow at the appropriate volume.

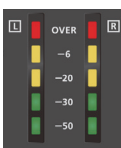

Indicator	Status
Red	Volume is excessive (0 dB or higher)
Yellow	Volume is appropriate (-20 – -1 dB).
Green	Volume is insufficient (-50 – -21 dB).

#### MEMO

- With the factory settings, if you use the [OUTPUT FADE] button to fade-in/out the final output video, the output audio also fades-in/out simultaneously (p. 26).

#### Adjusting the volume of the USB output

The volume of the USB output can be adjusted separately. Use the [USB STREAM] knob to make fine adjustments to the volume of the master output.

If the AUX bus is assigned to the USB STREAM port (p. 45), this fine adjusts the volume of the AUX bus.

- You can output a test tone that is useful when making volume adjustments.

Use the [MENU] button → "SYSTEM" → "TEST TONE" to select the test tone that will be output.

\* The SIG/PEAK indicators for AUX and USB STREAM light up in the same manner.

## Applying Effects to Input Audio

You can apply effects to the input audio to adjust the character of the sound. The following table shows the effects that are available.

Input audio	High-pass filter	Echo canceller	Anti-feedback	Noise gate	De-esser	Compressor	Equalizer	Voice changer	Delay	Reverb
AUDIO IN 1, 2	✓	✓	✓	✓	✓	✓	✓	✓	✓	✓
AUDIO IN 3/4	✓	—	—	✓	—	✓	✓	—	✓	✓
USB IN	✓	—	—	✓	—	✓	✓	—	✓	✓
Bluetooth IN	✓	—	—	✓	—	✓	✓	—	✓	✓
HDMI IN, SDI IN	✓	—	—	✓	—	✓	✓	—	✓	✓

1. [MENU] button → “AUDIO INPUT” → select “AUDIO IN 1”–“SDI IN 8,” and press the [VALUE] knob.

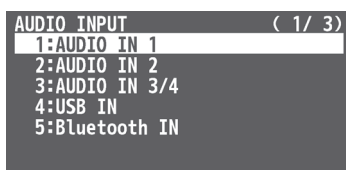

2. Using the [VALUE] knob, select the menu item of the effect you want to use, and press the [VALUE] knob.  
\* For details on the menu items, refer to “9: AUDIO INPUT” (p. 82)
3. Use the [VALUE] knob to change the value of the setting, and press the [VALUE] knob.
4. Press the [MENU] button to close the menu.

### ● High-pass filter

Cuts off unneeded low-band audio. The cutoff frequency is 80 Hz.

### ● Echo canceller (p. 40)

Suppresses the voice echo that can occur when using a web conferencing system that includes a speaker and mic.

### ● Anti-feedback (p. 40)

Suppresses audio feedback.

### ● Noise gate

Eliminates audio that is lower than the specified threshold level. This is effective when the noise that you want to remove is separate from the audio that you want to keep, and can be used to remove hiss or other noise that is heard during periods of silence.

### ● De-esser

Reduces sibilant noise (the sounds you hear when pronouncing “s” words and other hissing sounds).

### ● Compressor

Audio that exceeds the specified threshold level is compressed. This reduces the difference between the maximum volume and minimum volume, making the audio more comfortable for listening.

### ● Equalizer

This is a three-band equalizer. It lets you adjust the volume by boosting or cutting three frequency regions.

### ● Voice changer (p. 41)

Transforms the pitch or character of the voice.

### ● Delay (p. 41)

Outputs audio with a delay.

### ● Reverb (p. 42)

Adds reverberation to the sound.

## Using an Effect Preset

The V-160HD is equipped with effects that are adjusted for specific environments. These are called “effect presets.”

The effect presets are created using a combination of three effects (high-pass filter, compressor, equalizer).

Simply by selecting an effect preset, you can easily apply an effect that’s appropriate for your situation.

### MEMO

- If you want to make fine adjustments to a preset, use the AUDIO INPUT menu to edit the high-pass filter, compressor, and equalizer settings.
- You cannot overwrite the effect presets. Use the preset memories to save the settings for presets you’ve edited (p. 48).
- When you load an effect preset, each preset setting is restored to its default setting (factory defaults).

1. [MENU] button → “AUDIO INPUT” → select “AUDIO IN 1”–“SDI IN 8,” and press the [VALUE] knob.
2. Use the [VALUE] knob to select “EFFECT PRESET,” and press the [VALUE] knob.

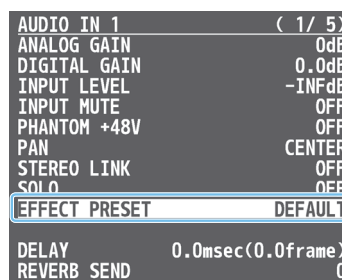

3. Use the [VALUE] knob to select an effect preset, and press the [VALUE] knob.

Value	Explanation
DEFAULT	For line input (default setting)
MEETING	For meetings
INTERVIEW	For interviews
AMBIENT MIC	For capturing ambient sound
WINDY FIELD	For capturing ambient sound in a windy area

A confirmation message appears.

\* If you decide to cancel, press the [EXIT] button.

4. Use the [VALUE] knob to select “OK,” and press the [VALUE] knob.

The effect preset is loaded. When the operation is finished, the message “COMPLETE” appears.

5. Press the [MENU] button to close the menu.

## Suppressing Echo in a Web Conference System (Echo Canceller)

In a conversation using the speaker and mic of a web conference system, an echo can occur when the other person's voice heard through the speaker is picked up by the mic and sent back to the other person.

When you use the echo canceller, the echo component is removed from the voice that is picked up by a mic connected to the V-160HD, so that only your own voice is sent to the other party.

\* This only works on the input audio from the AUDIO IN 1, 2 jacks.

1. [MENU] button → "AUDIO INPUT" → "AUDIO IN 1" or "AUDIO IN 2" → select "ECHO CHANGER," and press the [VALUE] knob.

AUDIO IN 1	( 2 / 5 )
HIGH PASS FILTER 80Hz	OFF
ECHO CANCELLER	OFF
-DEPTH	5
ANTI-FEEDBACK	OFF
NOISE GATE	OFF
-THRESHOLD	-48dB
-RELEASE	500msec

2. Use the [VALUE] knob to select "ON," and press the [VALUE] knob.  
The echo canceller turns on.
3. Use the [VALUE] knob to select "DEPTH," and press the [VALUE] knob.
4. Use the [VALUE] knob to adjust the depth (1–10) of the echo canceller, and press the [VALUE] knob.  
Use the setting that produces the greatest reduction in the echo.
5. Press the [MENU] button to close the menu.

### MEMO

- The echo canceller supports rooms that are approximately 20m<sup>2</sup> (215 sq ft).
- If your own voice returns to you as an echo, you'll need the other party to make echo canceller settings.

## Reducing Acoustic Feedback (Anti-Feedback)

Here's how to reduce the acoustic feedback that can occur when a mic is brought near a speaker.

\* This only works on the input audio from the AUDIO IN 1, 2 jacks.

1. [MENU] button → "AUDIO INPUT" → "AUDIO IN 1" or "AUDIO IN 2" → select "ANTI-FEEDBACK," and press the [VALUE] knob.

AUDIO IN 1	( 2 / 5 )
HIGH PASS FILTER 80Hz	OFF
ECHO CANCELLER	OFF
-DEPTH	5
ANTI-FEEDBACK	OFF
NOISE GATE	OFF
-THRESHOLD	-48dB
-RELEASE	500msec

2. Use the [VALUE] knob to select "ON," and press the [VALUE] knob.  
The anti-feedback turns on.
3. Press the [MENU] button to close the menu.



## Changing the Character of a Voice (Voice Changer)

Here's how to modify the pitch or character of the voice that's input from a mic.

You can create transformations such as "from a female to a male voice," "from a male to a female voice," or "robot voice."

\* This only works on the input audio from the AUDIO IN 1, 2 jacks.

1. [MENU] button → "AUDIO INPUT" → "AUDIO IN 1" or "AUDIO IN 2" → select "VOICE CHANGER," and press the [VALUE] knob.

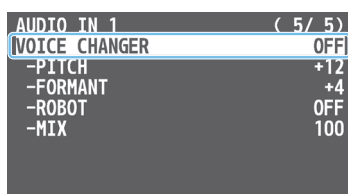

2. Use the [VALUE] knob to select "ON," and press the [VALUE] knob.

The voice changer turns on.

3. Use the [VALUE] knob to select a menu item shown below, and press the [VALUE] knob.

Menu item	Explanation
PITCH	Adjusts the pitch of the voice in semitone steps. A setting of "0" is the original pitch.
FORMANT	Adjusts the character (formant) of the voice. Settings in the negative (-) direction produce a more masculine vocal character, and settings in the positive (+) direction produce a more feminine vocal character. A setting of "0" is the original voice.
ROBOT	When this is "ON," the voice is held at a fixed pitch, creating a mechanical robot-like impression.
MIX	Adjusts the balance between the unprocessed voice (0) and the voice processed by the effect (100).

4. Use the [VALUE] knob to edit the value of the setting, and press the [VALUE] knob.
5. Press the [MENU] button to close the menu.

### MEMO

You can assign the function to a USER button and turn voice changer on/off (p. 65).

## Correcting a Time Difference Between Video and Audio (Delay)

If there is a timing discrepancy between the video and audio, you can correct the output timing by delaying the input audio.

1. [MENU] button → "AUDIO INPUT" → "AUDIO IN 1" – "SDI IN 8" → select "DELAY," and press the [VALUE] knob.

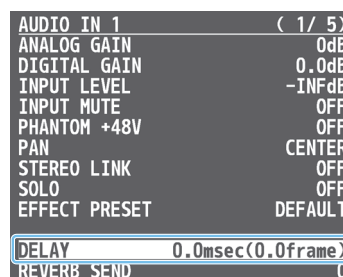

2. Use the [VALUE] knob to adjust the delay time of the input audio.
3. Press the [MENU] button to close the menu.

## Applying Reverb

This adds reverberation to the sound.

\* Reverb is not applied to the audio from the AUX bus.

### Adjusting how much reverb to send

1. [MENU] button → “AUDIO INPUT” → select “AUDIO IN 1”–“SDI IN 8,” and press the [VALUE] knob.
2. Use the [VALUE] knob to select “REVERB SEND,” and press the [VALUE] knob.

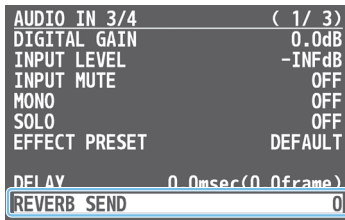

3. Use the [VALUE] knob to adjust the amount of sound that is sent to reverb (reverb depth).
4. Press the [MENU] button to close the menu.

### Adjusting how much reverb is returned

1. [MENU] button → “AUDIO OUTPUT” → “MASTER OUTPUT” → select “REVERB,” and press the [VALUE] knob.

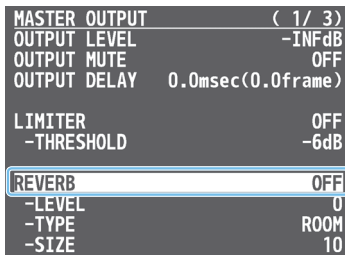

2. Use the [VALUE] knob to select “ON,” and press the [VALUE] knob.  
Reverb turns on.
3. Use the [VALUE] knob to select “LEVEL,” “TYPE,” or “SIZE,” and press the [VALUE] knob.

Menu item	Explanation
LEVEL	Specifies the amount of sound that is returned from the reverb (return level). This adjusts the depth of the overall reverb.
TYPE	Specifies the reverb type. ROOM: Produces the natural-sounding reverberation of a room. HALL: Produces the reverberation that is typical of a performance in a concert hall.
SIZE	Specifies the size of the room. The larger the value, the longer the reverb time.

4. Use the [VALUE] knob to change the value of the setting, and press the [VALUE] knob.
5. Press the [MENU] button to close the menu.

#### MEMO

You can assign the function to a USER button and turn reverb on/off (p. 65).

## Applying Effects to Output Audio

Here’s how to modify the tonal character by applying effects.

The following table shows the effects that are available.

Audio bus	Reverb	Equalizer	Delay	Multi-band compressor	Limiter
MASTER OUTPUT	✓	✓	✓	✓	✓
AUX	—	—	✓	—	✓

1. [MENU] button → “AUDIO OUTPUT” → select “MASTER OUTPUT” or “AUX,” and press the [VALUE] knob.

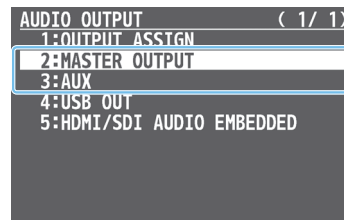

2. Using the [VALUE] knob, select the menu item of the effect you want to use, and press the [VALUE] knob.  
\* For details on the menu items, refer to “10: AUDIO OUTPUT” (p. 88).
3. Use the [VALUE] knob to change the value of the setting, and press the [VALUE] knob.
4. Press the [MENU] button to close the menu.

#### ● Equalizer

This is a three-band equalizer. It lets you adjust the volume by boosting or cutting three frequency regions.

#### ● Delay

Outputs audio with a delay. Delaying the output lets you correct timing problems in the audio signal that is input to the output destination device.

#### ● Multi-band compressor

Applies separate compressors in individual frequency band.

#### ● Limiter

Limits the output volume so that it does not exceed the specified threshold level.

\* Distortion will occur if audio that exceeds the allowable range of the limiter is input.

#### MEMO

##### Adjusting the equalizer/delay for the USB output audio

For USB output, you can also apply equalizer and delay effects to fine-tune the sound assigned to the bus.

Adjust the equalizer and delay parameters from the [MENU] button → “AUDIO OUTPUT” → “USB OUT.”

## Interlinking Audio Output to Video Switching (Audio Follow)

Here's how the audio output can be automatically switched in tandem with video switching (the audio follow function).

1. [MENU] button → select "AUDIO FOLLOW," and press the [VALUE] knob.
2. Use the [VALUE] knob to select the input video that you want to use with Audio Follow, and press the [VALUE] knob.

AUDIO FOLLOW ( 1 / 3 )	
ALL AUDIO FOLLOW	OFF
HDMI IN 1	OFF
HDMI IN 2	OFF
HDMI IN 3	OFF
HDMI IN 4	OFF
HDMI IN 5	OFF
HDMI IN 6	OFF
HDMI IN 7	OFF
HDMI IN 8	OFF

Select "ALL AUDIO FOLLOW" to edit the HDMI IN and SDI IN settings all at once.

3. Use the [VALUE] knob to select "ON," and press the [VALUE] knob.

Value	Explanation
ON	The audio is output only when the video is selected. The audio is automatically muted if another video is selected.
OFF	The audio is always output regardless of the video selection.

4. Press the [MENU] button to close the menu.

## Adding an Object for Audio Follow

You can set Audio Follow to apply to the audio from the AUDIO IN, USB IN or Bluetooth IN.

1. [MENU] button → "AUDIO FOLLOW" → and select the audio input that will be the object of Audio Follow, and press the [VALUE] knob.

AUDIO FOLLOW ( 3 / 3 )	
AUDIO IN 1	OFF
AUDIO IN 2	OFF
AUDIO IN 3/4	OFF
USB IN	OFF
Bluetooth IN	OFF

2. Use the [VALUE] knob to select one of "INPUT 1"–"INPUT 10," and press the [VALUE] knob.

Value	Explanation
INPUT 1–10	For each audio source, these settings specify the input video that will use the audio follow function. Audio is output only when the specified input video is selected.
OFF	The audio is always output regardless of the video selection.

3. Press the [MENU] button to close the menu.

### MEMO

The level meter indicates the audio follow setting. The "A.F" symbol is shown to indicate audio for which audio follow is on.



## Controlling the Volume Automatically (Auto Mixing)

The volume adjustments that would normally be done by the operator can be controlled automatically (auto mixing function).

Since this lets you leave the volume adjustments up to the V-160HD, it can be used in situations where there is no dedicated operator. This is especially useful for meetings, discussions, debates, and other situations where multiple microphones are used.

1. Press the [AUTO MIXING] button to turn the auto mixing function on (lit).



2. [MENU] button → select "AUDIO AUTO MIXING," and press the [VALUE] knob.

The AUDIO AUTO MIXING menu appears.

AUDIO AUTO MIXING ( 1 / 5 )	
AUDIO AUTO MIXING	ON
-AUDIO IN 1	ENABLE
-WEIGHT	100%
-AUDIO IN 2	ENABLE
-WEIGHT	100%
-AUDIO IN 3/4	DISABLE
-WEIGHT	100%
-USB IN	DISABLE
-WEIGHT	100%
-Bluetooth IN	DISABLE
-WEIGHT	100%

3. Specify whether the selected audio is affected or is not affected by auto mixing.

- ① Use the [VALUE] knob to select the audio whose setting you want to specify.
- ② Use the [VALUE] knob to specify whether the selected audio is affected (ENABLE) or is not affected (DISABLE) by auto mixing, and press the [VALUE] knob.  
For audio that does not require auto mixing, such as background music, choose "DISABLE."

4. Specify the priority level for volume-level distribution.

If there is audio that you want to make more prominent, such as when you want to raise the volume level of an emcee microphone, raise the weight level of that audio to emphasize it, and lower the weight level for other audio.

- ① Use the [VALUE] knob to select "WEIGHT," and press the [VALUE] knob.
- ② Use the [VALUE] knob to set the priority level for volume-level distribution (from 0 to 100%), and press the [VALUE] knob.  
When air-conditioner noise or the like is a concern, specify the weight level to a low value.

5. Press the [MENU] button to close the menu.

6. To turn the auto mixing function off, press the [AUTO MIXING] button once again.

## Checking a Specific Audio Input (Solo)

Here's how you can temporarily monitor a specific audio input via the headphones (solo function).

\* The solo function applies to the headphone output. It does not affect output other than the headphones.

1. [MENU] button → "AUDIO INPUT" → "AUDIO IN 1"– "SDI IN 8" → select "SOLO," and press the [VALUE] knob.

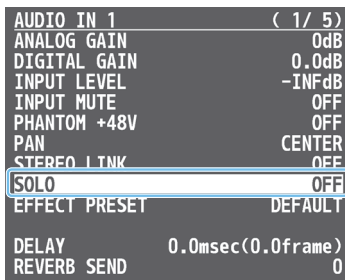

2. Use the [VALUE] knob to select "ON," and press the [VALUE] knob.  
In the headphones, you hear only the audio for which this is on.
3. Press the [MENU] button to close the menu.

## Silencing Only Specific Audio (Mute)

Here's how you can temporarily mute specific audio (the mute function).

### Muting Input Audio

1. [MENU] button → "AUDIO INPUT" → "AUDIO IN 1"– "SDI IN 8" → select "INPUT MUTE," and press the [VALUE] knob.

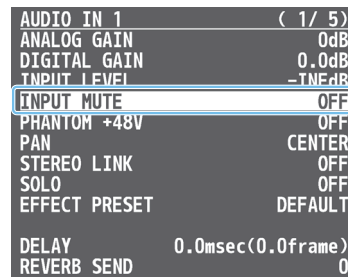

2. Use the [VALUE] knob to select "ON," and press the [VALUE] knob.
3. Press the [MENU] button to close the menu.

### Muting Output Audio

This shows you how to mute the audio from the master output, USB output, and AUX bus.

1. [MENU] button → "AUDIO OUTPUT" → select the menu item shown below, and press the [VALUE] knob.

Master	"MASTER OUTPUT" → "OUTPUT MUTE"
AUX bus	"AUX" → "AUX MUTE"
USB	"USB OUT" → "USB OUT MUTE"

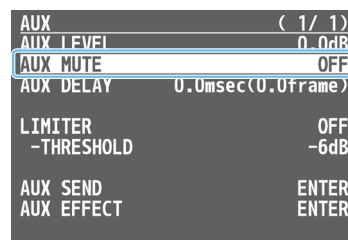

2. Use the [VALUE] knob to select "ON," and press the [VALUE] knob.
3. Press the [MENU] button to close the menu.

#### MEMO

- You can assign the mute function to a USER button and turn it on/off (p. 65).
- The level meter indicates the mute setting. The "MT" symbol is shown to indicate audio for which muting is on.



## Outputting AUX-bus Audio

The V-160HD has two types audio buses: MASTER OUTPUT and AUX. You can assign a desired bus to each output connector.

Audio bus	Explanation
MASTER OUTPUT	All input audio is mixed and output (master output).
AUX	This mixes and outputs only the input audio that is sent to the AUX bus. This allows you to output audio that is different than the master output. For example, in a live event, you might output a mix of all audio inputs, while separately outputting a mix of only specific audio inputs (the AUX bus) for recording or streaming.

## Assigning the AUX Bus

### AUDIO OUT jacks, PHONES jack, USB STREAM port

1. [MENU] button → “AUDIO OUTPUT” → “OUTPUT ASSIGN” → select the output jack, and press the [VALUE] knob.

OUTPUT ASSIGN ( 1 / 1 )	
AUDIO OUT(XLR)	MASTER OUTPUT
AUDIO OUT(RCA)	MASTER OUTPUT
PHONES OUT	MASTER OUTPUT
USB OUT	MASTER OUTPUT
HDMI OUT 1	AUTO
HDMI OUT 2	AUTO
HDMI OUT 3	AUTO
SDI OUT 1	AUTO
SDI OUT 2	AUTO
SDI OUT 3	AUTO

2. Use the [VALUE] knob to select “AUX,” and press the [VALUE] knob.

Value	Explanation
MASTER OUTPUT	Output the audio of the MASTER OUTPUT bus.
AUX	Output the audio of the AUX bus.

3. Press the [MENU] button to close the menu.

### HDMI OUT and SDI OUT connectors

1. [MENU] button → “AUDIO OUTPUT” → “OUTPUT ASSIGN” → select the output connector, and press the [VALUE] knob.

OUTPUT ASSIGN ( 1 / 1 )	
AUDIO OUT(XLR)	MASTER OUTPUT
AUDIO OUT(RCA)	MASTER OUTPUT
PHONES OUT	MASTER OUTPUT
USB OUT	MASTER OUTPUT
HDMI OUT 1	AUTO
HDMI OUT 2	AUTO
HDMI OUT 3	AUTO
SDI OUT 1	AUTO
SDI OUT 2	AUTO
SDI OUT 3	AUTO

2. Use the [VALUE] knob to select “AUX” or “AUTO,” and press the [VALUE] knob.

Value	Explanation						
AUTO	The audio bus automatically switches according to the video bus assignment (p. 14). <table border="1" style="margin-left: 20px;"> <thead> <tr> <th>Video bus</th> <th>Audio bus</th> </tr> </thead> <tbody> <tr> <td>Others besides AUX</td> <td>MASTER OUTPUT</td> </tr> <tr> <td>AUX</td> <td>AUX</td> </tr> </tbody> </table>	Video bus	Audio bus	Others besides AUX	MASTER OUTPUT	AUX	AUX
Video bus	Audio bus						
Others besides AUX	MASTER OUTPUT						
AUX	AUX						
MASTER OUTPUT	Output the audio of the MASTER OUTPUT bus.						
AUX	Output the audio of the AUX bus.						

3. Press the [MENU] button to close the menu.

## Sending Audio to the AUX Bus

\* Use the [AUX] knob to adjust the volume of audio output from the AUX bus.

1. [MENU] button → “AUDIO OUTPUT” → “AUX” → select “AUX SEND,” and press the [VALUE] knob.

The AUX SEND menu appears.

AUX SEND ( 1 / 3 )	
AUX LEVEL	0.0dB
AUX MUTE	OFF
AUX DELAY	0.0msec(0.0frame)
LIMITER	OFF
-THRESHOLD	-6dB
AUX SEND	ENTER
AUX EFFECT	ENTER

2. Use the [VALUE] knob to select the input audio, and press the [VALUE] knob.

\* You can select HDMI IN and SDI IN by setting “AUX SEND VIDEO” to “MANUAL.”

When this is set to “AUTO,” the audio is automatically sent to the AUX bus in tandem with the AUX bus video selection.

3. Use the [VALUE] knob to adjust the amount that is sent to the AUX bus, and press the [VALUE] knob.

4. Press the [MENU] button to close the menu.

## Setting the character of the sound

You can select whether to send either the original audio or the audio processed with effects to the AUX bus.

1. [MENU] button → “AUDIO OUTPUT” → “AUX” → select “AUX EFFECT,” and press the [VALUE] knob.

The AUX EFFECT menu appears.

AUX EFFECT ( 1 / 3 )	
AUDIO IN 1	PRE FADER
AUDIO IN 2	PRE FADER
AUDIO IN 3/4	PRE FADER
USB IN	PRE FADER
Bluetooth IN	PRE FADER

2. Use the [VALUE] knob to select the input audio, and press the [VALUE] knob.

3. Use the [VALUE] knob to select “DRY,” “PRE FADE,” or “POST FADER,” and press the [VALUE] knob.

Value	Explanation
DRY	Sends the source audio with no effects applied.
PRE FADER	Sends the effect-applied audio. The send volume is constant, regardless of the volume (INPUT LEVEL).
POST FADER	Sends the effect-applied audio. The send volume can be changed by adjusting the volume (INPUT LEVEL).

4. Press the [MENU] button to close the menu.

## Adding Input Audio to an HDMI or SDI Video for Output

The HDMI OUT and SDI OUT connectors support 8-channel embedded audio. You can add input audio (sound) to an HDMI or SDI video that is output.

### Assigning HDMI/SDI embedded audio and sound

You can assign the input audio signal you like to channels 3–8 of HDMI or SDI embedded audio.

\* These settings are common for the HDMI OUT 1–3 and SDI OUT 1–3 connectors.

Embedded-audio	Audio
Channel 1	Maser output (L) or AUX bus (L)
Channel 2	Maser output (R) or AUX bus (R)
Channel 3/4	AUDIO IN 1/2
Channel 5/6	AUDIO IN 3/4
Channel 7/8	USB IN, Bluetooth IN

### As a backup for visual or sound recording...

Digital audio is extracted from the HDMI or SDI embedded audio one channel at a time, so after visual recording or sound recording, you can edit the audio channel by channel.

### For multilingual support...

Taking multilingual narration or other such audio, making it embedded audio and adding it to HDMI video or SDI video lets you later extract and use the digital audio for the required language.

1. [MENU] button → “AUDIO OUTPUT” → select “HDMI/SDI AUDIO EMBEDDED,” and press the [VALUE] knob.

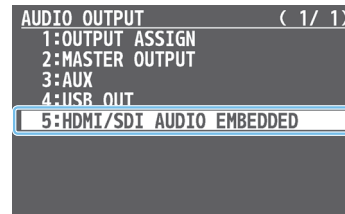

### Assigning the audio

2. Use the [VALUE] knob to select the HDMI or SDI embedded audio channel, and press the [VALUE] knob.

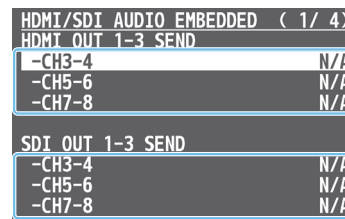

3. Use the [VALUE] knob to select the input audio you wish to assign to the channel, and press the [VALUE] knob.

### Setting the character of the sound

4. Use the [VALUE] knob to select the input audio, and press the [VALUE] knob.

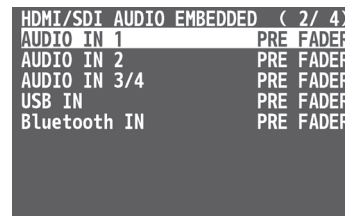

5. Use the [VALUE] knob to select “DRY,” “PRE FADER,” or “POST FADER,” and press the [VALUE] knob.

Value	Explanation
OFF	Audio is not sent.
DRY	Sends the source audio with no effects applied.
PRE FADER	Sends the effect-applied audio. The send volume is constant, regardless of the volume (INPUT LEVEL).
POST FADER	Sends the effect-applied audio. The send volume can be changed by adjusting the volume (INPUT LEVEL).

6. Press the [MENU] button to close the menu.

The audio including channel 3–8 embedded audio is output from the HDMI OUT 1–3 connectors or the SDI OUT 1–3 connectors.

# Live Streaming

## Outputting Video/Audio to a Computer for Streaming

Here's how the video and audio mixed by the V-160HD can be output to a connected computer. You can also input audio that's played back by the computer.

By using an internet-connected computer with streaming app, you can distribute content as a live internet stream.

\* In order for the audio and video from the V-160HD to be correctly viewed on the computer, app that supports the USB video class and USB audio class must be installed on the computer.

\* For the latest operating requirements, refer to the Roland website (<https://proav.roland.com/>).

### Outputting Video and Audio to the Computer

- 1. Using a USB 3.0 cable, connect a USB 3.0 port on the computer to the USB STREAM port on the V-160HD.**
- 2. Turn on the power to the V-160HD.**
- 3. Start the computer.**

When communication with the computer has been established, the computer recognizes the V-160HD as a USB video device and USB audio device.

\* The first time that the V-160HD is connected to the computer, the standard drivers of the operating system are installed automatically.
- 4. Operate the V-160HD to prepare the video and audio that you want to output to the computer.**
- 5. On your computer, verify the input from the V-160HD.**

Start app that supports the USB video class and audio class, and verify the video and audio that are being input from the V-160HD.

#### MEMO

#### If the video is garbled or operation is otherwise unstable

Press the [MENU] button → "VIDEO OUTPUT" → "USB OUT" → execute "CONNECTION RESET" to try reconnecting the computer with the V-160HD.

#### Video formats

You can change the USB output video format and compression method from the livestreaming app or other app used at the output destination.

The following video formats are supported.

USB OUT frame rate	Video formats		
59.94 Hz	1080/59.94p	720/59.94p	640 x 480/59.94p
29.97 Hz	1080/29.97p	720/29.97p	640 x 480/29.97p
50 Hz	1080/50p	720/50p	640 x 480/50p
25 Hz	1080/25p	720/25p	640 x 480/25p

\* Uncompressed (YUV2) and compressed (Motion JPEG) video are supported.

### Using the Loopback Function

Audio from the computer can be input to the V-160HD via USB, mixed with other audio, and returned to the computer (the loopback function).

You can add a narration to music that's played back from your computer and live-stream it, or record it using app on your computer.

### Streaming Video from a Computer

Use the dedicated "Roland Live Streamer" app to stream the video and audio from the USB output of the V-160HD with your computer.

For details on operation, refer to the Owner's Manual of "Roland Live Streamer."



You can download "Roland Live Streamer" from the Roland website.

<https://proav.roland.com/>

\* Compressed (Motion JPEG) video is not supported.

### Capturing Video on the Computer

Using dedicated "Roland Live Recorder" app, the video and audio that are output from the V-160HD via USB can be recorded on your computer.

For details on operation, refer to the Owner's Manual of "Roland Live Recorder."



You can download "Roland Live Recorder" from the Roland website.

<https://proav.roland.com/>

\* Compressed (Motion JPEG) video is not supported.

# Other Functions

## Saving/Recalling Settings (Preset Memory)

You can save the current settings, including the video/audio settings and the state of the operating panel, in preset memory and recall those settings for use when necessary. The V-160HD is provided with thirty memories.

### About the Last Memory function

The V-160HD has a built-in Last Memory feature. Last Memory is a feature that saves the state of the unit that is in effect immediately before power-down, and automatically restores the state at the next startup. The Last Memory feature is enabled by default.

If you want the unit to recall a preset memory when it starts up, press the [MENU] button → "PRESET MEMORY" → "START UP" to specify the preset memory number.

## Saving to a Preset Memory

### Preset memory 1-10

1. Press the [MODE] button several times to select "MEMORY."

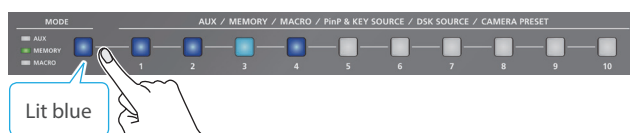

2. Long-press the MEMORY button for the number where you want to save the settings.

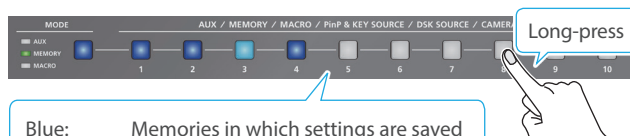

Blue: Memories in which settings are saved  
 Light blue: Currently selected memory  
 Unlit: Memories with no settings

All of the MEMORY [1]–[10] buttons are briefly illuminated in light blue, and the current settings are saved in the selected preset memory.

### Preset memory 11-30

1. Press the [MENU] button and select the memory number from "PRESET MEMORY" → "SAVE," and press the [VALUE] knob.

#### MEMO

##### About preset memories 11-30

You can use the buttons to save or recall preset memories 11-30. Use the [MENU] button → "PRESET MEMORY" → and set "NUMBER OF MEMORY SW" to "30."

The buttons listed below work as memory selection buttons.

Memory no.	Button
1-10	MEMORY [1]–[10] buttons
11-20	PGM/A [1]–[10] buttons
21-30	PST/B [1]–[10] buttons

- You can prohibit settings from being saved or initialized (p. 49) to protect the preset memories. Use the [MENU] button → "PRESET MEMORY" → and set "MEMORY PROTECT" to "ON."
- Since settings related to the system, network and so on are common to the entire unit, they are not saved in a memory. For details, refer to "SAVE" in "13: PRESET MEMORY" (p. 91).

## Recalling a Preset Memory

### Preset memory 1-10

1. Press the [MODE] button several times to select "MEMORY."

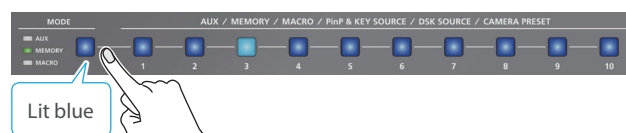

2. Press the MEMORY button for the number whose setting you want to recall.

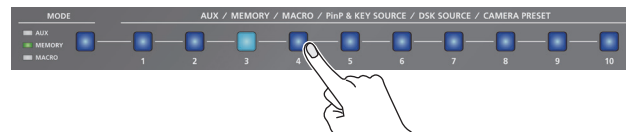

The settings are recalled.

### Preset memory 11-30

1. Press the [MENU] button and select the memory number from "PRESET MEMORY" → "LOAD," and press the [VALUE] knob.

#### MEMO

- You can choose not to recall a certain setting when recalling a preset memory. For each item selected using the [MENU] button → "PRESET MEMORY" → "LOAD PARAMETER," you can set whether to recall that setting.
- You can apply video transition effects, make an inset screen fade in and so on when you recall a preset memory. Configure the settings of the following menu items from the [MENU] button → "PRESET MEMORY"

Menu item	Explanation
FADE TIME	Sets how long the transition to the next video takes when recalling a preset memory. * The time you set is used for the parameters below.
MIX/WIPE	When this is "ON," the transition effect is applied when the preset memory is recalled.
PinP & KEY 1-4	When this is "ON," the inset screen fades in when you recall a preset memory that includes a PinP composite.
DSK 1, 2	When this is "ON," the superimposed caption and video fades in when you recall a preset memory that includes a DSK composite.



## Initializing a Preset Memory

Here's how you can initialize the settings of a specific preset memory to the factory-set condition.

1. [MENU] button → "PRESET MEMORY" → select "INITIALIZE," and press the [VALUE] knob.

```
PRESET MEMORY ( 1 / 4 )
LOAD          1: MEMORY1
SAVE          1: MEMORY1
INITIALIZE    1: MEMORY1
NAME EDIT     1: MEMORY1

START UP      LAST MEMORY
MEMORY PROTECT OFF

NUMBER OF MEMORY SW 10
```

2. Use the [VALUE] knob to select the preset memory (ALL, 1–30) that you want to initialize, and press the [VALUE] knob.

A confirmation message appears.

```
INITIALIZE MEMORY 1
ARE YOU SURE? NO YES
```

\* If you decide to cancel, press the [EXIT] button.

3. Use the [VALUE] knob to select "YES," and press the [VALUE] knob.

The preset memory is initialized. When the operation is finished, the message "COMPLETE" appears.

4. Press the [MENU] button to close the menu.

## Renaming a Preset Memory

Here's how to rename a preset memory.

1. [MENU] button → "PRESET MEMORY" → select "NAME EDIT," and press the [VALUE] knob.

```
PRESET MEMORY ( 1 / 4 )
LOAD          1: MEMORY1
SAVE          1: MEMORY1
INITIALIZE    1: MEMORY1
NAME EDIT     1: MEMORY1

START UP      LAST MEMORY
MEMORY PROTECT OFF

NUMBER OF MEMORY SW 10
```

2. Use the [VALUE] knob to select the preset memory (1–30) that you want to rename, and then press the [VALUE] knob. The PRESET MEMORY NAME screen appears.

3. Input the preset memory name.

\* You can input up to 8 characters.

```
PRESET MEMORY NAME ( 1 / 4 )

CLOSE INIT
MEMORY1

[ENTER] : EDIT
[EXIT] : DELETE
```

INIT:  
Initializes the name.

- ① Use the [VALUE] knob to move the cursor. Pressing the [EXIT] button deletes the character at the cursor location.
- ② Press the [VALUE] knob to highlight the character at the cursor location.
- ③ Use the [VALUE] knob to change the character, and press the [VALUE] knob.

4. When you have finished inputting the name, use the [VALUE] knob to select "CLOSE," and then press the [VALUE] knob.

```
PRESET MEMORY NAME ( 1 / 4 )

CLOSE INIT
Open1ng

[ENTER] : SAVE
[EXIT] : CANCEL
```

\* If you decide to cancel, press the [EXIT] button.

5. Press the [MENU] button to close the menu.

## Recording Multiple Operations to Automatically Execute (Macros)

This feature lets you record multiple operations and then automatically execute them (as a macro function). You only need to record the macro operation beforehand and then select the macro to perform the series of operations you recorded. This function is useful for executing exactly the same operations, even when a different operator is using the unit.

You can create up to 100 macros.

### Recording a Macro

A single macro can contain up to 10 different operations. You can include a macro within another macro, to make a single macro execute a more complicated set of functions.

\* The demo macro data in this unit that's available by factory default includes some recorded operations.

1. [MENU] button → "MACRO" → select "LIST EDIT," and press the [VALUE] knob.

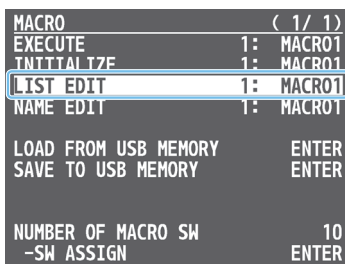

2. Use the [VALUE] knob to select the macro (1–100) you want to edit, and press the [VALUE] knob.

The list of operations recorded in the macro is shown.

3. Use the [VALUE] knob to select "ADD NEW FUNCTION," and press the [VALUE] knob.

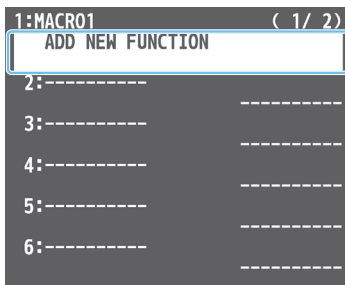

The FUNCTION EDIT menu appears.

4. Use the [VALUE] knob to select "FUNCTION," and press the [VALUE] knob.

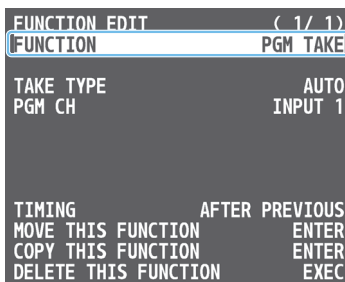

5. Select the operation to record to the macro using the [VALUE] knob, and then press the [VALUE] knob.

\* For details on the operations you can record, see "FUNCTION" in "FUNCTION EDIT" (p. 92).

6. Use the [VALUE] knob to set the related menu item.

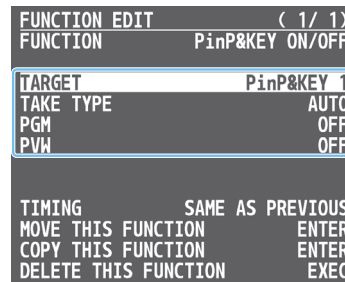

The related menu is shown according to the operation you selected in step 5.

7. Use the [VALUE] knob to select "TIMING," and press the [VALUE] knob.

8. Use the [VALUE] knob to set the timing at which the operation is executed, and then press the [VALUE] knob.

Value	Explanation
AFTER PREVIOUS	The function is executed after the preceding one. The next sequential list number is used.
SAME AS PREVIOUS	Executes the operation at the same time as the preceding one. The same list number as the previous operation is used.

\* If you place a function at the beginning of the macro, setting the timing has no effect.

9. Press the [EXIT] button to return to the previous screen.

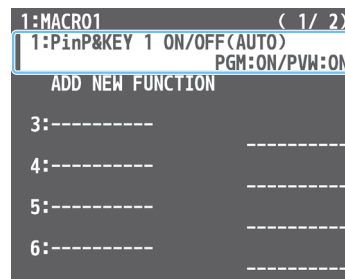

The operation is added to the list.

10. Repeat steps 3–9 to finish making the macro.

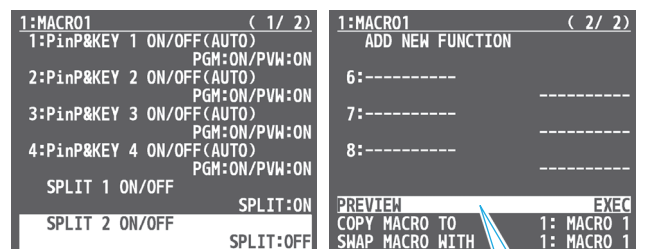

PREVIEW: Press the [VALUE] knob to preview the macro.

11. Press the [MENU] button to close the menu.

## Editing a macro

You can edit the contents of a function, change the order in which it is executed, or copy/delete a function either while creating a macro or after the macro is finished.

- In step 3 of “Recording a Macro” (p. 50), select the function you want to edit in the list, and press the [VALUE] knob.

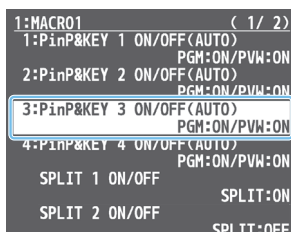

The FUNCTION EDIT menu appears.

- Edit, move, copy or delete the function.

### Editing the contents of a function

- Follow steps 4–9 in “Recording a Macro” (p. 50) to edit the contents of the function.

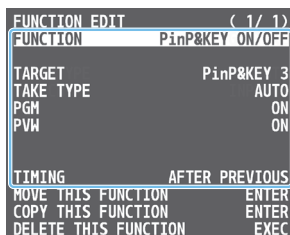

### Moving a function

- Use the [VALUE] knob to select “MOVE THIS FUNCTION,” and press the [VALUE] knob.

MOVE FUNCTION screen appears.

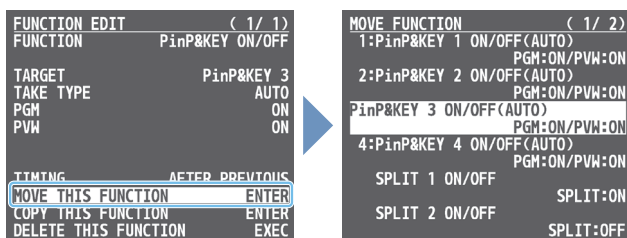

- Use the [VALUE] knob to select where you want to move the function, and then press the [VALUE] knob.

A confirmation message appears.

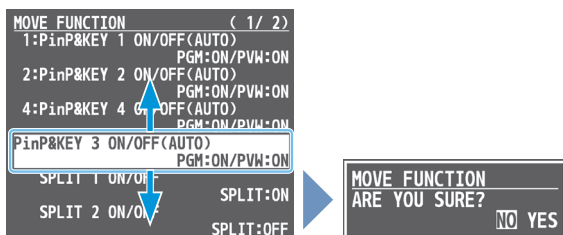

\* If you decide to cancel, press the [EXIT] button.

- Use the [VALUE] knob to select “YES,” and press the [VALUE] knob. The function is moved, and the message “COMPLETE” appears.

### Copying a function

\* Copying is disabled if the number of recorded functions have reached the limit (10).

- Use the [VALUE] knob to select “COPY THIS FUNCTION,” and press the [VALUE] knob.

The COPY FUNCTION screen appears.

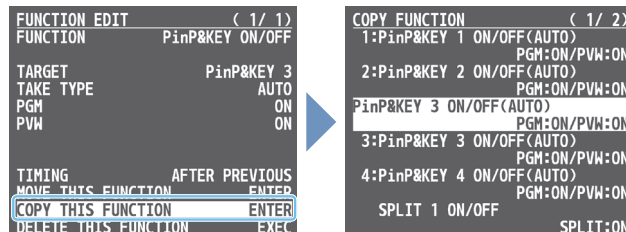

- Use the [VALUE] knob to select where you want to copy the function to, and then press the [VALUE] knob.

A confirmation message appears.

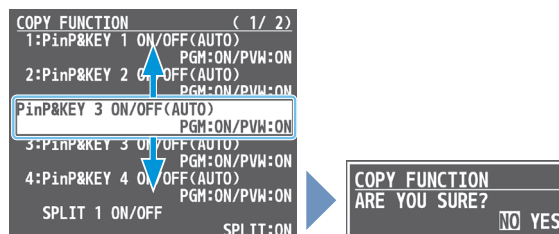

\* If you decide to cancel, press the [EXIT] button.

- Use the [VALUE] knob to select “YES,” and press the [VALUE] knob.

The function is copied, and the message “COMPLETE” appears.

### Deleting a function

- Use the [VALUE] knob to select “DELETE THIS FUNCTION,” and press the [VALUE] knob.

A confirmation message appears.

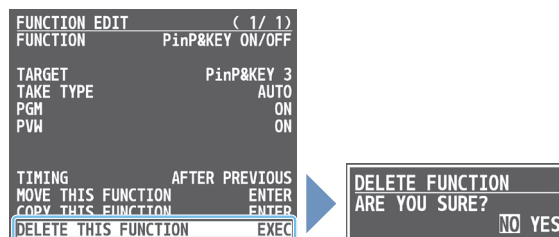

\* If you decide to cancel, press the [EXIT] button.

- Use the [VALUE] knob to select “YES,” and press the [VALUE] knob.

The function is deleted, and the message “COMPLETE” appears.

- Press the [MENU] button to close the menu.

## Executing a Macro

### Using the buttons (Macro 1–10)

1. Press the [MODE] button several times to select “MACRO.”

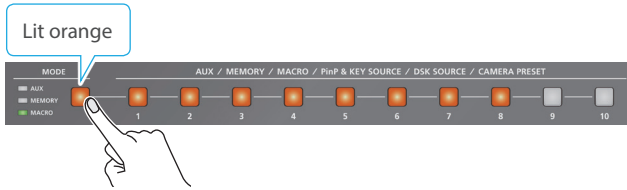

2. Press the MACRO button corresponding to the number of the macro you wish to execute.

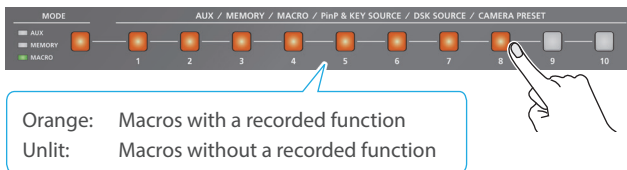

This executes the macro.

### Using the menus

1. [MENU] button → “MACRO” → select “EXECUTE,” and press the [VALUE] knob.

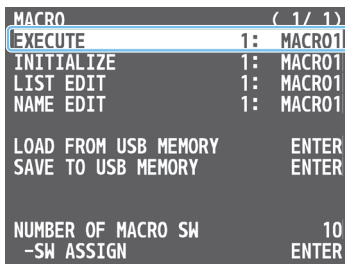

2. Use the [VALUE] knob to select the macro (1–100) that you want to execute, and press the [VALUE] knob.

A confirmation message appears.



\* If you decide to cancel, press the [EXIT] button.

3. Use the [VALUE] knob to select “YES,” and press the [VALUE] knob.

The macro is executed.

4. Press the [MENU] button to close the menu.

### MEMO

#### Using the cross-point buttons to select macros

When “MACRO” is selected on the [MODE] button, the cross-point buttons function as macro selection buttons.

Use the [MENU] button → “MACRO” → and set “NUMBER OF MACRO SW” to “30.”

#### Changing the macro assigned to a button

You can change the macros assigned to the buttons.

From the [MENU] button → “MACRO” → “SW ASSIGN,” specify a macro (1–100) to assign to the respective button, using the menu items shown below.

Menu item	Explanation
MACRO 1–10	MEMORY [1]–[10] buttons
PGM/A 1–10 (*1)	PGM/A [1]–[10] buttons
PST/B 1–10 (*1)	PST/B [1]–[10] buttons

(\*1) This can be set if “NUMBER OF MACRO SW” is “30.”

## Copying Macro Settings

Here's how to copy the settings from one macro to another.

1. [MENU] button → "MACRO" → select "LIST EDIT," and press the [VALUE] knob.

```
MACRO ( 1 / 1 )
EXECUTE 1: MACRO1
INITIAL TZE 1: MACRO1
LIST EDIT 1: MACRO1
NAME EDIT 1: MACRO1

LOAD FROM USB MEMORY ENTER
SAVE TO USB MEMORY ENTER

NUMBER OF MACRO SW 10
-SW ASSIGN ENTER
```

2. Use the [VALUE] knob to select the copy source macro (1–100), and press the [VALUE] knob.

The list of operations recorded in the macro is shown.

3. Use the [VALUE] knob to select "COPY MACRO TO," and press the [VALUE] knob.

```
1:MACRO 1 ( 2 / 2 )
4:PinP&KEY 2 ON/OFF(AUTO)
PGM:ON/PVW:ON
5:PinP&KEY 3 ON/OFF(AUTO)
PGM:ON/PVW:ON
6:PinP&KEY 4 ON/OFF(AUTO)
PGM:ON/PVW:ON
ADD NEW FUNCTION

PREVIEW EXEC
COPY MACRO TO 2: MACRO2
SWAP MACRO WITH 2: MACRO2
```

4. Use the [VALUE] knob to select the copy destination macro, and then press the [VALUE] knob.

A confirmation message appears.

```
COPY MACRO SETTINGS
ARE YOU SURE?
NO YES
```

\* If you decide to cancel, press the [EXIT] button.

5. Use the [VALUE] knob to select "YES," and press the [VALUE] knob.

The macro settings are copied. When the operation is finished, the message "COMPLETE" appears.

6. Press the [MENU] button to close the menu.

## Swapping the Macro Settings

Here's how to swap settings between macros.

1. [MENU] button → "MACRO" → select "LIST EDIT," and press the [VALUE] knob.

```
MACRO ( 1 / 1 )
EXECUTE 1: MACRO1
INITIAL TZE 1: MACRO1
LIST EDIT 1: MACRO1
NAME EDIT 1: MACRO1

LOAD FROM USB MEMORY ENTER
SAVE TO USB MEMORY ENTER

NUMBER OF MACRO SW 10
-SW ASSIGN ENTER
```

2. Use the [VALUE] knob to select the swap source macro (1–100), and press the [VALUE] knob.

The list of operations recorded in the macro is shown.

3. Use the [VALUE] knob to select "SWAP MACRO WITH," and press the [VALUE] knob.

```
1:MACRO 1 ( 2 / 2 )
4:PinP&KEY 2 ON/OFF(AUTO)
PGM:ON/PVW:ON
5:PinP&KEY 3 ON/OFF(AUTO)
PGM:ON/PVW:ON
6:PinP&KEY 4 ON/OFF(AUTO)
PGM:ON/PVW:ON
ADD NEW FUNCTION

PREVIEW EXEC
COPY MACRO TO 2: MACRO2
SWAP MACRO WITH 2: MACRO2
```

4. Use the [VALUE] knob to select the swap destination macro, and press the [VALUE] knob.

A confirmation message appears.

```
SWAP MACRO SETTINGS
ARE YOU SURE?
NO YES
```

\* If you decide to cancel, press the [EXIT] button.

5. Use the [VALUE] knob to select "YES," and press the [VALUE] knob.

This swaps the settings of the macros. When the operation is finished, the message "COMPLETE" appears.

6. Press the [MENU] button to close the menu.

## Initializing a Macro

You can initialize a macro and completely erase its settings.

1. [MENU] button → “MACRO” → select “INITIALIZE,” and press the [VALUE] knob.

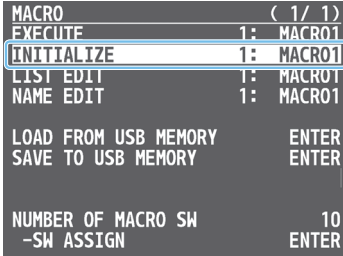

2. Turn the [VALUE] knob to the macro you wish to select (ALL, 1–100), and press the [VALUE] knob.

A confirmation message appears.



\* If you decide to cancel, press the [EXIT] button.

3. Use the [VALUE] knob to select “YES,” and press the [VALUE] knob.

The macro is initialized. When the operation is finished, the message “COMPLETE” appears.

4. Press the [MENU] button to close the menu.

### MEMO

#### About the macro demo data

Once you perform a factory reset (p. 73), any demo data you have edited or deleted is restored to its factory default settings.

## Renaming a Macro

Here’s how to rename a macro.

1. [MENU] button → “MACRO” → select “NAME EDIT,” and press the [VALUE] knob.

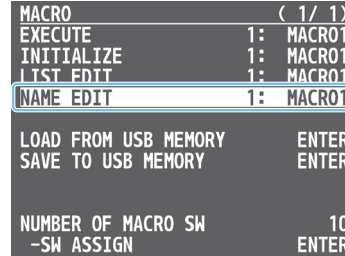

2. Use the [VALUE] knob to select the macro (1–100) that you want to rename, and then press the [VALUE] knob.

The MACRO NAME EDIT screen appears.

3. Input the macro name.

\* You can input up to 8 characters.

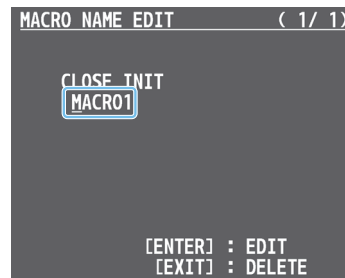

INIT:  
Initializes the name.

- ① Use the [VALUE] knob to move the cursor.  
Pressing the [EXIT] button deletes the character at the cursor location.
- ② Press the [VALUE] knob to highlight the character at the cursor location.
- ③ Use the [VALUE] knob to change the character, and press the [VALUE] knob.

4. When you have finished inputting the name, use the [VALUE] knob to select “CLOSE,” and then press the [VALUE] knob.



\* If you decide to cancel, press the [EXIT] button.

5. Press the [MENU] button to close the menu.

## Saving/Loading the Macro Settings

You can group together the macro settings (1–100) into a single file (.RMC) and save it to a USB flash drive connected to the USB MEMORY port. You can access the saved macro setting file on the USB flash drive and load it into the unit for use when needed.

### NOTE

- When using a USB flash drive for the first time, you must format it using the V-160HD (p. 64).
- Never turn off the power or remove the USB flash drive while the message “PLEASE WAIT” is shown.
- Depending on the USB flash drive, recognition of the flash drive might take some time.

### Saving a new file

1. Connect the USB flash drive to the USB MEMORY port.
2. [MENU] button → “MACRO” → select “SAVE TO USB MEMORY,” and press the [VALUE] knob.

```
MACRO ( 1 / 1)
EXECUTE 1: MACRO1
INITIALIZE 1: MACRO1
LIST EDIT 1: MACRO1
NAME EDIT 1: MACRO1
LOAD FROM USB MEMORY ENTER
SAVE TO USB MEMORY ENTER
NUMBER OF MACRO SW 10
-SW ASSIGN ENTER
```

The macro setting files in the USB flash drive are listed.

3. Use the [VALUE] knob to select “NEW FILE...,” and press the [VALUE] knob.

```
SAVE MACRO DATA ( 1 / 1)
NEW FILE...
[ENTER] : ENTER
[EXIT] : EXIT
```

4. Enter the file name.

\* You can enter a text string of up to 16 characters in length.

```
SAVE MACRO DATA ( 1 / 1)
SAVE_EXIT
MACRO_DATA_0000 .RMC
[ENTER] : EDIT
[EXIT] : DELETE
```

- ① Use the [VALUE] knob to move the cursor. Pressing the [EXIT] button deletes the character at the cursor location.
- ② Press the [VALUE] knob to highlight the character at the cursor location.
- ③ Use the [VALUE] knob to change the character, and press the [VALUE] knob.

5. When you finish entering the name, use the [VALUE] knob to select “SAVE,” and press the [VALUE] knob.

A confirmation message appears.

```
SAVE MACRO DATA ( 1 / 1)
SAVE_EXIT
MACRO_settings01.RMC
[ENTER] : SAVE
[EXIT] : EXIT
```

```
SAVE MACRO_settings0
ARE YOU SURE?
NO YES
```

\* If you decide to cancel, press the [EXIT] button.

6. Use the [VALUE] knob to select “YES,” and press the [VALUE] knob.

The macro settings file (.RMC) is saved to the USB flash drive. When the operation is finished, the message “COMPLETE” appears.

7. Press the [MENU] button to close the menu.

### Overwrite-saving

1. Connect the USB flash drive to the USB MEMORY port.
2. [MENU] button → “MACRO” → select “SAVE TO USB MEMORY,” and press the [VALUE] knob.

The macro setting files in the USB flash drive are listed.

3. Use the [VALUE] knob select the macro settings file that you want to overwrite, and press the [VALUE] knob.

A confirmation message appears.

```
SAVE MACRO DATA ( 1 / 1)
1:MACRO_settings01.RMC
2:MACRO_settings02.RMC
NEW FILE...
[ENTER] : OVERWRITE
[EXIT] : EXIT
```

```
SAVE MACRO_settings0
ARE YOU SURE?
NO YES
```

\* If you decide to cancel, press the [EXIT] button.

4. Use the [VALUE] knob to select “YES,” and press the [VALUE] knob.

The macro settings file is overwritten. When the operation is finished, the message “COMPLETE” appears.

5. Press the [MENU] button to close the menu.

## Loading

Here's how to load the macro settings that are saved on a USB flash drive. Loading the settings overwrites the current settings for the macros (1–100).

1. [MENU] button → “MACRO” → select “LOAD FROM USB MEMORY,” and press the [VALUE] knob.

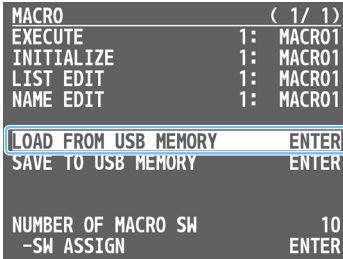

The macro setting files in the USB flash drive are listed.

2. Use the [VALUE] knob to select the macro settings file that you want to load, and press the [VALUE] knob.

A confirmation message appears.

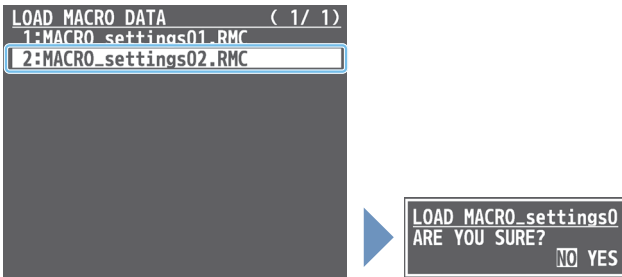

\* If you decide to cancel, press the [EXIT] button.

3. Use the [VALUE] knob to select “YES,” and press the [VALUE] knob.

The macro settings are loaded. When the operation is finished, the message “COMPLETE” appears.

4. Press the [MENU] button to close the menu.



## Combining Preset Memories and Macros for Operations (Sequencer)

The sequencer function lets you record functions such as recalling preset memories or macros, and then execute them in the order you specify. This lets you recreate the desired functions like editing the screen layout or inserting a title, by preparing the functions in line with how the events progress and then simply pressing the [NEXT] button. This feature is useful for smoothly carrying out operations at the place where you're working.

### Recording to the Sequencer

Three types of functions can be recorded in the sequencer, including recalling a preset memory, executing a macro and switching between final output videos. Create a list of the functions you want to execute in order.

A list can contain up to 1,000 functions.

#### MEMO

The demo data in this unit that's available by factory default includes a list of recorded functions. You can completely erase the contents of this list by initializing it (p. 62).

1. [MENU] button → "SEQUENCER" → select "LIST EDIT," and press the [VALUE] knob.

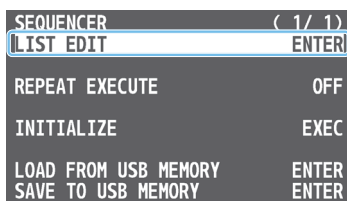

The list of operations recorded in the sequencer is shown.

2. Use the [VALUE] knob to select "ADD NEW FUNCTION," and press the [VALUE] knob.



The FUNCTION EDIT menu appears.

3. Use the [VALUE] knob to select "FUNCTION," and press the [VALUE] knob.

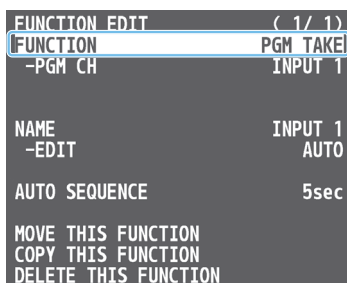

4. Use the [VALUE] knob to select the function to record to the sequencer, and then press the [VALUE] knob.

Value	Explanation
PGM TAKE	Switches the final output video.
PRESET MEMORY	Recalls a preset memory.
MACRO	Executes a macro.

5. Use the [VALUE] knob to set the related menu item.

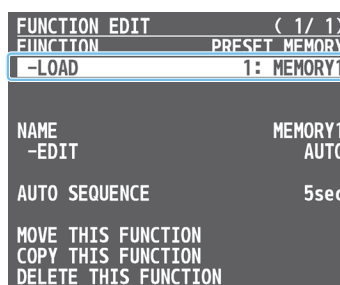

The related menu is shown according to the operation you selected in step 4.

6. Press the [EXIT] button to return to the previous screen.



The operation is added to the list.

7. Repeat steps 2–6 to finish making the list.

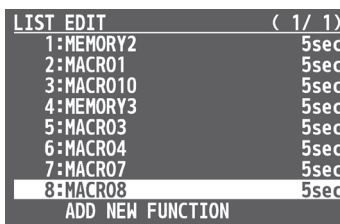

8. Press the [MENU] button to close the menu.

## Editing a list

You can edit the contents of a function, change the order in which it is executed, or copy/delete a function while creating a list or after you've finished the list.

- In step 2 of "Recording to the Sequencer" (p. 57), select the function you want to edit in the list, and press the [VALUE] knob.

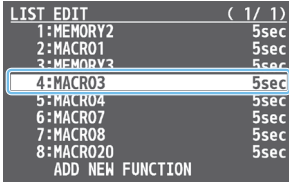

The FUNCTION EDIT menu appears.

- Edit, move, copy or delete the function.

### Editing the contents of a function

- Follow steps 3–6 in "Recording to the Sequencer" (p. 57) to edit the contents of the function.

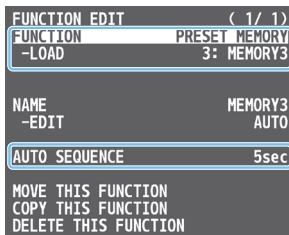

### Moving a function

- Use the [VALUE] knob to select "MOVE THIS FUNCTION," and press the [VALUE] knob.

The MOVE FUNCTION screen appears.

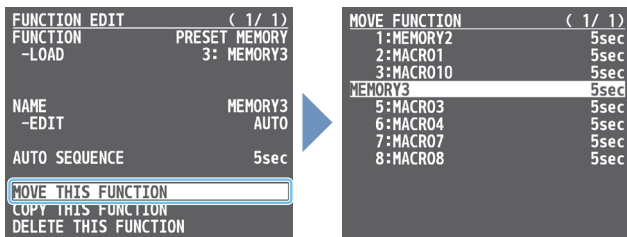

- Use the [VALUE] knob to select where you want to move the function, and then press the [VALUE] knob.

A confirmation message appears.

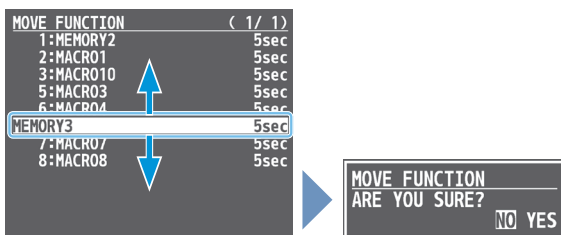

\* If you decide to cancel, press the [EXIT] button.

- Use the [VALUE] knob to select "YES," and press the [VALUE] knob. The function is moved, and the message "COMPLETE" appears.

### Copying a function

- Use the [VALUE] knob to select "COPY THIS FUNCTION," and press the [VALUE] knob.

The COPY FUNCTION screen appears.

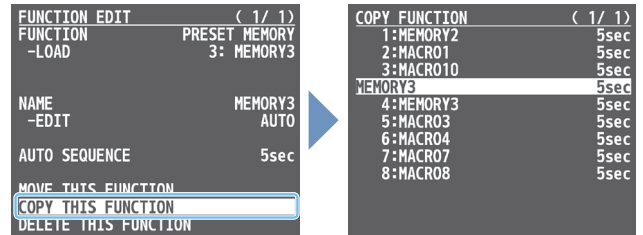

- Use the [VALUE] knob to select where you want to copy the function to, and then press the [VALUE] knob.

A confirmation message appears.

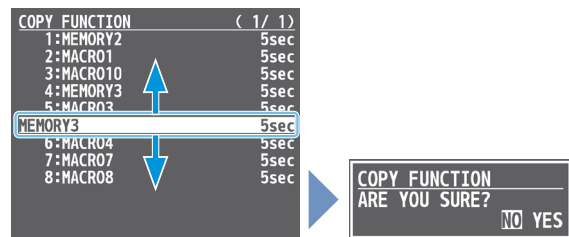

\* If you decide to cancel, press the [EXIT] button.

- Use the [VALUE] knob to select "YES," and press the [VALUE] knob.

The function is copied, and the message "COMPLETE" appears.

### Deleting a function

- Use the [VALUE] knob to select "DELETE THIS FUNCTION," and press the [VALUE] knob.

A confirmation message appears.

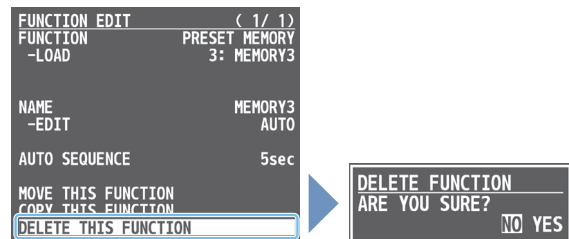

\* If you decide to cancel, press the [EXIT] button.

- Use the [VALUE] knob to select "YES," and press the [VALUE] knob.

The function is deleted, and the message "COMPLETE" appears.

- Press the [MENU] button to close the menu.

## Running the Sequencer

Press the button to make the functions recorded in the sequencer execute one at a time.

### 1. Long-press the SEQUENCER [ON] button to turn the sequencer function on (the button lights up).

The list of operations recorded in the sequencer is shown.

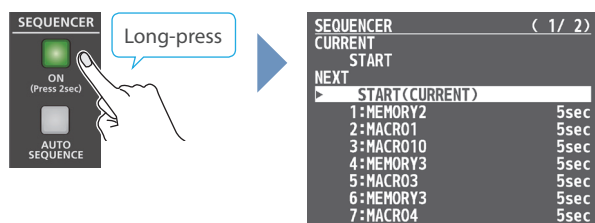

### 2. Press the [NEXT] button.

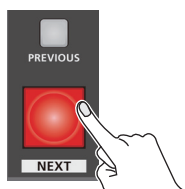

The first function in the list is executed.

The button blinks while the function is executing. When the function ends, the button remains lit.

### 3. Press the [NEXT] button at the timing when you want the next function to execute.

The function is executed.

#### [PREVIOUS] button

Press the [PREVIOUS] button if you want to return to the state at which the previous function was completed.

### 4. Repeat step 3.

### 5. Long-press the SEQUENCER [ON] button again to turn the sequencer function off.

#### MEMO

##### Repeatedly executing a function in the list

You can repeatedly execute functions that are in a list. Once the last function is finished, press the [NEXT] button to execute the function at the beginning of the list.

Use the [MENU] button → "SEQUENCER" → and set "REPEAT EXECUTE" to "ON."

##### Executing a function from the middle of the list

Use the [VALUE] knob to select a function from the list, and then press the [VALUE] knob to set the selected function to its completed state. You can press the [NEXT] button to execute the next function afterwards.

## Making the Sequencer Run Automatically (Auto Sequence)

Use the auto sequence feature when you want to make the functions recorded in the sequencer execute automatically.

### Configuring the auto sequence settings

Set the action or function that's executed when the sequencer advances to the next function. You can add some delay time before the next function is executed, or pause the execution of a function.

1. [MENU] button → "SEQUENCER" → select "LIST EDIT," and press the [VALUE] knob.

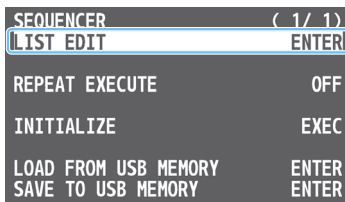

The list of operations recorded in the sequencer is shown.

2. Select the function in the list, and press the [VALUE] knob.

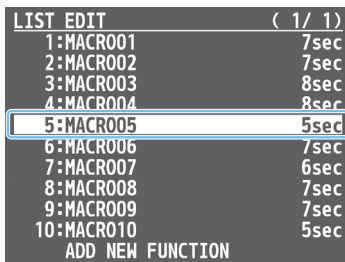

The FUNCTION EDIT menu appears.

3. Use the [VALUE] knob to select "AUTO SEQUENCE," and press the [VALUE] knob.

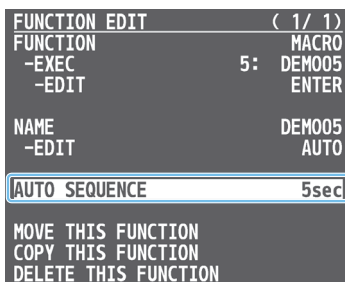

4. Use the [VALUE] knob to set the action that's executed when the sequencer advances to the next function, and then press the [VALUE] knob.

Value	Explanation
PAUSE	Pauses the auto sequence.
AUTO	Executes the next operation in the sequence.
1-120sec	Executes the next operation after delaying for a specified amount of time.

5. Press the [MENU] button to close the menu.

### Running the auto sequence

1. Long-press the SEQUENCER [ON] button to turn the sequencer function on (the button lights up).

The list of operations recorded in the sequencer is shown.

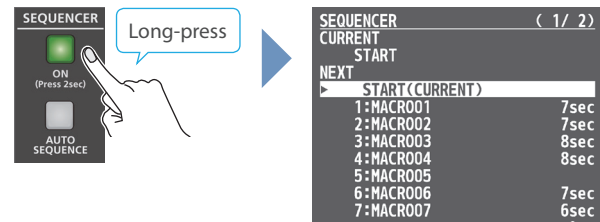

Check which action is executed when the sequencer moves to the next function. When this is set to "PAUSE," this is blank.

2. Press the [AUTO SEQUENCE] button to turn the auto sequence function on (the button lights up).

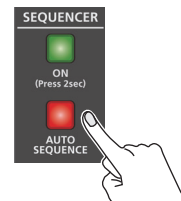

The functions in the list are executed at the beginning. The [NEXT] button blinks while a function is executing.

When the last function is finished, the sequence stops automatically.

#### When a function is set to "PAUSE"

When the function is finished, the [AUTO SEQUENCE] button blinks and auto sequence is paused. You can press the [NEXT] button to manually execute the next function.

\* When executing a function that's set to a value other than "PAUSE," the auto sequence is resumed.

3. Press the [AUTO SEQUENCE] button again to turn off the auto sequence.
4. Long-press the SEQUENCER [ON] button again to turn the sequencer function off.

#### MEMO

You can repeatedly execute functions that are in a list. When the last function is finished, the sequencer returns to the beginning.

Use the [MENU] button → "SEQUENCER" → and set "REPEAT EXECUTE" to "ON."

## Saving/Loading the Sequencer Settings

You can save the sequencer settings as a single file (.RSQ) to a USB flash drive connected to the USB MEMORY port.

You can access the saved sequence file on the USB flash drive and load it into the unit for use when needed.

### NOTE

- When using a USB flash drive for the first time, you must format it using the V-160HD (p. 64).
- Never turn off the power or remove the USB flash drive while the message "PLEASE WAIT" is shown.
- Depending on the USB flash drive, recognition of the flash drive might take some time.

### Saving a new file

1. Connect the USB flash drive to the USB MEMORY port.
2. [MENU] button → "SEQUENCER" → select "SAVE TO USB MEMORY," and press the [VALUE] knob.

```

SEQUENCER          ( 1 / 1 )
LIST EDIT          ENTER
REPEAT EXECUTE    OFF
INITIALIZE        EXEC
LOAD FROM USB MEMORY  ENTER
SAVE TO USB MEMORY  ENTER
  
```

The sequence files in the USB flash drive are listed.

3. Use the [VALUE] knob to select "NEW FILE...," and press the [VALUE] knob.

```

SAVE SEQUENCER DATA ( 1 / 1 )
NEW FILE...
[ENTER] : ENTER
[EXIT] : EXIT
  
```

4. Enter the file name.

\* You can enter a text string of up to 16 characters in length.

```

SAVE SEQUENCER DATA ( 1 / 1 )
SAVE EXIT
SEQ_DATA_0001 .RSQ
[ENTER] : EDIT
[EXIT] : DELETE
  
```

- ① Use the [VALUE] knob to move the cursor.  
Pressing the [EXIT] button deletes the character at the cursor location.
- ② Press the [VALUE] knob to highlight the character at the cursor location.
- ③ Use the [VALUE] knob to change the character, and press the [VALUE] knob.

5. When you finish entering the name, use the [VALUE] knob to select "SAVE," and press the [VALUE] knob.

A confirmation message appears.

```

SAVE SEQUENCER DATA ( 1 / 1 )
SAVE EXIT
SEQ_Live001 .RSQ
[ENTER] : SAVE
[EXIT] : EXIT
  
```

```

SAVE_SEQ_Live001.RSQ
ARE YOU SURE? NO YES
  
```

\* If you decide to cancel, press the [EXIT] button.

6. Use the [VALUE] knob to select "YES," and press the [VALUE] knob.

The sequence file (.RSQ) is saved to the USB flash drive. When the operation is finished, the message "COMPLETE" appears.

7. Press the [MENU] button to close the menu.

### Overwrite-saving

1. Connect the USB flash drive to the USB MEMORY port.
2. [MENU] button → "SEQUENCER" → select "SAVE TO USB MEMORY," and press the [VALUE] knob.

The sequence files in the USB flash drive are listed.

3. Use the [VALUE] knob select the sequence file that you want to overwrite, and press the [VALUE] knob.

A confirmation message appears.

```

SAVE SEQUENCER DATA ( 1 / 1 )
1:SEQ_Live001.RSQ
2:SEQ_Show01.RSQ
NEW FILE...
[ENTER] : OVERWRITE
[EXIT] : EXIT
  
```

```

SAVE_SEQ_Show01.RSQ
ARE YOU SURE? NO YES
  
```

\* If you decide to cancel, press the [EXIT] button.

4. Use the [VALUE] knob to select "YES," and press the [VALUE] knob.

The sequence file is overwritten. When the operation is finished, the message "COMPLETE" appears.

5. Press the [MENU] button to close the menu.

## Loading

Here's how to load the sequencer settings that are saved on a USB flash drive. When you load settings, the current sequencer settings are overwritten.

1. [MENU] button → "SEQUENCER" → select "LOAD FROM USB MEMORY," and press the [VALUE] knob.

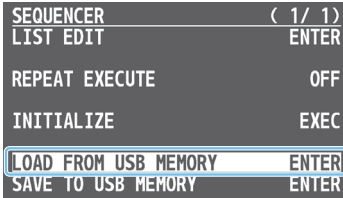

The sequence files in the USB flash drive are listed.

2. Use the [VALUE] knob to select the sequence file that you want to load, and press the [VALUE] knob.

A confirmation message appears.

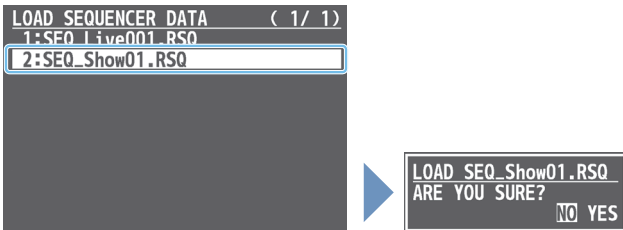

\* If you decide to cancel, press the [EXIT] button.

3. Use the [VALUE] knob to select "YES," and press the [VALUE] knob.

The sequencer settings are loaded. When the operation is finished, the message "COMPLETE" appears.

4. Press the [MENU] button to close the menu.

## Initializing the Sequencer

Here's how to initialize the sequencer and erase all the settings.

1. [MENU] button → "SEQUENCER" → select "INITIALIZE," and press the [VALUE] knob.

A confirmation message appears.

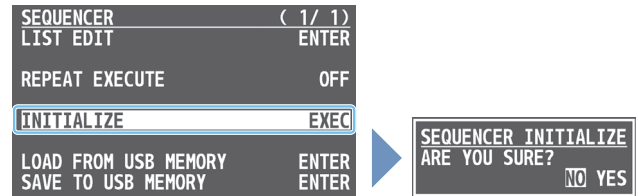

\* If you decide to cancel, press the [EXIT] button.

2. Use the [VALUE] knob to select "YES," and press the [VALUE] knob.

The sequencer is initialized. When the operation is finished, the message "COMPLETE" appears.

3. Press the [MENU] button to close the menu.

### MEMO

#### About the sequencer demo data

Once you perform a factory reset (p. 73), any demo data you have edited or deleted is restored to its factory default settings.

## Backing Up and Restoring the Unit's Settings

You can group together the unit's settings into a single file (.V16) and back up it to a USB flash drive connected to the USB MEMORY port. You can access the backed up setting file on the USB flash drive and restore it into the unit for use when needed.

### NOTE

- When using a USB flash drive for the first time, you must format it using the V-160HD (p. 64).
- Never turn off the power or remove the USB flash drive while the message "PLEASE WAIT" is shown.
- Depending on the USB flash drive, recognition of the flash drive might take some time.

## Backing Up

### Saving a new file

1. Connect the USB flash drive to the USB MEMORY port.
2. [MENU] button → "USB MEMORY" → select "BACKUP ALL SETTINGS," and press the [VALUE] knob.

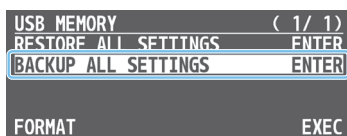

The settings files in the USB flash drive are listed.

3. Use the [VALUE] knob to select "NEW FILE..." and press the [VALUE] knob.

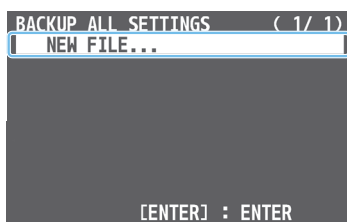

4. Enter the file name.

\* You can enter a text string of up to 16 characters in length.

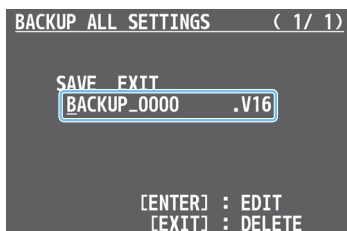

- ① Use the [VALUE] knob to move the cursor.  
Pressing the [EXIT] button deletes the character at the cursor location.
- ② Press the [VALUE] knob to highlight the character at the cursor location.
- ③ Use the [VALUE] knob to change the character, and press the [VALUE] knob.

5. When you finish entering the name, use the [VALUE] knob to select "SAVE," and press the [VALUE] knob.

A confirmation message appears.



\* If you decide to cancel, press the [EXIT] button.

6. Use the [VALUE] knob to select "YES," and press the [VALUE] knob.

The settings file (.V16) is backed up on the USB flash drive. When the operation is finished, the message "COMPLETE" appears.

7. Press the [MENU] button to close the menu.

### Overwrite-saving

1. Connect the USB flash drive to the USB MEMORY port.
2. [MENU] button → "USB MEMORY" → select "BACKUP ALL SETTINGS," and press the [VALUE] knob.

The settings files in the USB flash drive are listed.

3. Use the [VALUE] knob select the settings file that you want to overwrite, and press the [VALUE] knob.

A confirmation message appears.

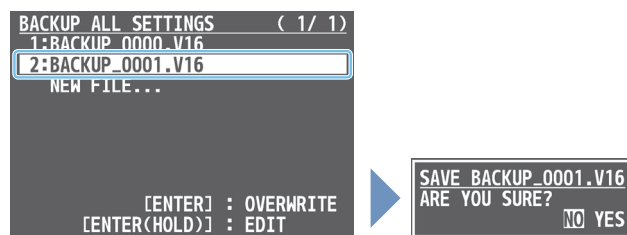

\* If you decide to cancel, press the [EXIT] button.

4. Use the [VALUE] knob to select "YES," and press the [VALUE] knob.

The settings file is overwrite-saved. When the operation is finished, the message "COMPLETE" appears.

5. Press the [MENU] button to close the menu.

### MEMO

- When you select a settings file in step 3 and long-press the [VALUE] knob, the edit screen appears with the file name preserved. Edit the file name as necessary to save it as a different file.
- Some settings are not saved to the file, such as the "TEST PATTERN" and "TEST TONE" settings in the SYSTEM menu.

## Restoring

Here's how to restore this unit's settings that you saved on a USB flash drive. When you restore settings, the current settings are overwritten.

1. [MENU] button → "USB MEMORY" → select "RESTORE ALL SETTINGS," and press the [VALUE] knob.

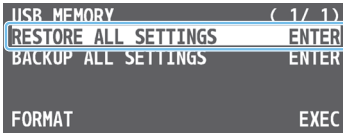

The settings files in the USB flash drive are listed.

2. Use the [VALUE] knob to select the file you want to restore, and press the [VALUE] knob.

A confirmation message appears.

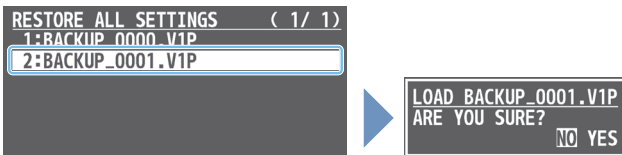

\* If you decide to cancel, press the [EXIT] button.

3. Use the [VALUE] knob to select "YES," and press the [VALUE] knob.

The settings are restored. When the operation is finished, the message "COMPLETE" appears.

4. Press the [MENU] button to close the menu.

## Formatting a USB Flash Drive

The first time that you use a USB flash drive, you must use the V-160HD to format it.

### NOTE

- A USB flash drive that was not formatted by the V-160HD will not be recognized.
- Never turn off the power or remove the USB flash drive while the message "PLEASE WAIT" is shown.
- When you format a USB flash drive, all data on that USB flash drive is erased. If the drive contains important data, back it up to your computer before you format the drive.

1. Connect the USB flash drive to the USB MEMORY port.

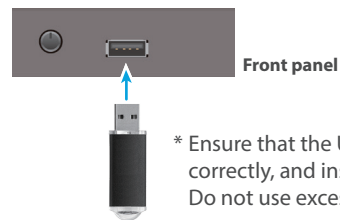

\* Ensure that the USB flash drive is oriented correctly, and insert it all the way into the port. Do not use excessive force.

2. [MENU] button → "USB MEMORY" → select "FORMAT," and press the [VALUE] knob.

A confirmation message appears.



\* If you decide to cancel, press the [EXIT] button.

3. Use the [VALUE] knob to select "YES," and press the [VALUE] knob.

Formatting is executed. When the operation is finished, the message "COMPLETE" appears.

4. Press the [MENU] button to close the menu.



## Assigning Functions to the USER Buttons

You can assign the functions you want to the USER [1]–[4] buttons. By doing this, the function you assigned is executed when you press a USER button.

\* The functions printed on the operation panel are assigned to the USER buttons by factory default.

1. [MENU] button → “SYSTEM” → select “USER SW ASSIGN,” and press the [VALUE] knob.

The USER SW ASSIGN menu appears.

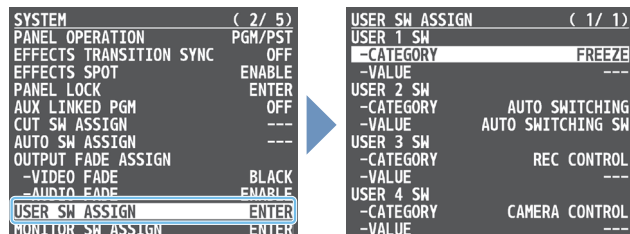

2. Use the [VALUE] knob to select USER 1–4 “CATEGORY” and “VALUE,” and press the [VALUE] knob.
3. Use the [VALUE] knob to select the functions assigned to the USER [1]–[4] buttons and then press the [VALUE] knob.

### ●CATEGORY

Menu item	Explanation
N/A	No function is assigned.
FREEZE	Turns the freeze function on/off.
AUTO SWITCHING	<b>AUTO SWITCHING SW:</b> Turns the auto switching function on/off.  <b>BPM TAP:</b> When “TYPE” in the AUTO SWITCHING menu is “BPM SYNC,” you can set the BPM according to the tempo at which you press the button. The buttons flash in sync with the current BPM setting.
INPUT ASSIGN	Each time you press a button, the video source assigned to the specified cross-point button switches to the following sources in order: [HDMI 1 → 8] → [SDI 1 → 8] → [STILL 1 → 16]
STILL OUTPUT	Pauses the normal output, and previews or final outputs a cut of the still image.
AUDIO INPUT MUTE	Turns the mute function on/off for the input audio.
AUDIO OUTPUT MUTE	Turns the mute function on/off for the output audio.
VOICE CHANGER SW	Turns the voice changer on/off.
REVERB (MOMENTARY)	Reverb turns on only while the button is pressed.
REVERB (ALTERNATE)	Turns reverb on/off.
INPUT SCAN	Each time you press a button, the INPUT 1–10 video changes in order.
MEMORY SCAN	Each time you press a button, preset memories 1–30 are recalled in order.
REC CONTROL	Controls the recorder's video record start/stop if a recorder that supports REC control functionality is connected (p. 65).
GPO (ONE SHOT)	Outputs a control signal for 0.5 seconds.
GPO (ALTERNATE)	The control signal output is switched on/off while the button is pressed.
CAMERA CONTROL	Turns the camera control function on/off.
Bluetooth CONTROL	Turns the Bluetooth function on/off. Long-press the button to begin pairing.

### ●VALUE

Configures the detailed settings related to “CATEGORY.”

4. Press the [MENU] button to close the menu.

## Controlling an External Recorder’s Video Record Start/Stop from the V-160HD

Connect a recorder that supports REC control functionality via HDMI to control REC START/STOP on the recorder from the V-160HD (REC control function).

For more about recorders that support the REC control function, refer to the Roland website.

<https://proav.roland.com/>

## Settings

### USER button functions

To use the REC control function, you need to assign the recorder's video recording start/stop functions to a USER button.

\* The record start/stop function is assigned to the USER [3] button by factory default.

1. Following the steps in “Assigning Functions to the USER Buttons” on this page, assign the “REC CONTROL” function to a USER button.

### Turning REC control on/off

1. [MENU] button → “VIDEO OUTPUT” → “HDMI OUT 1–3” → and set “REC CONTROL” to “ON.”

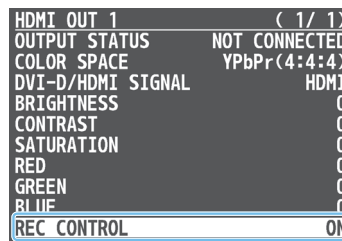

## Operation

1. Press the USER button to which REC START/STOP is assigned.

Each time you press the button, the recorder switches between video record start/stop.

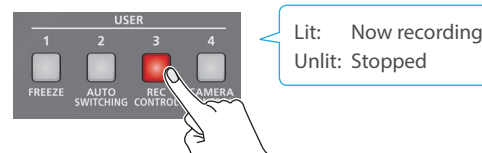

### NOTE

The lights of the USER buttons show the status of the V-160HD, and are not linked with the recorder's status.

For instance, if the recorder stops recording for some reason while the USER button are lit, these buttons do not automatically go dark in response.

## Remotely Controlling a PTZ Camera

You can connect up to sixteen cameras via the LAN CONTROL port and remotely control them from the V-160HD.

This allows you to control cameras made by JVC, Panasonic, Canon, PTZOptics, and Avonic, and cameras that support VISCA over IP (such as Sony).

\* Refer also to the owner's manual of your camera.

### Network Settings on the Camera

In order to control a camera from the V-160HD, you need to make network settings on the camera. You can register up to sixteen cameras.

1. [MENU] button → "CAMERA CONTROL" → select the menu item shown below, and press the [VALUE] knob.

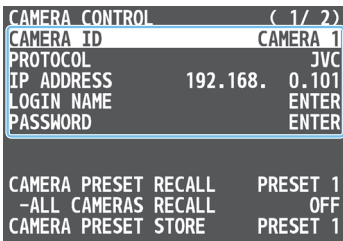

Menu item	Explanation
CAMERA ID	Selects the camera to be controlled.
PROTOCOL	Specifies the camera's protocol.
CAMERA IP ADDRESS	Input the camera's IP address.
LOGIN NAME	<b>When "PROTOCOL" is "JVC"</b> Press the [VALUE] knob to display the LOGIN NAME screen. Enter the log-in name needed to connect with the camera.
PASSWORD	<b>When "PROTOCOL" is "JVC"</b> Press the [VALUE] knob to display the PASSWORD screen. Enter the password needed to connect with the camera.

2. Use the [VALUE] knob to change the value of the setting, and press the [VALUE] knob.
3. Press the [MENU] button to close the menu.

### Registering Camera Settings in a Preset

Up to ten sets of settings such as camera position and focus can be registered as presets.

A registered preset can be recalled when needed.

\* Presets are saved in the camera itself.

1. [MENU] button → "CAMERA CONTROL" → select "CAMERA ID," and press the [VALUE] knob.

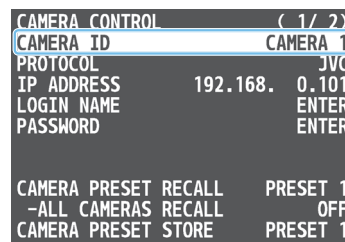

2. Use the [VALUE] knob to select the camera that you want to control, and press the [VALUE] knob.
3. Use the [VALUE] knob to select the menu item shown below, and press the [VALUE] knob.

Menu item	Explanation
PAN	Adjusts the horizontal position. (*1)
TILT	Adjusts the vertical position. (*1)
SPEED	Adjusts the speed at which the camera changes direction.
ZOOM	Adjusts the zoom position. (*1)
FOCUS	Adjusts the focal point. (*1)
AUTO FOCUS	When this is "ON," the focal point is set automatically.
EXPOSURE	Specifies the exposure mode.
TALLY CH	Specifies the connector from which the camera video is input. When the camera video from the V-160HD is the final output, the camera's tally light is lit.

(\*1) You can control the camera while holding down the [VALUE] knob.

4. Use the [VALUE] knob to apply the setting.
5. Use the [VALUE] knob to select "CAMERA PRESET STORE," and press the [VALUE] knob.
6. Use the [VALUE] knob to select the preset number (PRESET 1–10) in which you want to register the settings, and press the [VALUE] knob.

A confirmation message appears.



\* If you decide to cancel, press the [EXIT] button.

7. Use the [VALUE] knob to select "YES," and press the [VALUE] knob.

The camera settings are registered in the preset.

8. Press the [MENU] button to close the menu.

## Recalling a Preset

This shows you how to recall the presets registered in your camera. You can also recall presets from multiple cameras at the same time.

1. [MENU] button → “CAMERA CONTROL” → select the menu item shown below, and press the [VALUE] knob.

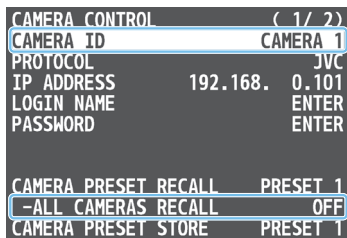

### Recalling presets from a single camera

Menu item	Explanation
CAMERA ID	Select the camera from which you want to recall a preset.
ALL CAMERAS RECALL	Choose “OFF”

### Recalling from all cameras simultaneously

Menu item	Explanation
ALL CAMERAS RECALL	Choose “ON.”

2. Use the [VALUE] knob to change the value of the setting, and press the [VALUE] knob.
3. Use the [VALUE] knob to select “CAMERA PRESET RECALL,” and press the [VALUE] knob.

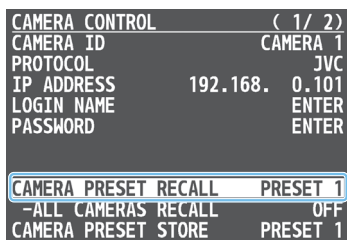

4. Use the [VALUE] knob to select the preset number (PRESET 1–10) that you want to recall, and press the [VALUE] knob.

A confirmation message appears.



\* If you decide to cancel, press the [EXIT] button.

5. Use the [VALUE] knob to select “YES,” and press the [VALUE] knob.

The settings are recalled from the cameras. When the operation is finished, the message “COMPLETE” appears.

6. Press the [MENU] button to close the menu.

## Recalling presets with the buttons

By assigning a USER button to the camera control function, you can recall presets using the button.

In this example, we’ll explain how to use the USER [4] button to recall presets.

\* The camera control function is assigned to the USER [4] button by factory default.

1. From the [MENU] button → “CAMERA CONTROL,” set “ALL CAMERAS RECALL” to “ON” (all cameras) or “OFF” (single camera only).
2. Following the steps in “Assigning Functions to the USER Buttons” (p. 65), assign the “CAMERA CONTROL” function to the USER [4] button.
3. Press the USER [4] button to turn the camera control function on (lit).

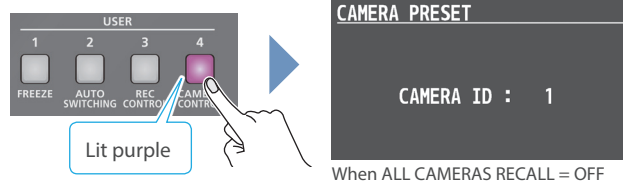

4. If this is set to “OFF” in step 1, change the value to “CAMERA ID” with the [VALUE] knob, and select the camera (1–16) from which to recall the presets.
5. Press the CAMERA PRESET button for the preset number whose setting you want to recall.

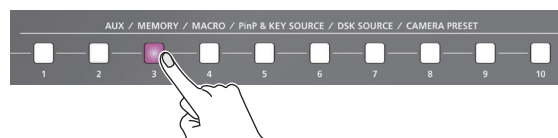

The settings are recalled from the cameras.

6. To turn the camera control function off, press the USER [4] button once again.

## Using a Footswitch

You can use a footswitch connected to the CTL/EXP 1 and 2 jacks to control the V-160HD with your foot. You can assign various functions to the footswitch.

1. [MENU] button → “CTL/EXP” → “CTL/EXP 1” or “CTL/EXP 2” → select “CTL/EXP TYPE,” and press the [VALUE] knob.

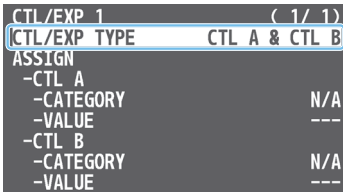

2. Set the connected device to “CTL A & CTL B” (the footswitch) using the [VALUE] knob, and press the [VALUE] knob.
3. Use the [VALUE] knob to select CTL A or CTL B “CATEGORY” and “VALUE,” and press the [VALUE] knob.
4. Use the [VALUE] knob to select the function that you want to assign to CTL A or CTL B of the footswitch, and press the [VALUE] knob.

### ●CATEGORY

Value	Explanation
N/A	No function is assigned.
PGM CH SELECT	Switches the PGM/A cross-point buttons.
PST CH SELECT	Switches the PST/B cross-point buttons.
AUX CH SELECT	Switches the video sent to the AUX bus.
INPUT 1–10 ASSIGN	Changes the video assigned to INPUT 1–10.
STILL OUTPUT	Pauses the normal output, and previews or final outputs a cut of the still image.
PinP & KEY 1–4 SOURCE	Switches the video source of the inset screen.
DSK 1, 2 SOURCE	Switches the DSK video source.
SW CONTROL	This works the same as when you press the button selected in “VALUE.”
TAKE	Switches the video between PGM/A bus and PST/B bus.
AUDIO INPUT MUTE	Turns the mute function on/off for the input audio.
AUDIO OUTPUT MUTE	Turns the mute function on/off for the output audio.
AUDIO INPUT SOLO	Turns the solo function on/off for the input audio.
VOICE CHANGER SW	Turns the voice changer on/off.
REVERB (MOMENTARY)	Reverb turns on only while you press the footswitch.
REVERB (ALTERNATE)	Turns reverb on/off.
OUTPUT FADE	The final output video fades out to a black screen.
LOAD MEMORY	Recalls a preset memory.
INPUT SCAN	Each time you press the footswitch, the INPUT 1–10 video changes in order.
MEMORY SCAN	Each time you press the footswitch, preset memories 1–30 are recalled in order.
MACRO EXECUTE	Executes a macro (a series of recorded operations).
SEQUENCER	When the sequencer function is on, this works the same as when you press the button selected in “VALUE.”
GPO (ONE SHOT)	Outputs a control signal for 0.5 seconds.
GPO (ALTERNATE)	The control signal output is switched on/off with each press of the footswitch.

### ●VALUE

Configures the detailed settings related to “CATEGORY.”

5. Press the [MENU] button to close the menu.

### MEMO

- See “Connecting a Footswitch” (p. 9) for how to connect a footswitch to this unit.
- If a single-pedal type footswitch such as the BOSS FS-5U is connected using a phone cable (mono), the function assigned by “CTL B” is enabled.

## Using an Expression Pedal

You can use an expression pedal connected to the CTL/EXP 1 and 2 jacks to control the V-160HD with your foot.

### Adjusting the Pedal (Pedal Calibration)

The first time you use an expression pedal, you must calibrate (adjust) the pedal so that it will operate optimally.

In some cases, an expression pedal might no longer operate optimally due to the passage of time or changes in the operating conditions. If you notice problems such as slight movements of the pedal causing a major change in volume, or if the video fails to switch when you press the pedal, you should execute calibration.

1. [MENU] button → “CTL/EXP” → “CTL/EXP 1” or “CTL/EXP 2” → select “CTL/EXP TYPE,” and press the [VALUE] knob.

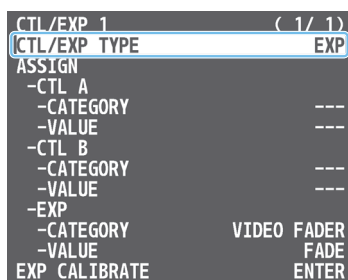

2. Set the connected device to “EXP” (the expression pedal) using the [VALUE] knob, and press the [VALUE] knob.
3. Use the [VALUE] knob to select “EXP CALIBRATE,” and press the [VALUE] knob.

EXP CALIBRATE screen appears.

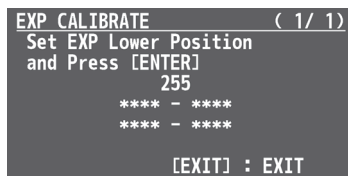

4. As directed by the screen, step on the pedal in the fully heel-down position, and press the [VALUE] knob.
5. As directed by the screen, step on the pedal in the fully toe-down position, and press the [VALUE] knob.  
When the “COMPLETE” indication appears, calibration is completed.
6. Press the [MENU] button to close the menu.

#### MEMO

You should normally use the EV-5 with its minimum volume knob left in the zero position. If you change the position of the minimum volume knob, you must execute pedal calibration.

### Assigning a Function to the Pedal

You can assign various functions to the expression pedal.

1. [MENU] button → “CTL/EXP” → “CTL/EXP 1” or “CTL/EXP 2” → select “CTL/EXP TYPE,” and press the [VALUE] knob.

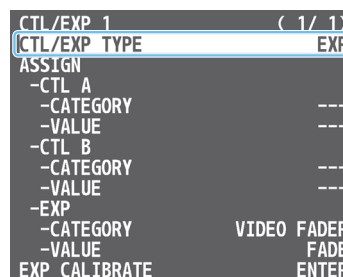

2. Set the connected device to “EXP” (the expression pedal) using the [VALUE] knob, and press the [VALUE] knob.
3. Use the [VALUE] knob to select EXP “CATEGORY” and “VALUE,” and press the [VALUE] knob.
4. Use the [VALUE] knob to select the function that you want to assign to the expression pedal, and press the [VALUE] knob.

#### ●CATEGORY

Value	Explanation
N/A	No function is assigned.
VIDEO FADER	FADE: Operates the video fader. ▲CUT▼: Switches the video between PGM/A bus and PST/B bus as a cut.
STILL OUTPUT	Pauses the normal output, and previews or final outputs a cut of the still image.
AUDIO INPUT LEVEL	Adjusts the input volume.
AUDIO OUTPUT LEVEL	Adjusts the output volume.
VOICE CHANGER MIX	Adjusts the balance between the unprocessed voice (0) and the voice processed by the effect (100).
REVERB LEVEL	Adjusts the amount of sound that is returned from the reverb (return level).

#### ●VALUE

Configures the detailed settings related to “CATEGORY.”

5. Press the [MENU] button to close the menu.

## Control Using the TALLY/GPIO Connector

You can use control signals inputted to the TALLY/GPIO connector via GPI to remotely control the V-160HD from an external device. Also, you can output tally signals or GPO control signals from the TALLY/GPIO connector.

### Specification of the TALLY/GPIO Connector

#### Pin layout

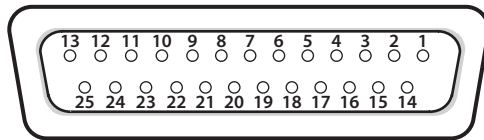

DB-25 type (female)

#### Tally output

Trigger method	Open collector
Maximum input	12 V/120 mA

#### Control input

Trigger method	No-voltage contact (make-contact) triggering
Contact capacity	DC 24 V 0.1 A or higher
Input method	Photocoupler

#### Pin assignments

Pin no.	Pin name	Function (default value)
1	TALLY/GPO 1	PGM HDMI 1
2	TALLY/GPO 2	PST HDMI 1
3	TALLY/GPO 3	PGM HDMI 2
4	TALLY/GPO 4	PST HDMI 2
5	TALLY/GPO 5	PGM HDMI 3
6	TALLY/GPO 6	PST HDMI 3
7	TALLY/GPO 7	PGM HDMI 4
8	TALLY/GPO 8	PST HDMI 4
9	TALLY/GPO 9	PGM HDMI 5
10	TALLY/GPO 10	PST HDMI 5
11	TALLY/GPO 11	PGM HDMI 6
12	TALLY/GPO 12	PST HDMI 6
13	TALLY/GPO 13	PGM HDMI 7
14	TALLY/GPO 14	PST HDMI 7
15	TALLY/GPO 15	PGM HDMI 8
16	TALLY/GPO 16	PST HDMI 8
17	GND	
18	GPI 1	Not assigned
19	GPI 2	Not assigned
20	GPI 3	Not assigned
21	GPI 4	Not assigned
22	GPI 5	Not assigned
23	GPI 6	Not assigned
24	GPI 7	Not assigned
25	GPI 8	Not assigned

### Inputting a Control Signal

When an external control signal is input, the functions assigned to GPI 1–8 are executed.

1. [MENU] button → “RS-232/TALLY/GPO/GPI” → “GPI” → select GPI 1–8 “CATEGORY” and “VALUE,” and press the [VALUE] knob.

GPI ( 1 / 2 )		GPI ( 2 / 2 )	
GPI 1		GPI 5	
-CATEGORY	N/A	-CATEGORY	N/A
-VALUE	---	-VALUE	---
GPI 2		GPI 6	
-CATEGORY	N/A	-CATEGORY	N/A
-VALUE	---	-VALUE	---
GPI 3		GPI 7	
-CATEGORY	N/A	-CATEGORY	N/A
-VALUE	---	-VALUE	---
GPI 4		GPI 8	
-CATEGORY	N/A	-CATEGORY	N/A
-VALUE	---	-VALUE	---

2. Use the [VALUE] knob to select the functions assigned to GPI 1–8, and then press [VALUE].

#### ●CATEGORY

Value	Explanation
N/A	No function is assigned.
PGM CH SELECT	Switches the PGM/A cross-point buttons.
PST CH SELECT	Switches the PST/B cross-point buttons.
AUX CH SELECT	Switches the video sent to the AUX bus.
INPUT 1–10 ASSIGN	Changes the video assigned to INPUT 1–10.
STILL OUTPUT	Pauses the normal output, and previews or final outputs a cut of the still image.
PinP & KEY 1–4 SOURCE	Switches the video source of the inset screen.
DSK 1, 2 SOURCE	Switches the DSK video source.
SW CONTROL	This works the same as when you press the button selected in “VALUE.”
TAKE	Switches the video between PGM/A bus and PST/B bus.
AUDIO INPUT MUTE	Turns the mute function on/off for the input audio.
AUDIO OUTPUT MUTE	Turns the mute function on/off for the output audio.
AUDIO INPUT SOLO	Turns the solo function on/off for the input audio.
VOICE CHANGER SW	Turns the voice changer on/off.
REVERB (MOMENTARY)	Reverb turns on only while a control signal is input.
REVERB (ALTERNATE)	Turns reverb on/off.
OUTPUT FADE	The final output video fades out to a black screen.
LOAD MEMORY	Recalls a preset memory.
INPUT SCAN	Each time a control signal is input, the INPUT 1–10 video changes in order.
MEMORY SCAN	Each time a control signal is input preset memories 1–30 are recalled in order.
MACRO EXECUTE	Executes a macro (a series of recorded operations).
SEQUENCER	When the sequencer function is on, this works the same as when you press the button selected in “VALUE.”
GPO (ONE SHOT)	Outputs a control signal for 0.5 seconds.
GPO (ALTERNATE)	The control signal output is switched on/off each time a control signal is input.

#### ●VALUE

Configures the detailed settings related to “CATEGORY.”

3. Press the [MENU] button to close the menu.

## Outputting a Tally Signal

Pins 1–16 of the TALLY/GPIO connector can be used to output a tally. A tally signal is output from the connector pins whenever a cross-point button is selected.

1. [MENU] button → “RS-232/TALLY/GPIO/GPI” → “TALLY/GPIO” → select “TALLY/GPIO 1”–“TALLY/GPIO 16,” and press the [VALUE] knob.

TALLY/GPIO ( 1 / 2 )		TALLY/GPIO ( 2 / 2 )	
TEMPLATE	HDMI TALLY	TALLY/GPIO 11	PGM HDMI 6
TALLY/GPIO 1	PGM HDMI 1	TALLY/GPIO 12	PST HDMI 6
TALLY/GPIO 2	PST HDMI 1	TALLY/GPIO 13	PGM HDMI 7
TALLY/GPIO 3	PGM HDMI 2	TALLY/GPIO 14	PST HDMI 7
TALLY/GPIO 4	PST HDMI 2	TALLY/GPIO 15	PGM HDMI 8
TALLY/GPIO 5	PGM HDMI 3	TALLY/GPIO 16	PST HDMI 8
TALLY/GPIO 6	PST HDMI 3		
TALLY/GPIO 7	PGM HDMI 4		
TALLY/GPIO 8	PST HDMI 4		
TALLY/GPIO 9	PGM HDMI 5		
TALLY/GPIO 10	PST HDMI 5		

2. Use the [VALUE] knob to select the tally signal assigned to the connector pins and then press the [VALUE] knob.

Value	Explanation
PGM HDMI 1–8	Final output selection is HDMI IN 1–8
PGM SDI 1–8	Final output selection is SDI IN 1–8
PST HDMI 1–8	Preview output selection is HDMI IN 1–8
PST SDI 1–8	Preview output selection is SDI IN 1–8

3. Press the [MENU] button to close the menu.

### MEMO

Use a settings template to change the assignments for the connector pins all at once.

Select a template from “TEMPLATE” in the TALLY/GPIO menu and then press the [VALUE] knob to apply the settings.

## Outputting a Control Signal

You can use connector pins 1–16 of the TALLY/GPIO connector as GPOs to output control signals.

### Assigning the GPOs

You can assign pins 1–16 of the TALLY/GPIO connector to the GPOs (1–16) in order to output control signals.

1. [MENU] button → “RS-232/TALLY/GPIO/GPI” → “TALLY/GPIO” → select “TALLY/GPIO 1”–“TALLY/GPIO 16,” and press the [VALUE] knob.

TALLY/GPIO ( 1 / 2 )		TALLY/GPIO ( 2 / 2 )	
TEMPLATE	HDMI TALLY	TALLY/GPIO 11	PGM HDMI 6
TALLY/GPIO 1	PGM HDMI 1	TALLY/GPIO 12	PST HDMI 6
TALLY/GPIO 2	PST HDMI 1	TALLY/GPIO 13	PGM HDMI 7
TALLY/GPIO 3	PGM HDMI 2	TALLY/GPIO 14	PST HDMI 7
TALLY/GPIO 4	PST HDMI 2	TALLY/GPIO 15	PGM HDMI 8
TALLY/GPIO 5	PGM HDMI 3	TALLY/GPIO 16	PST HDMI 8
TALLY/GPIO 6	PST HDMI 3		
TALLY/GPIO 7	PGM HDMI 4		
TALLY/GPIO 8	PST HDMI 4		
TALLY/GPIO 9	PGM HDMI 5		
TALLY/GPIO 10	PST HDMI 5		

2. Use the [VALUE] knob to select one of “GPO 1”–“GPO 16,” and press the [VALUE] knob.
3. Press the [MENU] button to close the menu.

### MEMO

Use a settings template to change the assignments for the connector pins all at once.

Select a template from “TEMPLATE” in the TALLY/GPIO menu and then press the [VALUE] knob to apply the settings.

## Outputting a control signal

Control signals are outputted when you operate a USER button, footswitch or other control to which a GPO output function has been assigned.

### Using the USER buttons

The USER buttons light up while control signals are being output.

➔ “Assigning Functions to the USER Buttons” (p. 65)

### Using a footswitch

➔ “Using a Footswitch” (p. 68)

### Inputting an external control signal (GPI)

➔ “Inputting a Control Signal” (p. 70)

## Using Smart Tally

Roland's own Smart Tally system turns your smart device or computer that's connected to the V-160HD into a tally box. This lets you access your smart device or computer via a wireless LAN access point to display a tally on that device.

### Connecting via a Wireless LAN Router

Connect your Wi-Fi enabled smart device or computer to the wireless LAN router via Wi-Fi.

\* If you connect multiple smart devices or computers, operation might be slower.

1. Use a LAN cable to connect the LAN port on your wireless LAN master device to the LAN CONTROL port on the V-160HD.

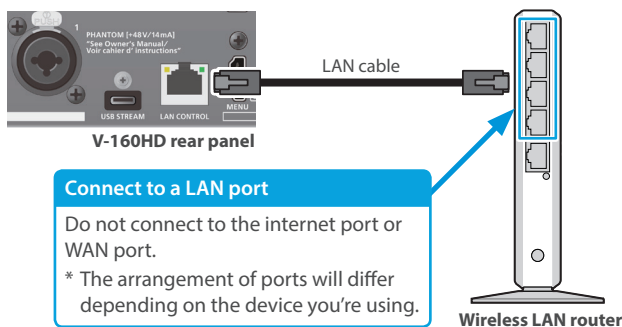

2. Turn on the wireless LAN master device, and connect your smart device or computer via wireless LAN (Wi-Fi).

Enable the DHCP function of the wireless LAN router.

\* For details on how to connect the wireless LAN (Wi-Fi), refer to the manual of the device that you're using.

3. Power-on the V-160HD.

4. [MENU] button → "LAN CONTROL" → set "CONFIGURE" to "USING DHCP," and press the [VALUE] knob.

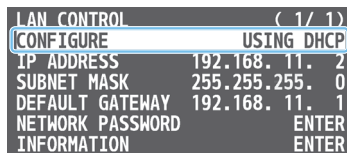

The IP address, subnet mask, and default gateway are obtained automatically.

5. Use the [VALUE] knob to select "INFORMATION," and press the [VALUE] knob.

The LAN INFORMATION screen appears.

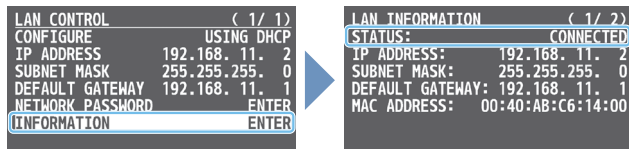

When "STATUS" indicates "CONNECTED," the connection settings are complete.

#### MEMO

If you fix the IP address, you'll always be able to start Smart Tally with the same IP address.

For details on how to specify a fixed IP address, refer to the manual of the wireless LAN router that you're using.

### Starting Smart Tally

1. From the V-160HD's [MENU] button → "LAN CONTROL" → select "INFORMATION," and press the [VALUE] knob.

The LAN INFORMATION screen appears.

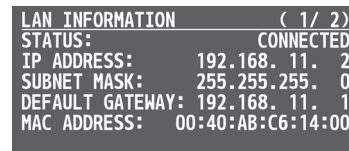

2. Start a browser on your smart device or computer.

3. In the URL input field of your browser, enter the IP address that's shown in the LAN INFORMATION screen to access the website.

The Smart Tally settings screen appears.

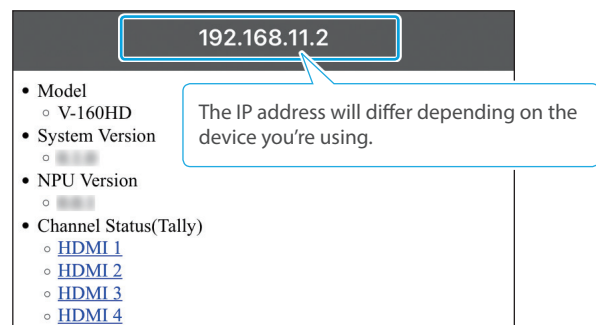

- You can also access the website by scanning a QR code. Turn the [VALUE] knob clockwise at the screen in step 1 to display the QR code.

4. In "Channel Status(Tally)," select the video source that you want to assign to the smart device or computer.

The device's display switches to the tally information screen.

This shows the tally information corresponding to the video source output from the V-160HD.



#### NOTE

- Depending on the network conditions, the wireless LAN (Wi-Fi) communication speed or connection might be unstable, so that the tally indication is not displayed correctly. In this case, reload the page.
- Depending on the version of the browser that you're using, the tally indication might not be displayed correctly. Use the latest version of the browser whenever possible.



## Preventing Unintended Operation (Panel Lock)

You can disable operation of the panel's buttons and knobs to prevent unintended operations (Panel Lock function).

1. [MENU] button → "SYSTEM" → select "PANEL LOCK," and press the [VALUE] knob.

The PANEL LOCK menu appears.

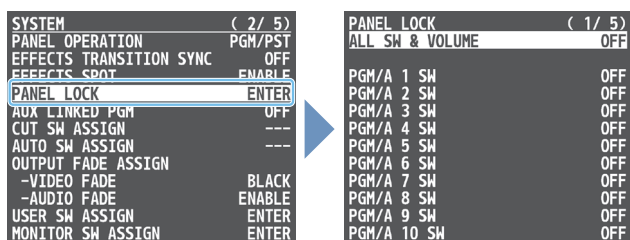

2. Use the [VALUE] knob to select a target for panel lock, and press the [VALUE] knob.

Menu item	Explanation
ALL SW & VOLUME	The following settings are turned on/off together.
PGM/A 1–10 SW	PGM/A cross-point [1]–[10] buttons
PST/B 1–10 SW	PST/B cross-point [1]–[10] buttons
INPUT ASSIGN SW	[INPUT ASSIGN] button
CUT SW	[CUT] button
AUTO SW	[AUTO] button
MODE SW	[MODE] button
AUX SW	AUX [1]–[10] buttons
MEMORY SW	MEMORY [1]–[10] buttons
MACRO SW	MACRO [1]–[10] buttons
TRANSITION SW	[TRANSITION] button
VIDEO FADER	Video fader
SPLIT BLOCK	[SPLIT 1] [SPLIT 2] buttons [PGM/A-CENTER] [PST/B-CENTER] knobs
SEQUENCER BLOCK	Buttons in the SEQUENCER section
PinP & KEY 1–4 BLOCK	Buttons and knobs in the PinP & KEY sections
DSK 1, 2 BLOCK	Buttons and knobs in the DSK sections
MONITOR 1–4 SW	MONITOR [1]–[4] buttons
OUTPUT FADE SW	[OUTPUT FADE] button
CAPTURE IMAGE SW	[CAPTURE IMAGE] button
USER 1–4 SW	USER [1]–[4] buttons
AUDIO IN 1–3/4 VOLUME	AUDIO INPUT LEVEL [1] [2] [3/4] knob
AUTO MIXING SW	[AUTO MIXING] button
AUX VOLUME	[AUX] knob
USB STREAM VOLUME	[USB STREAM] knob
MASTER OUTPUT VOLUME	[MASTER OUTPUT] knob

3. Use the [VALUE] knob to specify whether panel lock is enable (ON) or disable (OFF), and press the [VALUE] knob.
4. Press the [MENU] button to close the menu.

### MEMO

The [MENU] button blinks when you try to operate a locked button, knob or other control.

## Returning to the Factory Settings (Factory Reset)

Here's how you can return the settings of the V-160HD to their factory-set state.

If following the procedures described in this manual does not cause the result you expect, try executing a factory reset.

### NOTE

- When you execute a factory reset, all the settings you've made as well as the data saved on the V-160HD (preset memory, macros, sequencer, and still images) is lost.
- Do not turn off the power while the message "PLEASE WAIT" is shown.

1. [MENU] button → "SYSTEM" → select "FACTORY RESET," and press the [VALUE] knob.

A confirmation message appears.

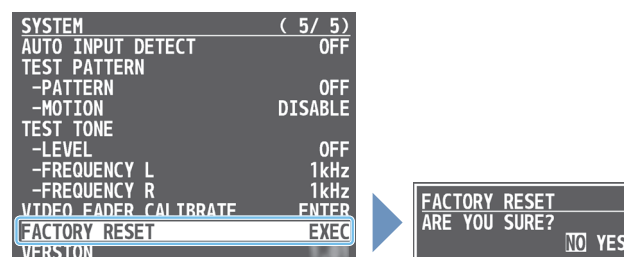

\* If you decide to cancel, press the [EXIT] button.

2. Use the [VALUE] knob to select "YES," and press the [VALUE] knob.

Factory reset is executed. When the operation is finished, the message "COMPLETE" appears.

3. Press the [MENU] button to close the menu.

## Remotely Controlling the V-160HD

To remotely control the V-160HD, you can use an external device to send control signals to the unit (p. 70), use a dedicated app, or use LAN/RS-232 commands.

### Using the dedicated apps “V-160HD RCS” and “V-160HD Remote”

Dedicated apps are available for computers (“V-160HD RCS”) and for the iPad (“V-160HD Remote”).

These apps can be downloaded from the Roland website.

<https://proav.roland.com/>

\* For details on operation, refer to the Owner’s Manual of “V-160HD RCS” or “V-160HD Remote.”

#### V-160HD RCS

Use the dedicated “V-160HD RCS” app to operate the V-160HD from your computer.

You can connect either wirelessly or via cable.

##### Wireless connection

- Connection via wireless LAN master device (Wi-Fi)

##### Wired connection (via cable)

- USB connection (USB Type-C cable)
- LAN connection (LAN cable)
- RS-232 connection (RS-232 cable)

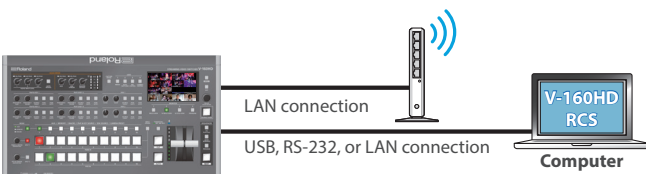

#### V-160HD Remote

Use the dedicated “V-160HD Remote” app to operate the V-160HD from your iPad.

You can connect either wirelessly or via cable.

##### Wireless connection

- Bluetooth connection
- Connection via wireless LAN master device (Wi-Fi)

##### Wired connection (via cable)

USB connection (USB Type-C cable, Lightning to USB camera adapter)

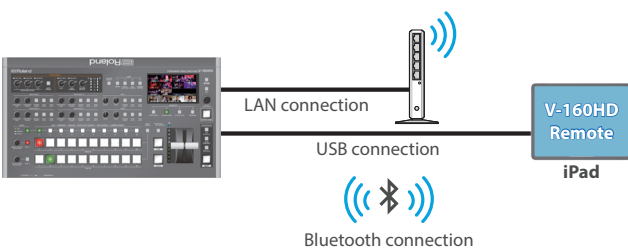

### LAN/RS-232 command

The V-160HD support two types of remote-interface communication: LAN and RS-232.

Using the LAN CONTROL port or RS-232 connector to send specific commands to the V-160HD from a controlling device lets you operate the V-160HD.

See “Remote Control Guide” (PDF) for details on each interface and for a list of LAN/RS-232 commands.

<https://proav.roland.com/manuals/>

#### MEMO

##### MIDI implementation

The V-160HD supports MIDI remote control.

See “MIDI Implementation” in the “Remote Control Guide” (PDF) for details.

# Menu List

## 1: VIDEO ASSIGN

Menu item	Value (bold text: default value)	Explanation
INPUT 1-10	HDMI 1-8, SDI 1-8, STILL 1-16 The default values are as follows. INPUT 1: <b>HDMI 1</b> INPUT 2: <b>HDMI 2</b> INPUT 3: <b>HDMI 3</b> INPUT 4: <b>HDMI 4</b> INPUT 5: <b>HDMI 5</b> INPUT 6: <b>HDMI 6</b> INPUT 7: <b>HDMI 7</b> INPUT 8: <b>HDMI 8</b> INPUT 9: <b>STILL 1</b> INPUT 10: <b>STILL 2</b>	Sets the video source (input video and still images) to assign to the cross-point [1]-[10] buttons.
HDMI OUT 1-3	Specifies the video bus that is assigned to the HDMI OUT 1-3 connectors. * When you change the settings assigned to "HDMI OUT 3," the display on the monitor of this unit changes as well.	
	<b>PROGRAM</b>	Final output video. This is the default setting for "HDMI OUT 1."
	SUB PROGRAM	SUB PROGRAM bus video
	<b>PREVIEW</b>	Preview output video. This is the default setting for "HDMI OUT 2."
	AUX	AUX bus video
	<b>MULTI-VIEW</b>	Multi-view. This is the default setting for "HDMI OUT 3."
	16 INPUT-VIEW	The input video from the HDMI IN and SDI IN connectors (shown as 16 separate sections on the screen)
16 STILL-VIEW	Still images loaded into the unit (shown as 16 separate sections on the screen)	
SDI OUT 1-3	Specifies the video bus that is assigned to the SDI OUT 1-3 connectors.	
	<b>PROGRAM</b>	Final output video. This is the default setting for "SDI OUT 1."
	SUB PROGRAM	SUB PROGRAM bus video
	<b>PREVIEW</b>	Preview output video. This is the default setting for "SDI OUT 2."
	AUX	AUX bus video
	<b>MULTI-VIEW</b>	Multi-view. This is the default setting for "SDI OUT 3."
	16 INPUT-VIEW	The input video from the HDMI IN and SDI IN connectors (shown as 16 separate sections on the screen)
16 STILL-VIEW	Still images loaded into the unit (shown as 16 separate sections on the screen)	
USB OUT	Specifies the video bus that is assigned to the USB STREAM port.	
	<b>PROGRAM</b>	Final output video.
	SUB PROGRAM	SUB PROGRAM bus video
	PREVIEW	Preview output video.
	AUX	AUX bus video
	MULTI-VIEW	Multi-view.
	16 INPUT-VIEW	The input video from the HDMI IN and SDI IN connectors (shown as 16 separate sections on the screen)
16 STILL-VIEW	Still images loaded into the unit (shown as 16 separate sections on the screen)	
AUX SOURCE	<b>HDMI 1-8</b> , SDI 1-8, STILL 1-16	Selects the video that is sent to the AUX bus. When "AUX" is selected on the [MODE] button, you can use the AUX [1]-[10] buttons to select the video that is sent to the AUX bus.
PROGRAM LAYER	ENTER	
	Displays the PROGRAM LAYER menu.	
	<b>Menu item</b>	<b>Value</b>
PinP & KEY 1-4	DISABLE, <b>ENABLE</b>	Sets whether each layer is displayed (ENABLE) or hidden (DISABLE) in the final output video.
DSK 1, 2	DISABLE, <b>ENABLE</b>	
SUB PROGRAM LAYER	ENTER	
	Displays the SUB PROGRAM LAYER menu.	
	<b>Menu item</b>	<b>Value</b>
PinP & KEY 1-4	DISABLE, <b>ENABLE</b>	Sets whether each layer is displayed (ENABLE) or hidden (DISABLE) in the SUB PROGRAM bus video.
DSK 1, 2	DISABLE, <b>ENABLE</b>	

## 2: VIDEO INPUT

Menu item	Value (bold text: default value)	Explanation
<b>HDMI IN 1–4</b> Adjusts the video that is input from the HDMI IN 1–4 connectors.		
INPUT STATUS	ENTER	Displays information about the incoming video (format, size, etc.).
FLIP H	<b>OFF</b> , ON	When this is "ON," the video is input with left and right flipped.
FLIP V	<b>OFF</b> , ON	When this is "ON," the video is input with top and bottom flipped.
BRIGHTNESS	-32- <b>0</b> -31	Adjusts the brightness.
CONTRAST	-32- <b>0</b> -31	Adjusts the contrast.
SATURATION	-32- <b>0</b> -31	Adjusts the saturation.
<b>HDMI IN 5–8 (SCALER)</b> Adjusts the video that is input from the HDMI IN 5–8 connectors.		
INPUT STATUS	ENTER	Displays information about the incoming video (format, size, etc.).
FLICKER FILTER	<b>OFF</b> , ON	When this is "ON," flickering is reduced.
FLIP H	<b>OFF</b> , ON	When this is "ON," the video is input with left and right flipped.
FLIP V	<b>OFF</b> , ON	When this is "ON," the video is input with top and bottom flipped.
EDID (*1)	<b>INTERNAL</b> SVGA (800 x 600) XGA (1024 x 768) WXGA (1280 x 800) FWXGA (1366 x 768) SXGA (1280 x 1024) SXGA+ (1400 x 1050) UXGA (1600 x 1200) WUXGA (1920 x 1200) 720p, 1080i, 1080p	Specifies the input format (EDID). When this is "INTERNAL," EDID information for all formats that can be input to the V-160HD will be transmitted.  <b>What is EDID?</b> EDID is data that is transmitted from the V-160HD to the source device when the V-160HD is connected to a source device. EDID contains data such as the formats that can be input to the V-160HD (resolution, color space, color depth) and audio information. Based on the EDID information that the source device receives, it will output the most appropriate video format to the V-160HD.
ZOOM	10.0- <b>100.0</b> -1000.0% (*2)	Adjusts the zoom ratio.
SCALING TYPE	Specifies the scaling type.	
	<b>FULL</b>	Always displays the picture expanded to full screen, irrespective of the aspect ratio of the input video.
	LETTERBOX	Enlarges or reduces the incoming video to a full-screen view while keeping the aspect ratio unchanged.
	CROP	Enlarges or reduces the incoming video so that the output picture has no blank margins while keeping the aspect ratio unchanged. Video extending beyond the borders is cut off.
	DOT BY DOT	Performs no scaling.
	MANUAL	Scale according to the "MANUAL SIZE H" and "MANUAL SIZE V" settings below.
MANUAL SIZE H (*3)	-2000- <b>0</b> -2000 (*2)	Adjusts the horizontal size.
MANUAL SIZE V (*3)	-2000- <b>0</b> -2000 (*2)	Adjusts the vertical size.
POSITION H	-1920- <b>0</b> -1920	Adjusts the position in the horizontal direction.
POSITION V	-1200- <b>0</b> -1200	Adjusts the position in the vertical direction.
BRIGHTNESS	-32- <b>0</b> -31	Adjusts the brightness.
CONTRAST	-32- <b>0</b> -31	Adjusts the contrast.
SATURATION	-32- <b>0</b> -31	Adjusts the saturation.
RED	-64- <b>0</b> -63	Adjusts the red level.
GREEN	-64- <b>0</b> -63	Adjusts the green level.
BLUE	-64- <b>0</b> -63	Adjusts the blue level.
<b>SDI IN 1–8</b> Adjusts the video that is input from the SDI IN 1–8 connectors.		
INPUT STATUS	ENTER	Adjusts the brightness.
FLIP H	<b>OFF</b> , ON	Adjusts the contrast.
FLIP V	<b>OFF</b> , ON	Adjusts the saturation.
BRIGHTNESS	-32- <b>0</b> -31	Adjusts the red level.
CONTRAST	-32- <b>0</b> -31	Adjusts the green level.
SATURATION	-32- <b>0</b> -31	Adjusts the blue level.

(\*1) A change in the setting is not applied until you press the [VALUE] knob to confirm.

(\*2) The valid range of setting values depends on conditions such as the input/output format.

(\*3) This can be set if "SCALING TYPE" is "MANUAL."



## 3: VIDEO OUTPUT

Menu item	Value (bold text: default value)	Explanation
<b>HDMI OUT 1-3</b> Adjusts the video that is output from the HDMI OUT 1-3 connectors.		
OUTPUT STATUS	—	Shows the format and an HDCP signal presence. If there is no connection, "NOT CONNECTED" is shown.
COLOR SPACE	<b>YPbPr (4: 4: 4)</b> , YPbPr (4: 2: 2), RGB (0-255), RGB (16-235)	Specifies the color space.
DVI-D/HDMI SIGNAL	<b>HDMI</b> , DVI-D	Specifies the type of output signal.
BRIGHTNESS	-64- <b>0</b> -63	Adjusts the brightness.
CONTRAST	-64- <b>0</b> -63	Adjusts the contrast.
SATURATION	-64- <b>0</b> -63	Adjusts the saturation.
RED	-64- <b>0</b> -63	Adjusts the red level.
GREEN	-64- <b>0</b> -63	Adjusts the green level.
BLUE	-64- <b>0</b> -63	Adjusts the blue level.
REC CONTROL	OFF, <b>ON</b>	Turns the REC control on/off. When this is "ON," REC START/STOP commands can be sent to a recorder that supports REC control functionality. To use the REC control function, the REC START/STOP functions must be assigned to the USER button. From the SYSTEM menu → "USER SW ASSIGN" → "USER 1 SW"-"USER 4 SW," set "CATEGORY" to "REC CONTROL."
<b>SDI OUT 1-3</b> Adjusts the video that is output from the SDI OUT 1-3 connectors.		
OUTPUT STATUS	—	Shows the format. * When "HDCP" in the SYSTEM menu is "ON," "HDCP MASKED" is displayed, and video/audio is not outputted from the SDI OUT connectors.
3G-SDI MAPPING	LEVEL-A, <b>LEVEL-B</b>	Specifies the mapping structure of the 3G-SDI output.
BRIGHTNESS	-64- <b>0</b> -63	Adjusts the brightness.
CONTRAST	-64- <b>0</b> -63	Adjusts the contrast.
SATURATION	-64- <b>0</b> -63	Adjusts the saturation.
<b>USB OUT</b> Adjusts the video that is output from the USB STREAM port. * You can edit the USB output video format and compression method from the livestreaming app or other app used at the output destination.		
OUTPUT STATUS	—	Indicates whether the connection uses USB 2.0 (HIGH SPEED) or USB 3.0 (SUPER SPEED). If not connected to a computer, this indicates "NOT CONNECTED." * When "HDCP" in the SYSTEM menu is "ON," "HDCP MASKED" is displayed, and video/audio is not outputted from the USB STREAM port.
CONNECTION RESET	EXEC	Reconnects the computer and the V-160HD when the video is garbled or when operation is otherwise unstable.



## 4: TRANSITION TIME

Menu item	Value (bold text: default value)	Explanation
MIX/WIPE TIME	0.0- <b>1.0</b> -4.0sec	Specifies the video transition time.
PinP & KEY 1- 4 TIME	0.0- <b>1.0</b> -4.0sec	For PinP compositing, specifies the fade-in/out time for the inset screen.
DSK 1, 2 TIME	0.0- <b>1.0</b> -4.0sec	For DSK compositing, specifies the fade-in/out time for the overlay caption or video.
OUTPUT FADE TIME	0.0- <b>1.0</b> -4.0sec	Sets the time it takes for the video and audio to fade in/out when you press the [OUTPUT FADE] button.

## 5: MIX/WIPE

Menu item	Value (bold text: default value)	Explanation
TRANSITION TYPE	Selects the transition effect. You can also use the [TRANSITION] button to switch between MIX and WIPE.	
	<b>MIX</b>	The two videos are mixed as the transition occurs. 
	WIPE	The next video moves across to replace the original video. 
MIX TYPE	Specifies the transition pattern for mix.	
	<b>MIX</b>	The two videos are mixed as the transition occurs.
	FAM	Video transitions are made with the luminance levels of the two video streams maintained unchanged. This is an abbreviation of "full additive mix."
	NAM	The two video streams are compared, and transitions are made with display during transition starting with levels of high luminance. This is an abbreviation of "non-additive mix."
WIPE TYPE	Specifies the transition pattern for wipe.	
	<b>HORIZONTAL</b> VERTICAL   UPPER LEFT   UPPER RIGHT   LOWER LEFT   LOWER RIGHT   H-CENTER   V-CENTER 	
WIPE DIRECTION	<b>NORMAL</b> , REVERSE, ROUND TRIP	Specifies the direction of wipe.
WIPE BORDER COLOR	<b>WHITE</b> , YELLOW, CYAN, GREEN, MAGENTA, RED, BLUE, BLACK, SOFT EDGE	Specifies the color of the border added to the edge of the wipe area. When this is set to "SOFT EDGE," the wipe border is blurred.
WIPE BORDER WIDTH	0- <b>3</b> -14	Specifies the width of the border added to the edge of the wipe area.

## 6: SPLIT

Menu item	Value (bold text: default value)	Explanation
<b>SPLIT 1, 2</b>	These are the detailed settings for the split composite.	
SPLIT	<b>OFF</b> , ON	Turns the split composition on/off. You can also use the [SPLIT 1] or [SPLIT 2] button to turn this on/off.
SPLIT TYPE	These parameters configure the split screen layout.	
	<b>SPLIT V</b> 	This vertically crops the center section of the video (split left/right).
	<b>SPLIT H</b> 	This horizontally crops the center section of the video (split upper/lower).
PGM/A-CENTER	-50.0- <b>0.0</b> -50.0%	<b>When at SPLIT V</b> Adjusts the horizontal position of the video placed on the left. You can also adjust this by turning the [PGM/A-CENTER] knob.  <b>When at SPLIT H</b> Adjusts the horizontal position of the video placed above. You can also adjust this by turning the [PST/B-CENTER] knob. * This positions the PGM/A bus video to the left or upper side.
PST/B-CENTER	-50.0- <b>0.0</b> -50.0%	<b>When at SPLIT V</b> Adjusts the horizontal position of the video placed on the right. You can also adjust this by turning the [PGM/A-CENTER] knob.  <b>When at SPLIT H</b> Adjusts the horizontal position of the video placed below. You can also adjust this by turning the [PST/B-CENTER] knob. * This positions the PST/B bus video to the right or lower side.
CENTER POSITION	-50.0- <b>0.0</b> -50.0%	Adjusts the position of the boundary. You can adjust this by turning the [PGM/A-CENTER] or [PST/B-CENTER] knob while pressing it.
BORDER COLOR	<b>WHITE</b> , YELLOW, CYAN, GREEN, MAGENTA, RED, BLUE, BLACK	Specifies the color of the border.
BORDER WIDTH	0- <b>3</b> -14	Adjusts the width of the border.

## 7: PinP & KEY

Menu item	Value (bold text: default value)	Explanation
<b>PinP &amp; KEY 1–4</b>	These are the detailed settings for PinP and key composition for each PinP and key layer.	
<b>PinP &amp; KEY SOURCE</b>	HDMI 1–8, SDI 1–8, STILL 1–16	Specifies the video source of the inset screen.
<b>TYPE</b>	Specifies the type of PinP compositing.	
	<b>PinP</b>	Composites the inset screen on top of the background video.
	LUMINANCE-WHITE KEY	A combination of PinP and luminance key (white). Makes the white portions of the inset screen transparent, and composites the image with the background.
	LUMINANCE-BLACK KEY	A combination of PinP and luminance key (black). Makes the black portions of the inset screen transparent, and composites the image with the background.
	CHROMA KEY	A combination of PinP and chroma key. Makes the specified key color portions of the inset screen transparent, and composites the image with the background.
<b>COPY SETTINGS FROM</b>	PinP & KEY 1–4	Specifies the copy source for the PinP and key settings. Press the [VALUE] knob to copy the settings.
<b>SWAP SETTINGS WITH</b>	PinP & KEY 1–4	Specifies the swap destination for the PinP and key settings. Press the [VALUE] knob to swap the settings.
<b>When TYPE = PinP</b>		
<b>WINDOW</b>	Adjusts the inset screen.	
<b>POSITION H</b>	-50.0– <b>-40.0</b> –50.0%	Adjusts the horizontal position of the inset screen. You can also adjust this by turning the [POSITION H] knob.
<b>POSITION V</b>	-50.0– <b>-40.0</b> –50.0%	Adjusts the vertical position of the inset screen. You can also adjust this by turning the [POSITION V] knob.
<b>SIZE</b>	0.0– <b>35.0</b> –100.0%	Adjusts the size of the inset screen. You can adjust this by turning the [POSITION H] knob while pressing it.
<b>CROPPING H</b>	0.0– <b>100.0%</b>	Adjusts the horizontal size of the inset screen.
<b>CROPPING V</b>	0.0– <b>100.0%</b>	Adjusts the vertical size of the inset screen.
<b>SHAPE</b>	<b>RECTANGLE</b> , CIRCLE, DIAMOND	Specifies the shape of the inset screen.
<b>BORDER COLOR</b>	<b>WHITE</b> , YELLOW, CYAN, GREEN, MAGENTA, RED, BLUE, BLACK, SOFT EDGE	Specifies the color of the border for the inset screen. When this is set to "SOFT EDGE," the edge of the inset screen is blurred.
<b>BORDER WIDTH</b>	0– <b>3</b> –14	Adjusts the width of the border for the inset screen.
<b>VIEW</b>	Adjusts the video that is shown in the inset screen.	
<b>POSITION H</b>	-50.0– <b>0.0</b> –50.0%	Adjusts the horizontal position at which the inset screen is shown.
<b>POSITION V</b>	-50.0– <b>0.0</b> –50.0%	Adjusts the vertical position at which the inset screen is shown.
<b>ZOOM</b>	<b>100</b> –400%	Adjusts the zoom of the video shown in the inset screen. You can adjust this by turning the [POSITION V] knob while pressing it.
<b>When TYPE = LUMINANCE-WHITE KEY or LUMINANCE-BLACK KEY</b>		
<b>WINDOW</b>	Adjusts the inset screen.	
<b>POSITION H</b>	-50.0– <b>-40.0</b> –50.0%	Adjusts the horizontal position of the inset screen. You can also adjust this by turning the [POSITION H] knob.
<b>POSITION V</b>	-50.0– <b>-40.0</b> –50.0%	Adjusts the vertical position of the inset screen. You can also adjust this by turning the [POSITION V] knob.
<b>SIZE</b>	0.0– <b>35.0</b> –100.0%	Adjusts the size of the inset screen. You can adjust this by turning the [POSITION H] knob while pressing it.
<b>CROPPING H</b>	0.0– <b>100.0%</b>	Adjusts the horizontal size of the inset screen.
<b>CROPPING V</b>	0.0– <b>100.0%</b>	Adjusts the vertical size of the inset screen.
<b>VIEW</b>	Adjusts the video that is shown in the inset screen.	
<b>POSITION H</b>	-50.0– <b>0.0</b> –50.0%	Adjusts the horizontal position at which the inset screen is shown.
<b>POSITION V</b>	-50.0– <b>0.0</b> –50.0%	Adjusts the vertical position at which the inset screen is shown.
<b>ZOOM</b>	<b>100</b> –400%	Adjusts the zoom of the video shown in the inset screen. You can adjust this by turning the [POSITION V] knob while pressing it.
<b>KEY LEVEL</b>	0– <b>64</b> –255	Adjusts the degree of extraction (transparency) for the key.
<b>KEY GAIN</b>	<b>0</b> –255	Adjusts the degree of edge blur (semi-transmissive region) for the key.
<b>MIX LEVEL</b>	0– <b>255</b>	Adjusts the key's overall density (output level).

## Menu List

Menu item	Value (bold text: default value)	Explanation
<b>When TYPE = CHROMA KEY</b>		
<b>WINDOW</b>	Adjusts the inset screen.	
POSITION H	-50.0– <b>-40.0</b> –50.0%	Adjusts the horizontal position of the inset screen. You can also adjust this by turning the [POSITION H] knob.
POSITION V	-50.0– <b>-40.0</b> –50.0%	Adjusts the vertical position of the inset screen. You can also adjust this by turning the [POSITION V] knob.
SIZE	0.0– <b>35.0</b> –100.0%	Adjusts the size of the inset screen. You can adjust this by turning the [POSITION H] knob while pressing it.
CROPPING H	0.0– <b>100.0%</b>	Adjusts the horizontal size of the inset screen.
CROPPING V	0.0– <b>100.0%</b>	Adjusts the vertical size of the inset screen.
<b>VIEW</b>	Adjusts the video that is shown in the inset screen.	
POSITION H	-50.0– <b>0.0</b> –50.0%	Adjusts the horizontal position at which the inset screen is shown.
POSITION V	-50.0– <b>0.0</b> –50.0%	Adjusts the vertical position at which the inset screen is shown.
ZOOM	<b>100</b> –400%	Adjusts the zoom of the video shown in the inset screen. You can adjust this by turning the [POSITION V] knob while pressing it.
KEY LEVEL	0– <b>64</b> –255	Adjusts the degree of extraction (transparency) for the key.
KEY GAIN	<b>0</b> –255	Adjusts the degree of edge blur (semi-transmissive region) for the key.
MIX LEVEL	0– <b>255</b>	Adjusts the key's overall density (output level).
<b>CHROMA</b>	Make detailed settings for chroma key.	
COLOR	GREEN, <b>BLUE</b>	Specifies green or blue as the key color (the color to be removed). If you want a color other than green or blue to turn transparent, use "SAMPLING MARKER" to specify the key color.
HUE WIDTH	-30– <b>0</b> –30	Adjusts the hue width for the key color.
HUE FINE	0– <b>240</b> –360	Adjusts the center position of the hue for the key color.
SATURATION WIDTH	-128– <b>0</b> –127	Adjusts the saturation width for the key color.
SATURATION FINE	<b>0</b> –255	Adjusts the center position of saturation for the key color.
SAMPLING MARKER	<b>OFF</b> , ON	When this is "ON," a sampling marker (  ) is shown for you to sample (detect) the key color. When you execute sampling, the setting automatically turns "OFF."
POSITION H (*4)	-50– <b>0</b> –50%	Adjusts the horizontal position of the sampling marker.
POSITION V (*4)	-50– <b>0</b> –50%	Adjusts the vertical position of the sampling marker.
SAMPLING EXECUTE (*4)	EXEC	Executes key color sampling. The "HUE WIDTH," "HUE FINE," "SATURATION WIDTH," and "SATURATION FINE" settings are adjusted automatically.

(\*4) This can be set if "SAMPLING MARKER" is "ON."



## 8: DSK

Menu item	Value (bold text: default value)	Explanation
<b>DSK 1, 2</b>	These settings configure the DSK composite details for each DSK layer.	
DSK MODE	Sets the DSK mode.	
	<b>SELF KEY</b>	Uses the luminance key (brightness) and chroma key (color) to cut out the video image and create a composite by overlaying the video on a background video.
	ALPHA KEY	Uses alpha channels (areas which contain transparency data) to cut out still images and place them against different background video as a composite.
DSK SOURCE	EXTERNAL KEY	Sets the key signal (the shape to be cut out) and the fill video (the video to be composited) separately (external key). This uses the key signal to cut out the fill video and superimpose it on the background video to create the composite.
	<b>HDMI 1-7-8</b> , SDI 1-8, STILL 1-16 * When DSK MODE = SELF KEY <b>STILL 1-16</b> * When DSK MODE = ALPHA KEY	Specifies the source of the caption or video that is overlaid.
KEY SOURCE (*5)	<b>HDMI 1-7-8</b> , SDI 1-8, STILL 1-16	Sets the video to use as the key signal (the shape to be cut out).
FILL SOURCE (*5)	<b>HDMI 1-7-8</b> , SDI 1-8, STILL 1-16	Specifies the fill video (the video to be composited) source.
DSK TYPE (*6)	Specifies the DSK type used during DSK composition.	
	LUMINANCE-WHITE	Composite using luminance key. Makes white portions transparent according to brightness.
	<b>LUMINANCE-BLACK</b>	Composite using luminance key. Makes black portions transparent according to brightness.
	CHROMA	Composite using chroma key. Makes the specified key color transparent according to hue.
DSK LEVEL (*6)	0- <b>64</b> -255	Adjusts the degree of extraction (transparency) for the key.
DSK GAIN (*6)	<b>0</b> -255	Adjusts the degree of edge blur (semi-transmissive region) for the key.
MIX LEVEL	0- <b>255</b>	Adjusts the key's overall density (output level).
COPY SETTING FROM DSK 2 (or DSK 1)	EXEC	Copies the other DSK settings.
SWAP SETTING WITH DSK 2 (or DSK 1)	EXEC	Exchanges the settings of DSK 1 and DSK 2.
<b>CHROMA (*7)</b>	Make detailed settings for chroma key.	
COLOR	GREEN, <b>BLUE</b>	Specifies green or blue as the key color. If you want a color other than green or blue to turn transparent, use "SAMPLING MARKER" to specify the key color.
HUE WIDTH	-30- <b>0</b> -30	Adjusts the hue width for the key color.
HUE FINE	0- <b>240</b> -360	Adjusts the center position of the hue for the key color.
SATURATION WIDTH	-128- <b>0</b> -127	Adjusts the saturation width for the key color.
SATURATION FINE	<b>0</b> -255	Adjusts the center position of saturation for the key color.
SAMPLING MARKER	<b>OFF</b> , ON	When this is "ON," a sampling marker (  ) is shown for you to sample (detect) the key color. When you execute sampling, the setting automatically turns "OFF."
POSITION H (*8)	-50- <b>0</b> -50%	Adjusts the horizontal position of the sampling marker.
POSITION V (*8)	-50- <b>0</b> -50%	Adjusts the vertical position of the sampling marker.
SAMPLING EXECUTE (*8)	EXEC	Executes key color sampling. The "HUE WIDTH," "HUE FINE," "SATURATION WIDTH," and "SATURATION FINE" settings are adjusted automatically.
FILL TYPE	Sets the fill material type (the video used for key compositing).	
	<b>BUS</b>	Uses the video specified in "DSK SOURCE."
MATTE COLOR (*9)	MATTE	Uses the internal color matte (a single-color image). The superimposed caption or video is filled in with the matte color. Specify the matte color using the "MATTE COLOR" setting below.
	WHITE, YELLOW, CYAN, GREEN, MAGENTA, <b>RED</b> , BLUE, BLACK	Specifies the matte color.
EDGE TYPE	<b>OFF</b> , BORDER, DROP, SHADOW, OUTLINE	Specifies the type of edge applied to the superimposed caption or video.
EDGE COLOR	WHITE, YELLOW, CYAN, GREEN, MAGENTA, RED, BLUE, <b>BLACK</b>	Specifies the color of the edge applied to the superimposed caption or video.
EDGE WIDTH	0- <b>3</b> -14	Specifies the width of the edge applied to the superimposed caption or video.

(\*5) This can be set if "DSK MODE" is "EXTERNAL KEY."

(\*6) This can be set if "DSK MODE" is "SELF KEY."

(\*7) This can be set if "KEY TYPE" is "CHROMA."

(\*8) This can be set if "SAMPLING MARKER" is "ON."

(\*9) This can be set if "FILL TYPE" is "MATTE."

## 9: AUDIO INPUT

Menu item	Value (bold text: default value)	Explanation	
<b>AUDIO IN 1, 2</b>	Adjusts the audio that is input from the AUDIO IN 1 and 2 jacks.		
<b>AUDIO IN 1/2 (LINKED)</b>	* "AUDIO IN 1/2 (LINKED)" is shown when "STEREO LINK" is "ON."		
<b>ANALOG GAIN</b>	<b>0</b> –64dB	Adjusts the input gain (sensitivity) in the analog domain.	
<b>DIGITAL GAIN</b>	-42.0– <b>0.0</b> –42.0dB	Adjusts the input gain (sensitivity) in the digital domain (after conversion from analog to digital).	
<b>INPUT LEVEL</b>	-INF– <b>0.0</b> –10.0dB	Adjusts the input volume. This can also be adjusted by the AUDIO INPUT LEVEL [1] or [2] knob. (*10)	
<b>INPUT MUTE</b>	<b>OFF</b> , ON	Turns the mute function on/off. When this is "ON," the input audio is temporarily silenced.	
<b>PHANTOM +48V</b>	<b>OFF</b> , ON	Turns the phantom power on/off. When this is "ON," phantom power is supplied via the AUDIO IN jacks (XLR). * Changing "STEREO LINK" settings automatically turns "PHANTOM +48V" settings "OFF."	
<b>PAN (*11)</b>	LEFT– <b>CENTER</b> –RIGHT	Adjusts the stereo position (pan).	
<b>STEREO LINK</b>	<b>OFF</b> , ON	Turns the stereo link function on/off. When this is "ON," AUDIO IN 1 and 2 are linked, and operate as a stereo channel. * When stereo link is turned on, the settings of AUDIO IN 1 are applied to AUDIO IN 2.	
<b>SOLO</b>	<b>OFF</b> , ON	Turns the solo function on/off. Only the audio for which this is "ON" is heard in the headphones. * The solo function applies to the headphone output. It does not affect output other than the headphones.	
<b>EFFECT PRESET</b>	Specifies an effect preset (high-pass filter, compressor, and equalizer). When you change an effect preset, the settings of each effect are overwritten.		
	<b>DEFAULT</b>	For line input (default setting)	
	MEETING	For meetings	
	INTERVIEW	For interviews	
	WINDY FIELD	For capturing ambient sound in a windy area	
<b>DELAY</b>	<b>0.0</b> –500msec ( <b>0</b> –25.0/29.9/30.0frame)	Adjusts the delay time of the audio. <b>Effect</b> Outputs audio with a delay.	
<b>REVERB SEND</b>	<b>0</b> –127	Adjusts the amount of audio sent to reverb.	
<b>HIGH PASS FILTER 80Hz</b>	<b>OFF</b> , ON	Turns the high-pass filter on/off. <b>Effect</b> Cuts off unneeded low-band audio. The cutoff frequency is 80 Hz.	
<b>ECHO CANCELLER</b>	<b>OFF</b> , ON	Turns the echo canceller on/off. <b>Effect</b> Suppresses the voice echo that can occur when using a web conferencing system that includes a speaker and mic.	
	<b>DEPTH</b>	1– <b>5</b> –10	Adjusts the depth of the echo canceller.
<b>ANTI-FEEDBACK</b>	<b>OFF</b> , ON	Turns the anti-feedback on/off. <b>Effect</b> Suppresses audio feedback.	
<b>NOISE GATE</b>	<b>OFF</b> , ON	Turns the noise gate on/off. <b>Effect</b> Eliminates audio that is lower than the specified threshold level. This is effective when the noise that you want to remove is separate from the audio that you want to keep, and can be used to remove hiss or other noise that is heard during periods of silence.	
	<b>THRESHOLD</b>	-80– <b>-48</b> –0dB	Specifies the level used as the threshold for removing audio. Audio below the level set here is removed.
	<b>RELEASE</b>	30– <b>500</b> –5000msec	Adjusts the length of time until the audio is fully attenuated after audio falls below the threshold.
<b>DE-ESSER</b>	<b>OFF</b> , ON	Turns the de-esser on/off. <b>Effect</b> Reduces sibilant noise (the sounds you hear when pronouncing "s" words and other hissing sounds).	
	<b>SENS</b>	0– <b>80</b> –100	Adjusts the sensitivity with which sibilants are detected.
	<b>DEPTH</b>	0– <b>64</b> –100	Adjusts the intensity of the effect.
<b>COMPRESSOR</b>	<b>OFF</b> , ON	Turns the compressor on/off. <b>Effect</b> Audio that exceeds the specified threshold level is compressed. This reduces the difference between the maximum volume and minimum volume, making the audio more comfortable for listening.	
	<b>THRESHOLD</b>	-50– <b>-8</b> –0dB	Specifies the level used as the threshold at which the compressor is applied. Compression is applied to audio that exceeds the threshold.
	<b>RATIO</b>	1.00:1, 1.12:1, 1.25:1, 1.40:1, 1.60:1, 1.80:1, 2.00:1, <b>2.50:1</b> , 3.20:1, 4.00:1, 5.60:1, 8.00:1, 16.0:1, INF:1	Specifies the degree of compression applied to the audio. The state in which no compression is applied is defined as "1."
	<b>ATTACK</b>	0.0– <b>30</b> –100msec	Specifies the time until compression starts when audio exceeding the threshold is input.
	<b>RELEASE</b>	30– <b>250</b> –5000msec	Adjusts the length of time until compression ends after audio falls below the threshold.
	<b>MAKEUP GAIN</b>	-40– <b>0</b> –40dB	Adjusts the final output volume level after applying the compressor.

(\*10) The AUDIO INPUT LEVEL [2] knob is disabled when "STEREO LINK" is "ON."

(\*11) This can be set if "STEREO LINK" is "OFF."

Menu item	Value (bold text: default value)	Explanation	
EQUALIZER	<b>OFF</b> , ON	Turns the equalizer on/off. <b>Effect</b> Adjusts the volume for each frequency band.	
Hi GAIN	-15.0- <b>0.0</b> -15.0dB	Boosts or attenuates the high band.	
Hi FREQUENCY	1.00- <b>10.0</b> -20.0kHz	Adjusts the center frequency when changing the volume in the high band.	
Mid GAIN	-15.0- <b>0.0</b> -15.0dB	Boosts or attenuates the middle band.	
Mid FREQUENCY	20Hz- <b>2.00kHz</b> -20.0kHz	Adjusts the center frequency when changing the volume in the middle band.	
Mid Q	0.5- <b>1.0</b> -16.0	Adjusts the width of the frequency band when boosting or attenuating the middle band.	
Lo GAIN	-12.0- <b>0.0</b> -12.0dB	Boosts or attenuates the low band.	
Lo FREQUENCY	20Hz- <b>100Hz</b> -2.00kHz	Adjusts the center frequency when changing the volume in the low band.	
VOICE CHANGER	<b>OFF</b> , ON	Turns the voice changer on/off. <b>Effect</b> Transforms the pitch or character of the voice.	
PITCH	-12- <b>+12</b>	Adjusts the pitch of the voice in semitone steps. A setting of "0" is the original pitch.	
FORMANT	-10- <b>+4</b> - +10	Adjusts the character (formant) of the voice. Settings in the negative (-) direction produce a more masculine vocal character, and settings in the positive (+) direction produce a more feminine vocal character. A setting of "0" is the original voice.	
ROBOT	<b>OFF</b> , ON	When this is "ON," the voice is held at a fixed pitch, creating a mechanical robot-like impression.	
MIX	0- <b>100</b>	Adjusts the balance between the unprocessed voice (0) and the voice processed by the effect (100).	
<b>AUDIO IN 3/4</b>	Adjusts the audio that is input from the AUDIO IN 3/L and 4/R jacks.		
DIGITAL GAIN	-42.0- <b>0.0</b> -42.0dB	Adjusts the digital gain.	
INPUT LEVEL	- <b>INF</b> -10.0dB	Adjusts the input volume. This can also be adjusted by the AUDIO INPUT LEVEL [3/4] knob.	
INPUT MUTE	<b>OFF</b> , ON	Turns the mute function on/off. When this is "ON," the input audio is temporarily silenced.	
MONO	Converts the input audio from stereo to mono.		
	<b>OFF</b>	Sends the stereo input audio without change.	
	L ONLY	The audio of the L channel is sent to both L and R.	
	R ONLY	The audio of the R channel is sent to both L and R.	
	LR MIX	The audio of the L channel and R channel is mixed, and sent to both L and R.	
SOLO	<b>OFF</b> , ON	Turns the solo function on/off. Only the audio for which this is "ON" is heard in the headphones. * The solo function applies to the headphone output. It does not affect output other than the headphones.	
EFFECT PRESET	Specifies an effect preset (high-pass filter, compressor, and equalizer). When you change an effect preset, the settings of each effect are overwritten.		
	<b>DEFAULT</b>	For line input (default setting)	
	MEETING	For meetings	
	INTERVIEW	For interviews	
	AMBIENT MIC	For capturing ambient sound	
	WINDY FIELD	For capturing ambient sound in a windy area	
DELAY	<b>0.0</b> -500msec ( <b>0</b> -25.0/29.9/30.0frame)	Adjusts the delay time of the audio. <b>Effect</b> Outputs audio with a delay.	
REVERB SEND	<b>0</b> -127	Adjusts the amount of audio sent to reverb.	
HIGH PASS FILTER 80Hz	<b>OFF</b> , ON	Turns the high-pass filter on/off. <b>Effect</b> Cuts off unneeded low-band audio. The cutoff frequency is 80 Hz.	
NOISE GATE	<b>OFF</b> , ON	Turns the noise gate on/off. <b>Effect</b> Eliminates audio that is lower than the specified threshold level. This is effective when the noise that you want to remove is separate from the audio that you want to keep, and can be used to remove hiss or other noise that is heard during periods of silence.	
	THRESHOLD	-80- <b>-48</b> -0dB	Specifies the level used as the threshold for removing audio. Audio below the level set here is removed.
	RELEASE	30- <b>500</b> -5000msec	Adjusts the length of time until the audio is fully attenuated after audio falls below the threshold.
COMPRESSOR	<b>OFF</b> , ON	Turns the compressor on/off. <b>Effect</b> Audio that exceeds the specified threshold level is compressed. This reduces the difference between the maximum volume and minimum volume, making the audio more comfortable for listening.	
	THRESHOLD	-50- <b>-8</b> -0dB	Specifies the level used as the threshold at which the compressor is applied. Compression is applied to audio that exceeds the threshold.
	RATIO	1.00:1, 1.12:1, 1.25:1, 1.40:1, 1.60:1, 1.80:1, 2.00:1, <b>2.50:1</b> , 3.20:1, 4.00:1, 5.60:1, 8.00:1, 16.0:1, INF:1	Specifies the degree of compression applied to the audio. The state in which no compression is applied is defined as "1."
	ATTACK	0.0- <b>30</b> -100msec	Specifies the time until compression starts when audio exceeding the threshold is input.
	RELEASE	30- <b>250</b> -5000msec	Adjusts the length of time until compression ends after audio falls below the threshold.
	MAKEUP GAIN	-40- <b>0</b> -40dB	Adjusts the final output volume level after applying the compressor.

## Menu List

Menu item	Value (bold text: default value)	Explanation	
<b>EQUALIZER</b>	<b>OFF</b> , ON	Turns the equalizer on/off. <b>Effect</b> Adjusts the volume for each frequency band.	
Hi GAIN	-15.0- <b>0.0</b> -15.0dB	Boosts or attenuates the high band.	
Hi FREQUENCY	1.00- <b>10.0</b> -20.0kHz	Adjusts the center frequency when changing the volume in the high band.	
Mid GAIN	-15.0- <b>0.0</b> -15.0dB	Boosts or attenuates the middle band.	
Mid FREQUENCY	20Hz- <b>2.00kHz</b> -20.0kHz	Adjusts the center frequency when changing the volume in the middle band.	
Mid Q	0.5- <b>1.0</b> -16.0	Adjusts the width of the frequency band when boosting or attenuating the middle band.	
Lo GAIN	-12.0- <b>0.0</b> -12.0dB	Boosts or attenuates the low band.	
Lo FREQUENCY	20Hz- <b>100Hz</b> -2.00kHz	Adjusts the center frequency when changing the volume in the low band.	
<b>USB IN</b>	Adjusts the audio that is input from the USB STREAM port.		
DIGITAL GAIN	-42.0- <b>0.0</b> -42.0dB	Adjusts the digital gain.	
INPUT LEVEL	-INF- <b>0.0</b> -10.0dB	Adjusts the input volume.	
INPUT MUTE	<b>OFF</b> , ON	Turns the mute function on/off. When this is "ON," the input audio is temporarily silenced.	
<b>MONO</b>	Converts the input audio from stereo to mono.		
	<b>OFF</b>	Sends the stereo input audio without change.	
	L ONLY	The audio of the L channel is sent to both L and R.	
	R ONLY	The audio of the R channel is sent to both L and R.	
<b>SOLO</b>	<b>OFF</b> , ON	Turns the solo function on/off. Only the audio for which this is "ON" is heard in the headphones. * The solo function applies to the headphone output. It does not affect output other than the headphones.	
<b>EFFECT PRESET</b>	Specifies an effect preset (high-pass filter, compressor, and equalizer). When you change an effect preset, the settings of each effect are overwritten.		
	<b>DEFAULT</b>	For line input (default setting)	
	MEETING	For meetings	
	INTERVIEW	For interviews	
	AMBIENT MIC	For capturing ambient sound	
	WINDY FIELD	For capturing ambient sound in a windy area	
<b>DELAY</b>	<b>0.0</b> -500msec ( <b>0</b> -25.0/29.9/30.0frame)	Adjusts the delay time of the audio. <b>Effect</b> Outputs audio with a delay.	
<b>REVERB SEND</b>	<b>0</b> -127	Adjusts the amount of audio sent to reverb.	
<b>HIGH PASS FILTER 80Hz</b>	<b>OFF</b> , ON	Turns the high-pass filter on/off. <b>Effect</b> Cuts off unneeded low-band audio. The cutoff frequency is 80 Hz.	
<b>NOISE GATE</b>	<b>OFF</b> , ON	Turns the noise gate on/off. <b>Effect</b> Eliminates audio that is lower than the specified threshold level. This is effective when the noise that you want to remove is separate from the audio that you want to keep, and can be used to remove hiss or other noise that is heard during periods of silence.	
		<b>THRESHOLD</b>	-80- <b>-48</b> -0dB
		<b>RELEASE</b>	30- <b>500</b> -5000msec
<b>COMPRESSOR</b>	<b>OFF</b> , ON	Turns the compressor on/off. <b>Effect</b> Audio that exceeds the specified threshold level is compressed. This reduces the difference between the maximum volume and minimum volume, making the audio more comfortable for listening.	
		<b>THRESHOLD</b>	-50- <b>-8</b> -0dB
		<b>RATIO</b>	1.00:1, 1.12:1, 1.25:1, 1.40:1, 1.60:1, 1.80:1, 2.00:1, <b>2.50:1</b> , 3.20:1, 4.00:1, 5.60:1, 8.00:1, 16.0:1, INF:1
		<b>ATTACK</b>	0.0- <b>30</b> -100msec
		<b>RELEASE</b>	30- <b>250</b> -5000msec
		<b>MAKEUP GAIN</b>	-40- <b>0</b> -40dB
<b>EQUALIZER</b>	<b>OFF</b> , ON	Turns the equalizer on/off. <b>Effect</b> Adjusts the volume for each frequency band.	
Hi GAIN	-15.0- <b>0.0</b> -15.0dB	Boosts or attenuates the high band.	
Hi FREQUENCY	1.00- <b>10.0</b> -20.0kHz	Adjusts the center frequency when changing the volume in the high band.	
Mid GAIN	-15.0- <b>0.0</b> -15.0dB	Boosts or attenuates the middle band.	
Mid FREQUENCY	20Hz- <b>2.00kHz</b> -20.0kHz	Adjusts the center frequency when changing the volume in the middle band.	
Mid Q	0.5- <b>1.0</b> -16.0	Adjusts the width of the frequency band when boosting or attenuating the middle band.	
Lo GAIN	-12.0- <b>0.0</b> -12.0dB	Boosts or attenuates the low band.	
Lo FREQUENCY	20Hz- <b>100Hz</b> -2.00kHz	Adjusts the center frequency when changing the volume in the low band.	

Menu item	Value (bold text: default value)	Explanation	
<b>Bluetooth IN</b>	These parameters adjust the audio input via Bluetooth connection.		
DIGITAL GAIN	-42.0- <b>0.0</b> -42.0dB	Adjusts the digital gain.	
INPUT LEVEL	-INF- <b>0.0</b> -10.0dB	Adjusts the input volume.	
INPUT MUTE	<b>OFF</b> , ON	Turns the mute function on/off. When this is "ON," the input audio is temporarily silenced.	
MONO	Converts the input audio from stereo to mono.		
	<b>OFF</b>	Sends the stereo input audio without change.	
	L ONLY	The audio of the L channel is sent to both L and R.	
	R ONLY	The audio of the R channel is sent to both L and R.	
LR MIX	The audio of the L channel and R channel is mixed, and sent to both L and R.		
	<b>OFF</b> , ON	Turns the solo function on/off. Only the audio for which this is "ON" is heard in the headphones. * The solo function applies to the headphone output. It does not affect output other than the headphones.	
EFFECT PRESET	Specifies an effect preset (high-pass filter, compressor, and equalizer). When you change an effect preset, the settings of each effect are overwritten.		
	<b>DEFAULT</b>	For line input (default setting)	
	MEETING	For meetings	
	INTERVIEW	For interviews	
	AMBIENT MIC	For capturing ambient sound	
WINDY FIELD	For capturing ambient sound in a windy area		
DELAY	<b>0.0</b> -500msec (0-25.0/29.9/30.0frame)	Adjusts the delay time of the audio. <b>Effect</b> Outputs audio with a delay.	
REVERB SEND	<b>0</b> -127	Adjusts the amount of audio sent to reverb.	
HIGH PASS FILTER 80Hz	<b>OFF</b> , ON	Turns the high-pass filter on/off. <b>Effect</b> Cuts off unneeded low-band audio. The cutoff frequency is 80 Hz.	
NOISE GATE	<b>OFF</b> , ON	Turns the noise gate on/off. <b>Effect</b> Eliminates audio that is lower than the specified threshold level. This is effective when the noise that you want to remove is separate from the audio that you want to keep, and can be used to remove hiss or other noise that is heard during periods of silence.	
	<b>THRESHOLD</b>	-80- <b>-48</b> -0dB	Specifies the level used as the threshold for removing audio. Audio below the level set here is removed.
RELEASE	30- <b>500</b> -5000msec	Adjusts the length of time until the audio is fully attenuated after audio falls below the threshold.	
COMPRESSOR	<b>OFF</b> , ON	Turns the compressor on/off. <b>Effect</b> Audio that exceeds the specified threshold level is compressed. This reduces the difference between the maximum volume and minimum volume, making the audio more comfortable for listening.	
	<b>THRESHOLD</b>	-50- <b>-8</b> -0dB	Specifies the level used as the threshold at which the compressor is applied. Compression is applied to audio that exceeds the threshold.
	<b>RATIO</b>	1.00:1, 1.12:1, 1.25:1, 1.40:1, 1.60:1, 1.80:1, 2.00:1, <b>2.50:1</b> , 3.20:1, 4.00:1, 5.60:1, 8.00:1, 16.0:1, INF:1	Specifies the degree of compression applied to the audio. The state in which no compression is applied is defined as "1."
	<b>ATTACK</b>	0.0- <b>30</b> -100msec	Specifies the time until compression starts when audio exceeding the threshold is input.
	<b>RELEASE</b>	30- <b>250</b> -5000msec	Adjusts the length of time until compression ends after audio falls below the threshold.
	<b>MAKEUP GAIN</b>	-40- <b>0</b> -40dB	Adjusts the final output volume level after applying the compressor.
EQUALIZER	<b>OFF</b> , ON	Turns the equalizer on/off. <b>Effect</b> Adjusts the volume for each frequency band.	
	<b>Hi GAIN</b>	-15.0- <b>0.0</b> -15.0dB	Boosts or attenuates the high band.
	<b>Hi FREQUENCY</b>	1.00- <b>10.0</b> -20.0kHz	Adjusts the center frequency when changing the volume in the high band.
	<b>Mid GAIN</b>	-15.0- <b>0.0</b> -15.0dB	Boosts or attenuates the middle band.
	<b>Mid FREQUENCY</b>	20Hz- <b>2.00kHz</b> -20.0kHz	Adjusts the center frequency when changing the volume in the middle band.
	<b>Mid Q</b>	0.5- <b>1.0</b> -16.0	Adjusts the width of the frequency band when boosting or attenuating the middle band.
	<b>Lo GAIN</b>	-12.0- <b>0.0</b> -12.0dB	Boosts or attenuates the low band.
	<b>Lo FREQUENCY</b>	20Hz- <b>100Hz</b> -2.00kHz	Adjusts the center frequency when changing the volume in the low band.

## Menu List

Menu item	Value (bold text: default value)	Explanation		
<b>HDMI IN 1–8</b> Adjusts the audio that is input from the HDMI IN 1–8 connectors.				
DIGITAL GAIN	-42.0– <b>0.0</b> –42.0dB	Adjusts the digital gain.		
INPUT LEVEL	-INF– <b>0.0</b> –10.0dB	Adjusts the input volume.		
INPUT MUTE	<b>OFF</b> , ON	Turns the mute function on/off. When this is “ON,” the input audio is temporarily silenced.		
MONO	Converts the input audio from stereo to mono.			
	<b>OFF</b>	Sends the stereo input audio without change.		
	L ONLY	The audio of the L channel is sent to both L and R.		
	R ONLY	The audio of the R channel is sent to both L and R.		
	LR MIX	The audio of the L channel and R channel is mixed, and sent to both L and R.		
SOLO	<b>OFF</b> , ON	Turns the solo function on/off. Only the audio for which this is “ON” is heard in the headphones. * The solo function applies to the headphone output. It does not affect output other than the headphones.		
EFFECT PRESET	Specifies an effect preset (high-pass filter, compressor, and equalizer). When you change an effect preset, the settings of each effect are overwritten.			
	<b>DEFAULT</b>	For line input (default setting)		
	MEETING	For meetings		
	INTERVIEW	For interviews		
	AMBIENT MIC	For capturing ambient sound		
	WINDY FIELD	For capturing ambient sound in a windy area		
DELAY	<b>0.0</b> –500msec ( <b>0</b> –25.0/29.9/30.0frame)	Adjusts the delay time of the audio. <b>Effect</b> Outputs audio with a delay.		
REVERB SEND	<b>0</b> –127	Adjusts the amount of audio sent to reverb.		
HIGH PASS FILTER 80Hz	<b>OFF</b> , ON	Turns the high-pass filter on/off. <b>Effect</b> Cuts off unneeded low-band audio. The cutoff frequency is 80 Hz.		
NOISE GATE	<b>OFF</b> , ON	Turns the noise gate on/off.		
		<b>Effect</b> Eliminates audio that is lower than the specified threshold level. This is effective when the noise that you want to remove is separate from the audio that you want to keep, and can be used to remove hiss or other noise that is heard during periods of silence.		
		Specifies the level used as the threshold for removing audio. Audio below the level set here is removed.		
THRESHOLD	-80– <b>-48</b> –0dB			
RELEASE	30– <b>500</b> –5000msec	Adjusts the length of time until the audio is fully attenuated after audio falls below the threshold.		
COMPRESSOR	<b>OFF</b> , ON	Turns the compressor on/off.		
		<b>Effect</b> Audio that exceeds the specified threshold level is compressed. This reduces the difference between the maximum volume and minimum volume, making the audio more comfortable for listening.		
	THRESHOLD	-50– <b>-8</b> –0dB	Specifies the level used as the threshold at which the compressor is applied. Compression is applied to audio that exceeds the threshold.	
	RATIO	1.00:1, 1.12:1, 1.25:1, 1.40:1, 1.60:1, 1.80:1, 2.00:1, <b>2.50:1</b> , 3.20:1, 4.00:1, 5.60:1, 8.00:1, 16.0:1, INF:1	Specifies the degree of compression applied to the audio. The state in which no compression is applied is defined as “1.”	
	ATTACK	0.0– <b>30</b> –100msec	Specifies the time until compression starts when audio exceeding the threshold is input.	
	RELEASE	30– <b>250</b> –5000msec	Adjusts the length of time until compression ends after audio falls below the threshold.	
	MAKEUP GAIN	-40– <b>0</b> –40dB	Adjusts the final output volume level after applying the compressor.	
EQUALIZER	<b>OFF</b> , ON	Turns the equalizer on/off.		
		<b>Effect</b> Adjusts the volume for each frequency band.		
		Hi GAIN	-15.0– <b>0.0</b> –15.0dB	Boosts or attenuates the high band.
		Hi FREQUENCY	1.00– <b>10.0</b> –20.0kHz	Adjusts the center frequency when changing the volume in the high band.
		Mid GAIN	-15.0– <b>0.0</b> –15.0dB	Boosts or attenuates the middle band.
		Mid FREQUENCY	20Hz– <b>2.00kHz</b> –20.0kHz	Adjusts the center frequency when changing the volume in the middle band.
		Mid Q	0.5– <b>1.0</b> –16.0	Adjusts the width of the frequency band when boosting or attenuating the middle band.
		Lo GAIN	-12.0– <b>0.0</b> –12.0dB	Boosts or attenuates the low band.
		Lo FREQUENCY	20Hz– <b>100Hz</b> –2.00kHz	Adjusts the center frequency when changing the volume in the low band.

Menu item	Value (bold text: default value)	Explanation	
<b>SDI IN 1–8</b>	Adjusts the audio that is input from the SDI IN 1–8 connectors.		
DIGITAL GAIN	-42.0– <b>0.0</b> –42.0dB	Adjusts the digital gain.	
INPUT LEVEL	-INF– <b>0.0</b> –10.0dB	Adjusts the input volume.	
INPUT MUTE	<b>OFF</b> , ON	Turns the mute function on/off. When this is “ON,” the input audio is temporarily silenced.	
MONO	Converts the input audio from stereo to mono.		
	<b>OFF</b>	Sends the stereo input audio without change.	
	L ONLY	The audio of the L channel is sent to both L and R.	
	R ONLY	The audio of the R channel is sent to both L and R.	
LR MIX	The audio of the L channel and R channel is mixed, and sent to both L and R.		
	<b>OFF</b> , ON	Turns the solo function on/off. Only the audio for which this is “ON” is heard in the headphones. * The solo function applies to the headphone output. It does not affect output other than the headphones.	
EFFECT PRESET	Specifies an effect preset (high-pass filter, compressor, and equalizer). When you change an effect preset, the settings of each effect are overwritten.		
	<b>DEFAULT</b>	For line input (default setting)	
	MEETING	For meetings	
	INTERVIEW	For interviews	
	AMBIENT MIC	For capturing ambient sound	
WINDY FIELD	For capturing ambient sound in a windy area		
DELAY	<b>0.0</b> –500msec ( <b>0</b> –25.0/29.9/30.0frame)	Adjusts the delay time of the audio. <b>Effect</b> Outputs audio with a delay.	
REVERB SEND	<b>0</b> –127	Adjusts the amount of audio sent to reverb.	
HIGH PASS FILTER 80Hz	<b>OFF</b> , ON	Turns the high-pass filter on/off. <b>Effect</b> Cuts off unneeded low-band audio. The cutoff frequency is 80 Hz.	
NOISE GATE	<b>OFF</b> , ON	Turns the noise gate on/off. <b>Effect</b> Eliminates audio that is lower than the specified threshold level. This is effective when the noise that you want to remove is separate from the audio that you want to keep, and can be used to remove hiss or other noise that is heard during periods of silence.	
	<b>THRESHOLD</b>	-80– <b>-48</b> –0dB	Specifies the level used as the threshold for removing audio. Audio below the level set here is removed.
<b>RELEASE</b>	30– <b>500</b> –5000msec	Adjusts the length of time until the audio is fully attenuated after audio falls below the threshold.	
COMPRESSOR	<b>OFF</b> , ON	Turns the compressor on/off. <b>Effect</b> Audio that exceeds the specified threshold level is compressed. This reduces the difference between the maximum volume and minimum volume, making the audio more comfortable for listening.	
	<b>THRESHOLD</b>	-50– <b>-8</b> –0dB	Specifies the level used as the threshold at which the compressor is applied. Compression is applied to audio that exceeds the threshold.
<b>RATIO</b>	1.00:1, 1.12:1, 1.25:1, 1.40:1, 1.60:1, 1.80:1, 2.00:1, <b>2.50:1</b> , 3.20:1, 4.00:1, 5.60:1, 8.00:1, 16.0:1, INF:1	Specifies the degree of compression applied to the audio. The state in which no compression is applied is defined as “1.”	
<b>ATTACK</b>	0.0– <b>30</b> –100msec	Specifies the time until compression starts when audio exceeding the threshold is input.	
<b>RELEASE</b>	30– <b>250</b> –5000msec	Adjusts the length of time until compression ends after audio falls below the threshold.	
<b>MAKEUP GAIN</b>	-40– <b>0</b> –40dB	Adjusts the final output volume level after applying the compressor.	
EQUALIZER	<b>OFF</b> , ON	Turns the equalizer on/off. <b>Effect</b> Adjusts the volume for each frequency band.	
	<b>Hi GAIN</b>	-15.0– <b>0.0</b> –15.0dB	Boosts or attenuates the high band.
	<b>Hi FREQUENCY</b>	1.00– <b>10.0</b> –20.0kHz	Adjusts the center frequency when changing the volume in the high band.
	<b>Mid GAIN</b>	-15.0– <b>0.0</b> –15.0dB	Boosts or attenuates the middle band.
	<b>Mid FREQUENCY</b>	20Hz– <b>2.00kHz</b> –20.0kHz	Adjusts the center frequency when changing the volume in the middle band.
	<b>Mid Q</b>	0.5– <b>1.0</b> –16.0	Adjusts the width of the frequency band when boosting or attenuating the middle band.
	<b>Lo GAIN</b>	-12.0– <b>0.0</b> –12.0dB	Boosts or attenuates the low band.
	<b>Lo FREQUENCY</b>	20Hz– <b>100Hz</b> –2.00kHz	Adjusts the center frequency when changing the volume in the low band.

## 10: AUDIO OUTPUT

Menu item	Value (bold text: default value)	Explanation						
<b>OUTPUT ASSIGN</b>	Specifies the audio bus that is assigned to each connector.							
AUDIO OUT (XLR)	<b>MASTER OUTPUT</b> , AUX	<b>MASTER OUTPUT:</b> All input audio is mixed and output (master output).  <b>AUX:</b> Only the input audio sent to the AUX bus is mixed and output. This allows you to output audio that is different than the master output.  <b>AUTO:</b> The audio bus automatically switches according to the video bus assignment.						
AUDIO OUT (RCA)	<b>MASTER OUTPUT</b> , AUX							
PHONES OUT	<b>MASTER OUTPUT</b> , AUX							
USB OUT	<b>MASTER OUTPUT</b> , AUX							
HDMI OUT 1-3	<b>AUTO</b> , MASTER OUTPUT, AUX	<table border="1"> <thead> <tr> <th>Video bus</th> <th>Audio bus</th> </tr> </thead> <tbody> <tr> <td>Others besides AUX</td> <td>MASTER OUTPUT</td> </tr> <tr> <td>AUX</td> <td>AUX</td> </tr> </tbody> </table>	Video bus	Audio bus	Others besides AUX	MASTER OUTPUT	AUX	AUX
Video bus	Audio bus							
Others besides AUX	MASTER OUTPUT							
AUX	AUX							
SDI OUT 1-3	<b>AUTO</b> , MASTER OUTPUT, AUX							
<b>MASTER OUTPUT</b>	Adjusts the audio of the MASTER OUTPUT bus.							
OUTPUT LEVEL	-INF- <b>0.0</b> -10.0dB	Adjusts the output volume. This can also be adjusted by the [MASTER OUTPUT] knob.						
OUTPUT MUTE	<b>OFF</b> , ON	Turns the mute function on/off. When this is "ON," the output audio is temporarily silenced.						
OUTPUT DELAY	<b>0.0</b> -500msec ( <b>0</b> -25.0/29.9/30.0frame)	Adjusts the delay time of the audio. <b>Effect</b> Outputs audio with a delay.						
LIMITER	<b>OFF</b> , ON	Turns the limiter on/off. <b>Effect</b> Limits the output volume so that it does not exceed the specified threshold level. * Distortion will occur if audio that exceeds the allowable range of the limiter is input.						
THRESHOLD	-40- <b>-6</b> -0dB	Adjusts the level that becomes the threshold at which the limiter is applied. Compression is applied to audio that exceeds the threshold. The volume level of audio that is output is limited so as to stay below the threshold.						
REVERB	<b>OFF</b> , ON	Turns reverb on/off. <b>Effect</b> Adds reverberation to the sound.						
LEVEL	<b>0</b> -127	Specifies the amount of sound that is returned from the reverb (return level). This adjusts the depth of the overall reverb.						
TYPE	Specifies the reverb type.							
	<b>ROOM</b>	Produces the natural-sounding reverberation of a room.						
	HALL	Produces the reverberation that is typical of a performance in a concert hall.						
SIZE	1- <b>10</b> -20	Specifies the size of the room. The larger the value, the longer the reverb time.						
EQUALIZER	<b>OFF</b> , ON	Turns the equalizer on/off. <b>Effect</b> Adjusts the volume for each frequency band.						
Hi GAIN	-15.0- <b>0.0</b> -15.0dB	Boosts or attenuates the high band.						
Hi FREQUENCY	1.00- <b>10.0</b> -20.0kHz	Adjusts the center frequency when changing the volume in the high band.						
Mid GAIN	-15.0- <b>0.0</b> -15.0dB	Boosts or attenuates the middle band.						
Mid FREQUENCY	20Hz- <b>2.00kHz</b> -20.0kHz	Adjusts the center frequency when changing the volume in the middle band.						
Mid Q	0.5- <b>1.0</b> -16.0	Adjusts the width of the frequency band when boosting or attenuating the middle band.						
Lo GAIN	-12.0- <b>0.0</b> -12.0dB	Boosts or attenuates the low band.						
Lo FREQUENCY	20Hz- <b>100Hz</b> -2.00kHz	Adjusts the center frequency when changing the volume in the low band.						
MULTI BAND COMPRESSOR	<b>OFF</b> , ON	Turns the multi-band compressor on/off. <b>Effect</b> Applies separate compressors in individual frequency band.						
Hi THRESHOLD	-40- <b>-20</b> -0dB	Specifies the threshold level at which the compressor is applied to the high band. Compression is applied to audio that exceeds the threshold.						
Hi RATIO	1.00 : 1, 1.12 : 1, 1.25 : 1, 1.40 : 1, 1.60 : 1, 1.80 : 1, 2.00 : 1, 2.50 : 1, <b>3.20 : 1</b> , 4.00 : 1, 5.60 : 1, 8.00 : 1, 16.0 : 1, INF : 1	Specifies the amount of compression applied in the high band. The state in which no compression is applied is defined as "1."						
Mid THRESHOLD	-40- <b>-16</b> -0dB	Specifies the threshold level at which the compressor is applied to the middle band. Compression is applied to audio that exceeds the threshold.						
Mid RATIO	1.00 : 1, 1.12 : 1, 1.25 : 1, 1.40 : 1, 1.60 : 1, 1.80 : 1, 2.00 : 1, <b>2.50</b> : 1, 3.20 : 1, 4.00 : 1, 5.60 : 1, 8.00 : 1, 16.0 : 1, INF : 1	Specifies the amount of compression applied in the middle band. The state in which no compression is applied is defined as "1."						
Lo THRESHOLD	-50- <b>-20</b> -0dB	Specifies the threshold level at which the compressor is applied to the low band. Compression is applied to audio that exceeds the threshold.						
Lo RATIO	1.00 : 1, 1.12 : 1, 1.25 : 1, 1.40 : 1, 1.60 : 1, 1.80 : 1, 2.00 : 1, 2.50 : 1, <b>3.20</b> : 1, 4.00 : 1, 5.60 : 1, 8.00 : 1, 16.0 : 1, INF : 1	Specifies the amount of compression applied in the low band. The state in which no compression is applied is defined as "1."						



Menu item	Value (bold text: default value)	Explanation
<b>AUX</b> Adjusts the audio of the AUX bus.		
AUX LEVEL	-INF- <b>0.0</b> -10.0dB	Adjusts the output volume. This can also be adjusted by the [AUX] knob.
AUX MUTE	<b>OFF</b> , ON	Turns the mute function on/off. When this is "ON," the output audio is temporarily silenced.
AUX DELAY	<b>0.0</b> -500msec ( <b>0</b> -25.0/29.9/30.0frame)	Adjusts the delay time of the audio. <b>Effect</b> Outputs audio with a delay.
LIMITER	<b>OFF</b> , ON	Turns the limiter on/off. <b>Effect</b> Limits the output volume so that it does not exceed the specified threshold level. * Distortion will occur if audio that exceeds the allowable range of the limiter is input.
THRESHOLD	-40-- <b>6</b> -0dB	Adjusts the level that becomes the threshold at which the limiter is applied. Compression is applied to audio that exceeds the threshold. The volume level of audio that is output is limited so as to stay below the threshold.
ENTER Displays the AUX SEND menu.		
AUX SEND	<b>Menu item</b>	<b>Value</b>
	AUDIO IN 1-3/4	-INF, 0dB
	USB IN	-INF, 0dB
	Bluetooth IN	-INF, 0dB
	AUX SEND VIDEO	Selects how to configure the amount of signal sent to the AUX bus for HDMI/SDI IN 1-8.
		<b>AUTO</b> Audio is automatically sent to the AUX bus in tandem with the AUX bus video selection.
		MANUAL The amount of audio to send is adjusted manually.
HDMI IN 1-8	-INF, 0dB	Adjusts the amount of audio sent to the AUX bus for each input.
SDI IN 1-8	-INF, 0dB	* This can be set if "AUX SEND VIDEO" is "MANUAL."
ENTER Displays the AUX EFFECT menu.		
AUX EFFECT	<b>Menu item</b>	<b>Value</b>
	AUDIO IN 1-3/4	Sets whether to send audio from each input to the AUX bus with effects applied or not.
	USB IN	DRY Sends the source audio with no effects applied.
	Bluetooth IN	<b>PRE FADER</b> Sends the effect-applied audio.
	HDMI IN 1-8	The send volume is constant, regardless of the volume (INPUT LEVEL).
SDI IN 1-8	<b>POST FADER</b> Sends the effect-applied audio.	
	The send volume can be changed by adjusting the volume (INPUT LEVEL).	
<b>USB OUT</b> Adjusts the audio that is output from the USB STREAM port.		
USB OUTPUT LEVEL	-INF- <b>0.0</b> -10.0dB	Adjusts the output volume. This can also be adjusted by the [USB STREAM] knob.
USB OUTPUT MUTE	<b>OFF</b> , ON	Turns the mute function on/off. When this is "ON," the output audio is temporarily silenced.
USB OUTPUT DELAY	<b>0.0</b> -500msec ( <b>0</b> -25.0/29.9/30.0frame)	Adjusts the delay time of the audio. <b>Effect</b> Outputs audio with a delay.
EQUALIZER	<b>OFF</b> , ON	Turns the equalizer on/off. <b>Effect</b> Adjusts the volume for each frequency band.
Hi GAIN	-15.0- <b>0.0</b> -15.0dB	Boosts or attenuates the high band.
Hi FREQUENCY	1.00- <b>10.0</b> -20.0kHz	Adjusts the center frequency when changing the volume in the high band.
Mid GAIN	-15.0- <b>0.0</b> -15.0dB	Boosts or attenuates the middle band.
Mid FREQUENCY	20Hz- <b>2.00kHz</b> -20.0kHz	Adjusts the center frequency when changing the volume in the middle band.
Mid Q	0.5- <b>1.0</b> -16.0	Adjusts the width of the frequency band when boosting or attenuating the middle band.
Lo GAIN	-12.0- <b>0.0</b> -12.0dB	Boosts or attenuates the low band.
Lo FREQUENCY	20Hz- <b>100Hz</b> -2.00kHz	Adjusts the center frequency when changing the volume in the low band.

Menu item	Value (bold text: default value)	Explanation
<b>HDMI/SDI AUDIO EMBEDDED</b> Settings related to embedded audio for the HDMI/SDI output.		
<b>HDMI OUT 1-3 SEND</b>	These parameters set the input audio to send to HDMI embedded audio channels 3–8.	
CH 3-4	<b>N/A</b> , AUDIO IN 1/2,	When this is set to "N/A," no audio is sent.
CH 5-6	AUDIO IN 3/4, USB IN,	* The following audio buses are assigned for channels 1 and 2.
CH 7-8	Bluetooth IN, HDMI 1–8, SDI 1–8	Channel 1: MASTER OUTPUT (L) or AUX (L) Channel 2: MASTER OUTPUT (R) or AUX (R)
<b>SDI OUT 1-3 SEND</b>	These parameters set the input audio to send to SDI embedded audio channels 3–8.	
CH 3-4	<b>N/A</b> , AUDIO IN 1/2,	When this is set to "N/A," no audio is sent.
CH 5-6	AUDIO IN 3/4, USB IN,	* The following audio buses are assigned for channels 1 and 2.
CH 7-8	Bluetooth IN, HDMI 1–8, SDI 1–8	Channel 1: MASTER OUTPUT (L) or AUX (L) Channel 2: MASTER OUTPUT (R) or AUX (R)
<b>AUDIO IN 1–3/4 USB IN Bluetooth IN HDMI IN 1–8 SDI IN 1–8</b>	Sets whether to send audio with effects applied from each input to the HDMI/SDI embedded audio channels (3–8).	
	OFF	Audio is not sent.
	DRY	Sends the source audio with no effects applied.
	<b>PRE FADER</b>	Sends the effect-applied audio. The send volume is constant, regardless of the volume (INPUT LEVEL).
	POST FADER	Sends the effect-applied audio. The send volume can be changed by adjusting the volume (INPUT LEVEL).

## 11: AUDIO FOLLOW

Menu item	Value (bold text: default value)	Explanation
<b>ALL AUDIO FOLLOW</b>	<b>OFF</b> , ON	Turns on/off the audio follow function for HDMI 1–8 and SDI 1–8 in a single action.
<b>HDMI 1–8 SDI 1–8</b>	Turns the audio follow function on/off. Audio follow is a function that automatically switches the audio output in tandem with video switching.	
	<b>OFF</b>	The audio is always output regardless of the video selection.
	ON	The audio is output only when the video is selected. The audio is automatically muted if another video is selected.
<b>AUDIO IN 1–3/4 USB IN Bluetooth IN</b>	<b>OFF</b> , INPUT 1–10	For each audio source, these settings specify the input video (INPUT 1–10) that will use the audio follow function. Audio is output only when the specified input video is selected. When this is "OFF," the audio is always output regardless of the video selection.

## 12: AUDIO AUTO MIXING

Menu item	Value (bold text: default value)	Explanation
<b>AUDIO AUTO MIXING</b>	<b>OFF</b> , ON	Turns the auto mixing function on/off. Auto mixing is a function that automatically controls the volume adjustments.
<b>AUDIO IN 1, 2 AUDIO IN 3/4 USB IN Bluetooth IN HDMI 1–8 SDI 1–8</b>	DISABLE, <b>ENABLE</b>	Specifies whether Auto Mixing is applied (ENABLE) or not applied (DISABLE).
<b>WEIGHT</b>	0– <b>100%</b>	
Specifies the weight level (the priority of volume distribution). * Setting the weight level to "0" results in no audio output.		

## 13: PRESET MEMORY

Menu item	Value (bold text: default value)	Explanation
LOAD	<b>1: MEMORY 1</b> – 30: MEMORY 30 (*12)	Selects the preset memory to load. Pressing the [VALUE] knob lets you load the preset memory. When “MEMORY” is selected on the [MODE] button, you can use the MEMORY [1]–[10] buttons to recall preset memories 1–10.
SAVE	<b>1: MEMORY 1</b> – 30: MEMORY 30 (*12)	Selects a preset memory for saving settings. Pressing the [VALUE] knob lets you save the settings to the preset memory. When “MEMORY” is selected on the [MODE] button, you can long-press the MEMORY [1]–[10] buttons to save the settings to preset memories 1–10. * The following settings are not saved in preset memory. <ul style="list-style-type: none"> <li>• PRESET MEMORY menu</li> <li>• MACRO menu</li> <li>• SEQUENCER menu</li> <li>• STILL IMAGE menu</li> <li>• FREEZE menu</li> <li>• AUTO SWITCHING menu</li> <li>• CTL/EXP menu</li> <li>• RS-232/TALLY/GPO/GPI menu</li> <li>• LAN CONTROL menu</li> <li>• CAMERA CONTROL menu</li> <li>• USB MEMORY menu</li> <li>• SYSTEM menu</li> </ul>
INITIALIZE	ALL, <b>1: MEMORY 1</b> – 30: MEMORY 30 (*12)	Selects the preset memory to be initialized. Press the [VALUE] knob to initialize the preset memory.
NAME EDIT	<b>1: MEMORY 1</b> – 30: MEMORY 30 (*12)	Selects the preset memory to be renamed. Press the [VALUE] knob to access the screen for editing the name.
START UP	Specifies the settings loaded at startup.	
	<b>LAST MEMORY</b>	Restores the state that was in effect immediately before the power was turned off (Last Memory feature). The current settings (Last Memory values) are saved every 4 seconds, and when you exit a menu.
	1: MEMORY 1– 30: MEMORY 30 (*12)	Recall the settings at the selected preset memory.
MEMORY PROTECT	<b>OFF</b> , ON	When this is “ON,” prohibits settings from being saved or initialized. This protects the preset memories. * Protected preset memories are erased if you perform a factory reset.
NUMBER OF MEMORY SW	When “MEMORY” is selected on the [MODE] button, this sets how many buttons function as memory selection buttons.	
	<b>10</b>	Preset memory 1–10: MEMORY [1]–[10] buttons
	30	Preset memory 1–10: MEMORY [1]–[10] buttons Preset memory 11–20: PGM/A [1]–[10] buttons Preset memory 21–30: PST/B [1]–[10] buttons
FADE TIME	<b>0.0</b> –4.0sec	Sets how long the transition to the next video takes when recalling a preset memory. * The time you set is used for the parameters below.
MIX/WIPE	OFF, <b>ON</b>	When this is “ON,” the transition effect is applied when the preset memory is recalled.
PinP & KEY 1–4	OFF, <b>ON</b>	When this is “ON,” the inset screen fades in when you recall a preset memory that includes a PinP composite.
DSK 1, 2	OFF, <b>ON</b>	When this is “ON,” the superimposed caption and video fades in when you recall a preset memory that includes a DSK composite.
LOAD PARAMETER	Specifies whether to recall the following items when recalling a preset memory. Items that are turned off are excluded from the preset memories that are recalled.	
VIDEO ASSIGN	OFF, <b>ON</b>	VIDEO ASSIGN menu
VIDEO INPUT	OFF, <b>ON</b>	VIDEO INPUT menu
VIDEO OUTPUT	OFF, <b>ON</b>	VIDEO OUTPUT menu
TRANSITION TIME	OFF, <b>ON</b>	TRANSITION TIME menu
MIX/WIPE	OFF, <b>ON</b>	MIX/WIPE menu
SPLIT	OFF, <b>ON</b>	SPLIT menu
PinP & KEY	OFF, <b>ON</b>	PinP menu
DSK	OFF, <b>ON</b>	DSK menu
VIDEO CROSSPOINT	OFF, <b>ON</b>	Cross-point button state
VIDEO FADER	<b>INITIALIZE</b> , ON	Video fader position When set to “INITIALIZE,” the video fader position is recalled when the video fader is pushed all the way up or pulled all the way down.
AUDIO INPUT	OFF, <b>ON</b>	AUDIO INPUT menu
AUDIO OUTPUT	OFF, <b>ON</b>	AUDIO OUTPUT menu
AUDIO FOLLOW	OFF, <b>ON</b>	AUDIO FOLLOW menu
AUDIO AUTO MIXING	OFF, <b>ON</b>	AUDIO AUTO MIXING menu

(\*12) If you edited a preset memory’s name using “NAME EDIT,” the edited name is shown.

## 14: MACRO

Menu item	Value (bold text: default value)	Explanation	
EXECUTE	<b>1: DEMO 1</b> – 100: MACRO100 (*13)	Select a macro (a series of recorded operations) to execute. Press the [VALUE] knob to execute the macro. When “MACRO” is selected on the [MODE] button, you can use the MACRO [1]–[10] buttons to execute macros 1–10.	
INITIALIZE	ALL, <b>1: DEMO 1</b> – 100: MACRO100 (*13)	Selects the macro to be initialized. Press the [VALUE] knob to initialize the macro.	
LIST EDIT	<b>1: DEMO 1</b> – 100: MACRO100 (*13)	Selects the macro to edit. Press the [VALUE] knob to show the operations recorded in the macro.	
	<b>Menu item</b>	<b>Value</b>	<b>Explanation</b>
	<b>1: (operation name)– 10: (operation name)</b>	—	Shows the list of operations recorded in the macro. “-----” is shown if no operations are recorded. Select an operation or “ADD NEW FUNCTION” and press the [VALUE] knob to display the FUNCTION EDIT menu (shown below) for editing the operation.
	PREVIEW	EXEC	Previews the macro.
	COPY MACRO TO	<b>1: DEMO 1</b> – 100: MACRO100 (*13)	Specifies the macro copy source. Press the [VALUE] knob to copy the macro.
SWAP MACRO WITH	<b>1: DEMO 1</b> – 100: MACRO100 (*13)	Specifies the macro swap destination. Press the [VALUE] knob to swap the macro.	
NAME EDIT	<b>1: DEMO 1</b> – 100: MACRO100 (*13)	Selects the macro to be renamed. Press the [VALUE] knob to access the screen for editing the name.	
LOAD FROM USB MEMORY	ENTER	Shows a list of the macro setting files (.RMF) that are on the USB flash drive. You can select a macro setting file and load the macro (1–100) into the unit.	
SAVE TO USB MEMORY	ENTER	Shows a list of the macro setting files (.RMF) that are on the USB flash drive. You can select the macro settings file used to save the macro (1–100) to the USB flash drive. If you selected “NEW FILE...,” a new macro settings file is saved.	
NUMBER OF MACRO SW	When “MACRO” is selected on the [MODE] button, this sets how many buttons function as macro selection buttons.		
	<b>10</b>	MACRO [1]–[10] buttons	
	30	MACRO [1]–[10] buttons, PGM/A [1]–[10] buttons, PST/B [1]–[10] buttons	
SW ASSIGN	ENTER	Displays the SW ASSIGN menu.	
	Specifies the macro assigned to each button.		
	<b>Menu item</b>	<b>Value</b>	<b>Explanation</b>
	MACRO 1–10	<b>1: DEMO 1</b> – 100: MACRO100 (*13)	MACRO [1]–[10] buttons
PGM/A 1–10 (*14)		PGM/A [1]–[10] buttons	
PST/B 1–10 (*14)		PST/B [1]–[10] buttons	

(\*13) If you edited a macro’s name using “NAME EDIT,” the edited name is shown.

(\*14) This can be set if “NUMBER OF MACRO SW” is “30.”

## FUNCTION EDIT

Menu item	Value (bold text: default value)	Explanation
FUNCTION	PGM TAKE PGM/PST SELECT AUX SELECT INPUT ASSIGN TRANSITION TIME TRANSITION TYPE PinP & KEY ON/OFF PinP & KEY SOURCE PinP & KEY WINDOW DSK ON/OFF DSK SOURCE SPLIT ON/OFF SPLIT TYPE	SPLIT POSITION AUDIO INPUT LEVEL AUDIO INPUT MUTE AUDIO OUTPUT LEVEL AUDIO OUTPUT MUTE PRESET MEMORY MACRO OUTPUT FADE REC CONTROL GPO ONE SHOT GPO ALTERNATE CAMERA PRESET RECALL WAIT
		Sets the operation to record to the macro. * The related menu is shown according to the operation you set.
		<b>WAIT:</b> Sets the waiting time before the next operation is executed.
TIMING	Sets the timing of the operation to execute.	
	<b>AFTER PREVIOUS</b>	The function is executed after the preceding one. The next sequential list number is used.
	SAME AS PREVIOUS	Executes the operation at the same time as the preceding one. The same list number as the previous operation is used.
MOVE THIS FUNCTION	ENTER	Moves the operation being edited and resorts the list.
COPY THIS FUNCTION	ENTER	Copies the operation being edited into a position in the list you desire.
DELETE THIS FUNCTION	EXEC	Deletes the operation being edited.

## 15: SEQUENCER

Menu item	Value (bold text: default value)	Explanation	
LIST EDIT	ENTER	Shows a list of operations recorded in the sequencer. Select an operation or "ADD NEW FUNCTION" and press the [VALUE] knob to show the FUNCTION EDIT menu, where you can edit the operation.	
	<b>Menu item</b>	<b>Value</b>	<b>Explanation</b>
	FUNCTION		Sets the operation to record to the sequencer. * The related menu is shown according to the operation you set.
		PGM TAKE	Switches the final output video.
		PRESET MEMORY	Recalls a preset memory.
		MACRO	Executes a macro (a series of recorded operations).
	NAME	—	Shows the name of the operation.
	EDIT		Sets how naming is done.
		<b>AUTO</b>	Names are automatically given.
		CUSTOM	Names can be assigned as you like. Press the [VALUE] knob to access the screen for editing the name.
	AUTO SEQUENCE		Sets the operation when auto sequence is on.
		PAUSE	Pauses the auto sequence.
		AUTO	Executes the next operation in the sequence.
		1-5-120sec	Executes the next operation after delaying for a specified amount of time.
MOVE THIS FUNCTION	ENTER	Moves the operation being edited and resorts the list.	
COPY THIS FUNCTION	ENTER	Copies the operation being edited into a position in the list you desire.	
DELETE THIS FUNCTION	ENTER	Deletes the operation being edited.	
REPEAT EXECUTE	<b>OFF</b> , ON	When this is "ON," the recorded operation is repeatedly executed.	
INITIALIZE	EXEC	Initializes the sequencer.	
LOAD FROM USB MEMORY	ENTER	Shows a list of the sequence files (.SEQ) that are on the USB flash drive. You can select a sequence file to load the sequencer settings into this unit. The current sequencer settings are overwritten.	
SAVE TO USB MEMORY	ENTER	Shows a list of the sequence files (.SEQ) that are on the USB flash drive. You can select a sequence file to save the current sequencer settings to the USB flash drive. If you selected "NEW FILE..." a new sequence file is saved.	

## 16: STILL IMAGE

Menu item	Value (bold text: default value)	Explanation	
LOAD FROM USB MEMORY	<b>STILL 1-16</b>	Specifies where to save still images imported from a USB flash drive to this unit's internal memory. Press the [VALUE] knob to load the still images. * A "*" symbol is displayed for internal memory where a still image is already saved.	
		<b>Formats supported for loading</b>	
		<b>Format</b>	Bitmap file (.bmp), 24-bit color, uncompressed PNG file (.png), 24-bit color * Alpha channel supported JPEG file (.jpg), 24-bit color
		<b>Resolution</b>	In conformity with system format
	<b>File name</b>	No more than 64 single-byte alphanumeric characters * The extension ".bmp," ".png," or ".jpg" must be added.	
SAVE TO USB MEMORY	<b>STILL 1-16</b>	Selects the still images to export to the USB flash drive. Press the [VALUE] knob to display a list of still images stored on the USB flash drive (in the root directory). Select still images in the list to export them to the USB flash drive. * A "*" symbol is displayed for internal memory where a still image is already saved. * The file formats of the still images that can be saved are the same as in "Formats supported for loading," above. * You can't export still images that were created while "HDCP" in the SYSTEM menu was "ON."	
SAVE TO INTERNAL STORAGE		Use this to set whether to save still images you've captured or loaded to this unit's internal memory.	
	DISABLE	Temporarily saves still images to internal memory. When you turn off the power, the still image is deleted.	
	<b>ENABLE</b>	Saves still images to internal memory.	
DELETE STILL IMAGE	ALL, <b>STILL 1-16</b>	Selects the still images to delete. Press the [VALUE] knob to delete the still images. * An internal memory in which a still image is loaded is indicated by a "*" symbol.	

## 17: FREEZE

Menu item	Value (bold text: default value)	Explanation
FREEZE	<b>OFF</b> , ON	Turns the freeze function on/off. When this is "ON," the input video is temporarily frozen.
TYPE	Specifies the operation mode for freezes.	
	<b>ALL</b>	Freezes all video that is being input.
	SELECT	Freezes only the specified input video.
HDMI 1-8 (*15)	DISABLE, <b>ENABLE</b>	For each input, specifies whether the freeze function is enabled (ENABLE) or disabled (DISABLE).
SDI 1 1-8 (*15)	DISABLE, <b>ENABLE</b>	

(\*15) This can be set if "TYPE" is "SELECT."

## 18: AUTO SWITCHING

Menu item	Value (bold text: default value)	Explanation
AUTO SWITCHING	<b>OFF</b> , ON	Turns the auto switching function on/off. When this is "ON," the video or preset memory are switched automatically.
TYPE	Specifies the operation mode for auto switching.	
	<b>INPUT SCAN</b>	Automatically switches to the video of INPUT 1-10 when the specified interval.
	PRESET MEMORY SCAN	Automatically recalls preset memories 1-30 at the specified interval. The video and audio are switched according to the settings that are saved in each preset memory.
	BPM SYNC	Synchronizes the PGM/A bus and PST/B bus video, so that they switch automatically in sync with the BPM (number of beats per minute) you set.
<b>When TYPE = INPUT SCAN</b>		
SCAN SEQUENCE	Specifies the order in which video signals are shown. * If there is no video input, this is skipped.	
	<b>NORMAL</b>	Switches in the order of INPUT 1 → 10.
	REVERSE	Switches in the order of INPUT 10 → 1.
	RANDOM	Switches randomly.
SCAN TRANSITION TIME (*16)	0.0- <b>1.0</b> -4.0sec	Specifies the video transition time.
SCAN TARGET	Sets the video to which auto switching is applied.	
	<b>PGM/A &amp; PST/B</b>	Final output video and preview video
	PinP & KEY 1-4	PinP and key layer (inset screen) video
INPUT 1-10 TIME	OFF, 1- <b>5</b> -120sec	Specifies the time that the video is shown. Turn this "OFF" to skip.
<b>When TYPE = PRESET MEMORY SCAN</b>		
SCAN SEQUENCE	Specifies the order in which preset memories are switched. * Preset memories in which no settings have been saved are skipped.	
	<b>NORMAL</b>	Switches in the order of preset memory 1 → 30.
	REVERSE	Switches in the order of preset memory 30 → 1.
	RANDOM	Switches randomly.
MEMORY 1-30 TIME	OFF, 1- <b>5</b> -120sec	Specifies the time it takes to switch to the next preset memory. Turn this "OFF" to skip.
<b>When TYPE = BPM SYNC</b>		
BPM	20- <b>120</b> -250	Specifies the BPM (number of beats per minute). If the "BPM TAP" function is assigned to the USER button, you can set the BPM according to the tempo at which you press the button. The button flashes in sync with the current BPM setting.
MODE	Specifies how the video is switched.	
	<b>TRANSITION</b>	The video switches using the currently selected transition effect (mix or wipe).
	CUT	The video switches as a cut.
SPEED	x1/4, x1/2, <b>x1</b> , x2	Specifies the video switching speed as a multiple of the specified BPM.

(\*16) This can be set if "SCAN TARGET" is "PGM/A & PST/B."

## 19: CTL/EXP

Menu item	Value (bold text: default value)	Explanation	
<b>CTL/EXP 1, 2</b>	These settings for the footswitch or expression pedal connected to the CTL/EXP 1, 2 jacks.		
CTL/EXP TYPE	Settings for the devices (footswitch or expression pedal) connected to the CTL/EXP 1, 2 jacks.		
	<b>OFF</b>	Disables the CTL/EXP jack.	
	CTL A & CTL B	Choose this if a footswitch is connected.	
	EXP	Choose this if an expression pedal is connected.	
<b>When CTL/EXP TYPE = CTL A &amp; CTL B</b>			
ASSIGN	Specifies the functions that are assigned to CTL A and CTL B of the footswitch.		
CTL A CTL B	<b>CATEGORY</b>	<b>VALUE</b>	<b>Explanation</b>
	<b>N/A</b>	---	No function is assigned.
	PGM CH SELECT	INPUT 1-10	Switches the PGM/A cross-point buttons.
	PST CH SELECT	INPUT 1-10	Switches the PST/B cross-point buttons.
	AUX CH SELECT	INPUT 1-10	Switches the video sent to the AUX bus.
	INPUT 1-10 ASSIGN	HDMI 1-8, SDI 1-8, STILL 1-16	Changes the video assigned to INPUT 1-10.
	STILL OUTPUT	STILL 1-16	Pauses the normal output, and previews or final outputs a cut of the still image. Press the footswitch again to return to normal output.
	PinP & KEY 1-4 SOURCE	HDMI 1-8, SDI 1-8, STILL 1-16	Switches the video source of the inset screen.
	DSK 1, 2 SOURCE	HDMI 1-8, SDI 1-8, STILL 1-16	Switches the DSK video source.
	SW CONTROL	CUT SW, AUTO SW TRANSITION SW, MODE SW SPLIT 1 SW, SPLIT 2 SW PinP & KEY 1-4 PVW SW PinP & KEY 1-4 PGM SW DSK 1, 2 PVW SW DSK 1, 2 PGM SW AUTO MIXING SW OUTPUT FADE SW USER 1-4 SW	This works the same as when you press the button selected in "VALUE."
	TAKE	▲AUTO TAKE ▼	Automatically switches the PGM/A bus and PST/B bus videos.
		▲CUT ▼	Switches the video between PGM/A bus and PST/B bus as a cut.
	AUDIO INPUT MUTE	AUDIO IN 1-3/4, USB IN, Bluetooth IN, HDMI 1-8, SDI 1-8	Turns the mute function on/off for the input audio.
	AUDIO OUTPUT MUTE	MASTER OUTPUT, AUX, USB OUT	Turns the mute function on/off for the output audio.
	AUDIO INPUT SOLO	AUDIO IN 1-3/4, USB IN, Bluetooth IN, HDMI 1-8, SDI 1-8	Turns the solo function on/off for the input audio.
	VOICE CHANGER SW	AUDIO IN 1, 2	Turns the voice changer on/off.
	REVERB (MOMENTARY)	---	Reverb turns on only while you press the footswitch.
	REVERB (ALTERNATE)	---	Turns reverb on/off.
	OUTPUT FADE	---	The final output video fades out to a black screen.
	LOAD MEMORY	MEMORY 1-30	Recalls a preset memory.
	INPUT SCAN	NORMAL	Each time you press the footswitch, the final output switches from INPUT 1-10 in sequential order.
		REVERSE	Each time you press the footswitch, the final output switches from INPUT 1-10 in reverse order.
	MEMORY SCAN	NORMAL	Each time you press the footswitch, preset memories 1-30 are recalled in sequential order.
		REVERSE	Each time you press the footswitch, preset memories are recalled in reverse order from 30 through 1.
	MACRO EXECUTE	MACRO 1-100	Executes a macro (a series of recorded operations).
	SEQUENCER	MODE ON/OFF, NEXT, PREVIOUS, AUTO SEQUENCE	When the sequencer function is on, this works the same as when you press the button selected in "VALUE."
	GPO (ONE SHOT)	GPO 1-16	Outputs a control signal for 0.5 seconds.
GPO (ALTERNATE)	GPO 1-16	The control signal output is switched on/off with each press of the footswitch.	

## Menu List

Menu item	Value (bold text: default value)	Explanation	
<b>When CTL/EXP TYPE = EXP</b>			
<b>ASSIGN</b>	Specifies the function that is assigned to the expression pedal.		
<b>EXP</b>	<b>CATEGORY</b>	<b>VALUE</b>	<b>Explanation</b>
	N/A	---	No function is assigned.
	<b>VIDEO FADER</b>	<b>FADE</b>	Operates the video fader.
		<b>▲CUT▼</b>	Switches the video between PGM/A bus and PST/B bus as a cut.
	STILL OUTPUT	STILL 1-16	Pauses the normal output, and previews or final outputs a cut of the still image.
	AUDIO INPUT LEVEL	AUDIO IN 1-3/4, USB IN, Bluetooth IN, HDMI 1-8, SDI 1-8,	Adjusts the input volume.
	AUDIO OUTPUT LEVEL	MASTER OUTPUT, AUX, USB OUT	Adjusts the output volume.
	VOICE CHANGER MIX	AUDIO IN 1, 2	Adjusts the balance between the unprocessed voice (0) and the voice processed by the effect (100).
REVERB LEVEL	---	Adjusts the amount of sound that is returned from the reverb (return level).	
<b>EXP CALIBRATE</b>	ENTER	<p>Displays the EXP CALIBRATE screen.</p> <p>Following the direction on the screen, calibrate (adjust) the expression pedal.</p> <p>The first time you use the expression pedal, be sure to execute calibration so that the pedal will operate optimally.</p> <p>In some cases, the expression pedal might no longer be operating optimally because of the passage of time or the conditions of use. In such cases you should also execute expression pedal calibration.</p>	



## 20: RS-232/TALLY/GPO/GPI

Menu item	Value (bold text: default value)	Explanation	
<b>RS-232</b>	These are the settings for transmitting/receiving RS-232 commands.		
RS-232	OFF, <b>ON</b>	When this is "ON," RS-232 commands can be transmitted and received.	
BAUDRATE	9600, 38400, <b>115200</b>	Specifies the communication speed (bps) of the RS-232 connector.	
<b>TALLY/GPO</b>	These are settings for tally signals or control signals that are output from the TALLY/GPIO connector.		
TEMPLATE	<b>HDMI TALLY</b> , SDI TALLY, GPO, HDMI TALLY/GPO, SDI TALLY/GPO	Selects a TALLY/GPO 1–16 settings template. Press the [VALUE] knob to apply the template settings to "TALLY/GPO 1–16."	
TALLY/GPO 1–16	PGM HDMI 1–8, PGM SDI 1–8 PST HDMI 1–8, PST SDI 1–8	Assigns the tally signal to TALLY/GPIO connector pins 1–16. A tally signal is output from the connector pins whenever a cross-point button is selected.	
	GPO 1–16	Assigns the GPO to TALLY/GPIO connector pins 1–16. A control signal is output from the connector pins when you press a USER button or the footswitch, or assign a GPO output function to a GPI pin.	
<b>GPI</b>	These settings assign the functions to the GPI.		
GPI 1–8	When an external control signal is input, the assigned functions are executed.		
	<b>CATEGORY</b>	<b>VALUE</b>	<b>Explanation</b>
	<b>N/A</b>	---	No function is assigned.
	PGM CH SELECT	INPUT 1–10	Switches the PGM/A cross-point buttons.
	PST CH SELECT	INPUT 1–10	Switches the PST/B cross-point buttons.
	AUX CH SELECT	INPUT 1–10	Switches the video sent to the AUX bus.
	INPUT 1–10 ASSIGN	HDMI 1–8, SDI 1–8, STILL 1–16	Changes the video assigned to INPUT 1–10.
	STILL OUTPUT	STILL 1–16	Pauses the normal output, and previews or final outputs a cut of the still image. When a control signal is input again, the signal output returns to normal.
	PinP & KEY 1–4 SOURCE	SDI	Switches the video source of the inset screen.
	DSK 1, 2 SOURCE	SDI	Switches the DSK video source.
	SW CONTROL	CUT SW, AUTO SW TRANSITION SW, MODE SW SPLIT 1 SW, SPLIT 2 SW PinP & KEY 1–4 PVW SW PinP & KEY 1–4 PGM SW DSK 1, 2 PVW SW DSK 1, 2 PGM SW AUTO MIXING SW OUTPUT FADE SW, USER 1–4 SW	This works the same as when you press the button selected in "VALUE."
	TAKE	▲ AUTO TAKE ▼	Automatically switches the PGM/A bus and PST/B bus videos.
		▲ CUT ▼	Switches the video between PGM/A bus and PST/B bus as a cut.
	AUDIO INPUT MUTE	AUDIO IN 1–3/4, USB IN, Bluetooth IN, HDMI 1–8, SDI 1–8	Turns the mute function on/off for the input audio.
	AUDIO OUTPUT MUTE	MASTER OUTPUT, AUX, USB OUT	Turns the mute function on/off for the output audio.
	AUDIO INPUT SOLO	AUDIO IN 1–3/4, USB IN, Bluetooth IN, HDMI 1–8, SDI 1–8	Turns the solo function on/off for the input audio.
	VOICE CHANGER SW	AUDIO IN 1, 2	Turns the voice changer on/off.
	REVERB (MOMENTARY)	---	Reverb turns on only while a control signal is input.
	REVERB (ALTERNATE)	---	Turns reverb on/off.
	OUTPUT FADE	---	The final output video fades out to a black screen.
	LOAD MEMORY	MEMORY 1–30	Recalls a preset memory.
	INPUT SCAN	NORMAL	Each time a control signal is input, the final output switches from INPUT 1–10 in sequential order.
		REVERSE	Each time a control signal is input, the final output switches from INPUT 1–10 in reverse order.
	MEMORY SCAN	NORMAL	The preset memories 1 through 30 are recalled in order each time a control signal is input.
		REVERSE	The preset memories are recalled in reverse order from 30 through 1 each time a control signal is input.
	MACRO EXECUTE	MACRO 1–100	Executes a macro (a series of recorded operations).
	SEQUENCER	MODE ON/OFF, NEXT, PREVIOUS, AUTO SEQUENCE	When the sequencer function is on, this works the same as when you press the button selected in "VALUE."
	GPO (ONE SHOT)	GPO 1–16	Outputs a control signal for 0.5 seconds.
	GPO (ALTERNATE)	GPO 1–16	The control signal output is switched on/off each time a control signal is input.

## 21: LAN CONTROL

Menu item	Value (bold text: default value)	Explanation		
CONFIGURE	MANUAL	Selects how settings are made for the IP address, subnet mask, and default gateway. This is to be configured manually.		
	<b>USING DHCP</b>	The IP address and other information needed for connecting to the network is obtained automatically from the DHCP server of the LAN.		
IP ADDRESS (*17)	---.---.---.---	Specifies the IP address as appropriate for the network to which the unit is connected.		
SUBNET MASK (*17)	---.---.---.---	Specifies the subnet mask as appropriate for the network to which the unit is connected.		
DEFAULT GATEWAY (*17)	---.---.---.---	Specifies the default gateway as appropriate for the network to which the unit is connected.		
NETWORK PASSWORD	ENTER	Displays the NETWORK PASSWORD screen. Set the necessary password for network connection, using four characters. <b>Show password</b>		
		<table border="1"> <tr> <td>Password not set</td> <td>----</td> </tr> <tr> <td>Password set</td> <td>****</td> </tr> </table> <p>* Input the password that's set here when connecting a computer or other device on the same network to access the V-160HD.</p>	Password not set	----
Password not set	----			
Password set	****			
INFORMATION	ENTER	Displays the LAN INFORMATION screen.		
	Displays the following information.			
	<b>Item</b>	<b>Explanation</b>		
	STATUS	Connection status		
	IP ADDRESS	IP address		
	SUBNET MASK	Subnet mask.		
	DEFAULT GATEWAY	Default gateway		
	MAC ADDRESS	MAC address		
QR code	QR code for accessing the Smart Tally settings screen (Web) * Note that the QR code is not shown if the V-160HD is disconnected from the network.			

(\*17) This can be set if "CONFIGURE" is "MANUAL."

## 22: CAMERA CONTROL

Menu item	Value (bold text: default value)	Explanation
CAMERA ID	<b>CAMERA 1</b> –16	Selects the camera to be controlled.
PROTOCOL	N/A, JVC, Panasonic, Canon PTZ, VISCA over IP, PTZOptics, Avonic	Specifies the camera's protocol.
IP ADDRESS	<b>192.168.0.101</b>	Input the camera's IP address.
LOGIN NAME	ENTER	Displays the LOGIN NAME screen. Enter the log-in name needed to connect with the camera when "PROTOCOL" is "JVC."
PASSWORD	ENTER	Displays the PASSWORD screen. Enter the password needed to connect with the camera when "PROTOCOL" is "JVC."
CAMERA PRESET RECALL	<b>PRESET 1</b> –10	Selects a preset in which camera settings are preset. By pressing the [VALUE] knob you can recall a preset from the camera. By assigning a USER button to the camera control function, you can recall presets using the buttons (p. 67).
ALL CAMERAS RECALL	<b>OFF</b>	Recall presets from the camera that is being controlled.
	ON	Simultaneously recall presets from all cameras (CAMERA 1–16).
CAMERA PRESET STORE	<b>PRESET 1</b> –10	This selects the preset in which camera settings will be registered. By pressing the [VALUE] knob you can register the camera settings to a preset. * Presets are saved in the camera itself.
PAN	Adjusts the horizontal position of the camera. When the cursor is located at this value, you can control the camera.	
	LEFT	While you hold down the [VALUE] knob, the camera faces left.
	RIGHT	While you hold down the [VALUE] knob, the camera faces right.
TILT	Adjusts the vertical position of the camera. When the cursor is located at this value, you can control the camera.	
	DOWN	While you hold down the [VALUE] knob, the camera faces up.
	UP	While you hold down the [VALUE] knob, the camera faces down.
SPEED	<b>1</b> – <b>12</b> –24	Adjusts the speed at which the camera changes direction.
ZOOM	Adjusts the camera's zoom position. When the cursor is located at this value, you can control the camera.	
	WIDE (FAST)	While you hold down the [VALUE] knob, the camera zooms-out at high speed.
	WIDE (SLOW)	While you hold down the [VALUE] knob, the camera zooms-out at low speed.
	TELE (SLOW)	While you hold down the [VALUE] knob, the camera zooms-in at low speed.
	TELE (FAST)	While you hold down the [VALUE] knob, the camera zooms-in at high speed.
FOCUS (*18)	Adjusts the focal point of the camera. When the cursor is located at this value, you can control the camera.	
	NEAR	While you hold down the [VALUE] knob, the focus moves closer.
	FAR	While you hold down the [VALUE] knob, the focal point moves farther away.
AUTO FOCUS	OFF, <b>ON</b>	When this is "ON," the focal point is set automatically.
EXPOSURE	<b>MANUAL</b> , AUTO	Specifies the exposure mode.
TALLY CH	<b>HDMI 1</b> –8, SDI 1–8	Specifies the connector from which the camera video is input. When the camera video from the V-160HD is the final output, the camera's tally light is lit.

(\*18) This can be set if "AUTO FOCUS" is "OFF."

## 23: USB MEMORY

Menu item	Value (bold text: default value)	Explanation
RESTORE ALL SETTINGS	ENTER	Shows a list of the setting files (.V16) that are on the USB flash drive. You can select a setting file and restore the settings into the unit. The current settings are overwritten.
BACKUP ALL SETTINGS	ENTER	Shows a list of the setting files (.V16) that are on the USB flash drive. You can select the settings file used to back up the current settings to the USB flash drive. If you selected "NEW FILE...", a new settings file is saved. * Some settings are not saved to the file, such as the "TEST PATTERN" and "TEST TONE" settings in the SYSTEM menu.
FORMAT	EXEC	Formats the USB flash drive.

## 24: SYSTEM

Menu item	Value (bold text: default value)	Explanation	
HDCP (*19)	<b>OFF</b>	Specifies whether HDCP is enabled (ON) or disabled (OFF). Copy-protected (HDCP) video cannot be input.	
	ON	Copy-protected (HDCP) video can be input. HDCP is also added to the video that is output. * Video/audio from the SDI OUT connectors and the USB STREAM port are not outputted.	
FRAME RATE (*19)	60, 59.94, 50Hz	Specifies the frame rate.	
USB OUT (*19)	29.97, 59.94Hz 25, 50Hz	Specifies the frame rate of the USB STREAM port. * The value differs depending on the "FRAME RATE" setting.	
SYSTEM FORMAT (*19)	<b>1080p</b> , 1080i, 720p	Specifies the system format. * The output format of the HDMI OUT 3 connector is fixed at 1080p.	
REFERENCE	Specifies the reference clock of the V-160HD.		
	<b>INTERNAL</b>	The V-160HD's internal clock is used as the reference clock	
	EXTERNAL	A synchronizing signal input via the REFERENCE IN connector is used as the reference clock. Black-burst (frame synchronization), bi-level, and tri-level synchronizing signals are supported.	
	SDI 1-8	A signal input via one of the SDI IN 1-8 connectors is used as the reference clock. The VSYNC (vertical synchronizing) signal output from the V-160HD is synchronized to the VSYNC signal input via SDI.	
CLOCK ADJUST	-1920- <b>0</b> -1920	This adjusts the phase horizontally. Adjust this when output is horizontally out of sync with the operation of other devices using the same clock.	
LINE ADJUST	-1200- <b>0</b> -1200	This adjusts the phase vertically. Adjust this when output is vertically out of sync with or field-shifted from the operation of other devices using the same clock.	
Bluetooth	ENTER	Displays the Bluetooth PAIRING menu.	
	<b>Menu item</b>	<b>Value</b>	<b>Explanation</b>
	Bluetooth	<b>OFF</b> , ON	Turns the Bluetooth function on/off.
	PAIRING	EXEC	Begins pairing with a Bluetooth device.
	STATUS	Displays the Bluetooth connection status.	
		OFF	Bluetooth off
		PAIRING MODE	Now pairing
NOT CONNECTED		Waiting for connection	
CONNECTED	Connected		
PANEL OPERATION	Specifies the operation mode for video transitions.		
	A/B	The video of the bus toward which the video fader is flipped always becomes the final output.	
	<b>PGM/PST</b>	The video on the PGM/A bus is always the final output. Select the preview output video (the video to be output next) for the PST/B bus side.	
EFFECTS TRANSITION SYNC	<b>OFF</b> , ON	Sets whether the PinP/DSK composites are switched on and off in tandem with the video transitions. When this is "ON," the PinP/DSK composition turn on/off in tandem with the video transitions. The composited result that is previewed is sent to final output when transitioning to a different video.	
EFFECTS SPOT	DISABLE, <b>ENABLE</b>	Specifies whether the spot function for the [PVW] and [PGM] buttons is enabled (ENABLE) or disabled (DISABLE). With the spot function, long-pressing the [PVW] or [PGM] button for each layer shows only the layer that is targeted for the operation while the button is pressed.	

(\*19) A change in the setting is not applied until you press the [VALUE] knob to confirm.

Menu item	Value (bold text: default value)	Explanation			
PANEL LOCK	ENTER	Displays the PANEL LOCK menu.			
	Enable (ON) or disable (OFF) the panel lock.				
	<b>Menu item</b>	<b>Value</b>	<b>Explanation</b>		
	ALL SW & VOLUME	<b>OFF</b> , ON	The following settings are turned on/off together.		
	PGM/A 1–10 SW	<b>OFF</b> , ON	PGM/A cross-point [1]–[10] buttons		
	PST/B 1–10 SW	<b>OFF</b> , ON	PST/B cross-point [1]–[10] buttons		
	INPUT ASSIGN SW	<b>OFF</b> , ON	[INPUT ASSIGN] button		
	CUT SW	<b>OFF</b> , ON	[CUT] button		
	AUTO SW	<b>OFF</b> , ON	[AUTO] button		
	MODE SW	<b>OFF</b> , ON	[MODE] button		
	AUX SW	<b>OFF</b> , ON	AUX [1]–[10] buttons		
	MEMORY SW	<b>OFF</b> , ON	MEMORY [1]–[10] buttons		
	MACRO SW	<b>OFF</b> , ON	MACRO [1]–[10] buttons		
	TRANSITION SW	<b>OFF</b> , ON	[TRANSITION] button		
	VIDEO FADER	<b>OFF</b> , ON	Video fader		
	SPLIT BLOCK	<b>OFF</b> , ON	[SPLIT 1] [SPLIT 2] buttons, [PGM/A-CENTER] [PST/B-CENTER] knobs		
	SEQUENCER BLOCK	<b>OFF</b> , ON	Buttons in the SEQUENCER section		
	PinP & KEY 1–4 BLOCK	<b>OFF</b> , ON	Buttons and knobs in the PinP & KEY sections		
	DSK 1, 2 BLOCK	<b>OFF</b> , ON	Buttons and knobs in the DSK sections		
	MONITOR 1–4 SW	<b>OFF</b> , ON	MONITOR [1]–[4] buttons		
	OUTPUT FADE SW	<b>OFF</b> , ON	[OUTPUT FADE] button		
CAPTURE IMAGE SW	<b>OFF</b> , ON	[CAPTURE IMAGE] button			
USER 1–4 SW	<b>OFF</b> , ON	USER [1]–[4] buttons			
AUDIO IN 1–3/4 VOLUME	<b>OFF</b> , ON	AUDIO INPUT LEVEL [1] [2] [3/4] knobs			
AUTO MIXING SW	<b>OFF</b> , ON	[AUTO MIXING] button			
AUX VOLUME	<b>OFF</b> , ON	[AUX] knob			
USB STREAM VOLUME	<b>OFF</b> , ON	[USB STREAM] knob			
MASTER OUTPUT VOLUME	<b>OFF</b> , ON	[MASTER OUTPUT] knob			
AUX LINKED PGM	Specifies whether the same video as the final output is sent to the AUX bus (AUX link).				
	<b>OFF</b>	Use the AUX [1]–[10] buttons to select the video of the AUX bus. When selecting a video that is not assigned to INPUT 1–10, set this in “AUX SOURCE” under the VIDEO ASSIGN menu.			
	AUTO LINK MANUAL LINK	AUX link is enabled, and the same video as the final output is sent to the AUX bus. <b>Temporarily disabling AUX link</b> When you press an AUX [1]–[10] button, the selection of the AUX [1]–[10] button is enabled (lit green). You can select the video you want to send to the AUX bus. <b>Re-enabling AUX link</b> <table border="1" data-bbox="651 1375 1495 1485"> <tr> <td><b>AUTO LINK</b></td> <td>When you operate the [AUTO] button etc. to switch the final output video, AUX link is automatically enabled.</td> </tr> <tr> <td><b>MANUAL LINK</b></td> <td>When you press the AUX [1]–[8] button that is currently selected (lit green), AUX link is enabled.</td> </tr> </table>	<b>AUTO LINK</b>	When you operate the [AUTO] button etc. to switch the final output video, AUX link is automatically enabled.	<b>MANUAL LINK</b>
<b>AUTO LINK</b>	When you operate the [AUTO] button etc. to switch the final output video, AUX link is automatically enabled.				
<b>MANUAL LINK</b>	When you press the AUX [1]–[8] button that is currently selected (lit green), AUX link is enabled.				
CUT SW ASSIGN (*20)	Specifies the function of the [CUT] button.				
	▲AUTO TAKE	When the video of the PST/B bus is selected, switches to the video of the PGM/A bus. The transition time is specified by the TRANSITION TIME menu item “WIPE/MIX TIME.”			
	▲AUTO TAKE▼	Switches the video between PGM/A bus and PST/B bus. The transition time is specified by the TRANSITION TIME menu item “WIPE/MIX TIME.”			
	▲CUT	When the video of the PST/B bus is selected, switches to the video of the PGM/B bus as a cut.			
	▲CUT▼	Switches the video between PGM/A bus and PST/B bus as a cut.			
AUTO SW ASSIGN (*20)	Specifies the function of the [AUTO] button.				
	AUTO TAKE▼	When the video of the PGM/A bus is selected, switches to the video of the PST/B bus. The transition time is specified by the TRANSITION TIME menu item “WIPE/MIX TIME.”			
	▲AUTO TAKE▼	Switches the video between PGM/A bus and PST/B bus. The transition time is specified by the TRANSITION TIME menu item “WIPE/MIX TIME.”			
	CUT▼	When the video of the PGM/A bus is selected, switches to the video of the PST/B bus as a cut.			
	▲CUT▼	Switches the video between PGM/A bus and PST/B bus as a cut.			
OUTPUT FADE ASSIGN	Specifies the function of the [OUTPUT FADE] button.				
	VIDEO FADE	N/A, <b>BLACK</b> , WHITE, AUX			
	AUDIO FADE	DISABLE, <b>ENABLE</b>			
		The final output video is faded-in/out to the specified video.			
		When this is set to “ENABLE,” the output audio also fades in/out along with the video.			

(\*20) This can be set if “PANEL OPERATION” is “A/B.”

Menu item	Value (bold text: default value)	Explanation	
USER SW ASSIGN	ENTER	Displays the USER SW ASSIGN menu.	
	Specifies the function that is assigned to the USER [1]–[4] button.		
	<b>USER SW 1–4</b>		
	<b>CATEGORY</b>	<b>VALUE</b>	<b>Explanation</b>
	N/A	---	No function is assigned.
	FREEZE	---	Turns the freeze function on/off.
	AUTO SWITCHING	AUTO SWITCHING SW	Turns the auto switching function on/off.
		BPM TAP	When “TYPE” in the AUTO SWITCHING menu is “BPM SYNC,” you can set the BPM according to the tempo at which you press the button. The buttons flash in sync with the current BPM setting.
	INPUT ASSIGN	INPUT 1–10	Each time you press a button, the video source assigned to the specified cross-point button switches to the following sources in order: [HDMI 1 → 8] → [SDI 1 → 8] → [STILL 1 → 16].
	STILL OUTPUT	STILL 1–16	Pauses the normal output, and previews or final outputs a cut of the still image.
	AUDIO INPUT MUTE	AUDIO IN 1–3/4 USB IN, Bluetooth IN HDMI 1–8, SDI 1–8	Turns the mute function on/off for the input audio.
	AUDIO OUTPUT MUTE	MASTER OUTPUT AUX, USB OUT	Turns the mute function on/off for the output audio.
	VOICE CHANGER SW	AUDIO IN 1, 2	Turns the voice changer on/off.
	REVERB (MOMENTARY)	---	Reverb turns on only while the button is pressed.
	REVERB (ALTERNATE)	---	Turns reverb on/off.
	INPUT SCAN	NORMAL	Each time you press a button, the final output switches from INPUT 1–10 in sequential order.
		REVERSE	Each time you press a button, the final output switches from INPUT 1–10 in reverse order.
	MEMORY SCAN	NORMAL	Each time you press a button, preset memories 1–30 are recalled in sequential order.
		REVERSE	Each time you press a button, preset memories are recalled in reverse order from 30 through 1.
	REC CONTROL	---	Controls the recorder’s video record start/stop if a recorder that supports REC control functionality is connected.
	GPO (ONE SHOT)	GPO 1–16	Outputs a control signal for 0.5 seconds.
GPO (ALTERNATE)	GPO 1–16	The control signal output is switched on/off while the button is pressed.	
CAMERA CONTROL	---	Turns the camera control function on/off. When this is on, the CAMERA PRESET [1]–[10] buttons can be used to recall the presets.	
Bluetooth CONTROL	---	Turns the Bluetooth function on/off. Long-press the button to begin pairing.	
MONITOR SW ASSIGN	ENTER	Displays the MONITOR SW ASSIGN menu.	
	These settings are for the monitoring video assigned to the MONITOR [1]–[4] buttons.		
	<b>Menu item</b>	<b>Value</b>	<b>Explanation</b>
	MONITOR 1–4 SW	N/A	No video is assigned.
		MULTI-VIEW	The final output video, preview output video and the videos allocated to the cross-point [1]–[8] buttons are shown in sections of the display (multi-view).
		16 INPUT-VIEW	The input video from the HDMI IN connectors and the SDI IN connectors are shown as 16 separate sections on the screen
		16 STILL-VIEW	Shows the loaded still images in 16 separate sections on the screen.
		PROGRAM	Shows the final output video.
		SUB PROGRAM	Shows the SUB PROGRAM bus video.
		PREVIEW	Shows the preview output video.
		AUX	Shows the AUX bus video.
LED DIMMER	1–8	Adjusts the brightness when the buttons or indicators are lit.	
LCD DIMMER	1–8	Adjusts the brightness of this unit’s monitor.	
ON SCREEN MENU	UPPER LEFT, UPPER RIGHT, LOWER LEFT, LOWER RIGHT	Sets where the menu is displayed.	
TALLY FRAME	OFF, ON	Sets whether to display the tally frame or not in the monitor.	

Menu item	Value (bold text: default value)	Explanation												
AUX/SOURCE INDICATOR	OFF, <b>ON</b>	Sets whether to display the AUX/SOURCE indicators in the monitor. 												
			<table border="1"> <thead> <tr> <th>Color</th> <th>Explanation</th> </tr> </thead> <tbody> <tr> <td>Yellow</td> <td>Shows that this has been selected as an inset screen for the PinP &amp; KEY.</td> </tr> <tr> <td>Magenta</td> <td>Shows that this has been selected as a DSK video source.</td> </tr> <tr> <td>Green</td> <td>Shows that this has been selected as an AUX bus video source.</td> </tr> </tbody> </table>	Color	Explanation	Yellow	Shows that this has been selected as an inset screen for the PinP & KEY.	Magenta	Shows that this has been selected as a DSK video source.	Green	Shows that this has been selected as an AUX bus video source.			
Color	Explanation													
Yellow	Shows that this has been selected as an inset screen for the PinP & KEY.													
Magenta	Shows that this has been selected as a DSK video source.													
Green	Shows that this has been selected as an AUX bus video source.													
REC INDICATOR	OFF, <b>ON</b>	Sets whether to display the REC indicator in the monitor. When this is "ON," a REC indicator showing that the camera's REC button has been pressed is displayed, if the unit is connected to a camera that supports the REC status function.												
AUDIO LEVEL METER	OFF, <b>ON</b>	Specifies whether to display the audio level meter in the monitor.												
MASTER OUTPUT	OFF, LEFT, <b>RIGHT</b>	Sets the display position of the audio level meter. When this is "OFF," the level meter is always hidden. * This is displayed in the multi-view.												
AUX	OFF, <b>LEFT</b> , RIGHT													
USB OUT	OFF, <b>LEFT</b> , RIGHT													
AUDIO IN/USB/Bluetooth	<b>OFF</b> , LOWER, UPPER													
MULTI-VIEW LABEL	OFF, <b>ON</b>	Specifies whether to display the label in the monitor.												
AUTO HIDE	OFF, <b>ON</b>	When this is "ON," the label is hidden while the menu is open.												
MULTI-VIEW LABEL EDIT	<b>HDMI 1</b> – 8, SDI 1–8, STILL 1–16, PGM, SUN PGM, PVW	Edit the label name shown in the monitor. Press the [VALUE] knob to access the LABEL EDIT screen.												
MULTI-VIEW LABEL SIZE	SMALL, <b>NORMAL</b>	Specifies the text size of the label shown in the monitor.												
MULTI-VIEW LAYOUT	Specifies the videos to be shown in the PVW section (LEFT) and PGM section (RIGHT) in the multi-view.													
LEFT RIGHT	<b>PROGRAM</b>	Final output video. This is the default setting for "RIGHT."												
	SUB PROGRAM	SUB PROGRAM bus video												
	<b>PREVIEW</b>	Preview output video. This is the default setting for "LEFT."												
	BLACK	Black screen												
HDMI OUT 3 OSD	ENTER	Displays the HDMI OUT 3 OSD menu.												
	Sets whether to show the menu and other display elements in the video output from the HDMI OUT 3 connector.													
	<table border="1"><thead><tr><th>Menu item</th><th>Value</th><th>Explanation</th></tr></thead><tbody><tr><td>ON SCREEN MENU</td><td>OFF, <b>ON</b></td><td>Menu</td></tr><tr><td>TALLY FRAME</td><td>OFF, <b>ON</b></td><td>Tally frame</td></tr><tr><td>LABEL/LEVEL METER/INDICATOR</td><td>OFF, <b>ON</b></td><td>Label, audio level meter, REC/AUX/SOURCE indicator</td></tr></tbody></table>	Menu item	Value	Explanation	ON SCREEN MENU	OFF, <b>ON</b>	Menu	TALLY FRAME	OFF, <b>ON</b>	Tally frame	LABEL/LEVEL METER/INDICATOR	OFF, <b>ON</b>	Label, audio level meter, REC/AUX/SOURCE indicator	
	Menu item	Value	Explanation											
	ON SCREEN MENU	OFF, <b>ON</b>	Menu											
TALLY FRAME	OFF, <b>ON</b>	Tally frame												
LABEL/LEVEL METER/INDICATOR	OFF, <b>ON</b>	Label, audio level meter, REC/AUX/SOURCE indicator												
ON SCREEN MENU	OFF, <b>ON</b>	Menu												
TALLY FRAME	OFF, <b>ON</b>	Tally frame												
AUTO INPUT DETECT	<b>OFF</b> , ON	Turns the auto input detect function on/off. When this is "ON," input is automatically detected, and the video is switched when input from the final output video is interrupted.												
TEST PATTERN	Specifies the test pattern.													
PATTERN	<b>OFF</b> , 75% COLOR BAR, 100% COLOR BAR, RAMP, STEP, HATCH	Selects the test pattern to display.												
MOTION	<b>DISABLE</b> , SLOW, FAST	Specifies the scroll speed of the test pattern.												
TEST TONE	Specifies the test tone.													
LEVEL	<b>OFF</b> , -20– -10–0dB	Adjusts the test tone volume.												
FREQUENCY L	500Hz– <b>1kHz</b> –2kHz	Specifies the frequency of the test tone for the L-channel.												
FREQUENCY R	500Hz– <b>1kHz</b> –2kHz	Specifies the frequency of the test tone for the R-channel.												
VIDEO FADER CALIBRATE	ENTER	Displays the VIDEO FADER SET screen. Following the instructions on the screen, calibrate (adjust) the video fader. In some cases, because of continued use or transport, the video output might not reach 100% even if you flip the video fader all the way upward or downward. Execute video fader calibration in this case as well.												
FACTORY RESET	EXEC	Returns the unit to its factory defaults.												
VERSION	—	Displays the version of the system program.												

## List of Shortcut Keys

You can set the following items without showing a menu.

Menu item	Operation
<b>MIX/WIPE (When mix is selected)</b>	
MIX TYPE	Hold down the [TRANSITION] button and turn the [PGM/A-CENTER] knob
<b>MIX/WIPE (When wipe is selected)</b>	
WIPE TYPE	Hold down the [TRANSITION] button and turn the [PGM/A-CENTER] knob
WIPE DIRECTION	Hold down the [TRANSITION] button and turn the [PST/B-CENTER] knob
WIPE BORDER COLOR	Hold down the [TRANSITION] button and turn the [PGM/A-CENTER] knob while pressing
WIPE BORDER WIDTH	Hold down the [TRANSITION] button and turn the [PST/B-CENTER] knob while pressing
<b>SPLIT 1</b>	
SPLIT TYPE	Hold down the [SPLIT 1] button and turn the [PGM/A-CENTER] knob
<b>SPLIT 2</b>	
SPLIT TYPE	Hold down the [SPLIT 2] button and turn the [PST/B-CENTER] knob

When the shortcut key is operated, the following menu screen is shown.

Menu	Operation
DSK 1	Hold down the DSK 1 [PVW] button and press the [MENU] button
DSK 2	Hold down the DSK 2 [PVW] button and press the [MENU] button
PinP & KEY 1	Hold down the PinP & KEY 1 [PVW] button and press the [MENU] button
PinP & KEY 2	Hold down the PinP & KEY 2 [PVW] button and press the [MENU] button
PinP & KEY 3	Hold down the PinP & KEY 3 [PVW] button and press the [MENU] button
PinP & KEY 4	Hold down the PinP & KEY 4 [PVW] button and press the [MENU] button
SPLIT 1	Hold down the [SPLIT 1] button and press the [MENU] button
SPLIT 2	Hold down the [SPLIT 2] button and press the [MENU] button
MIX/WIPE	Hold down the [TRANSITION] button and press the [MENU] button



## About Rack Mounting

Attaching the included rack-mount angles lets you install the V-160HD in a 19-inch rack.

### Attaching the Rack-Mount Angles

1. Turn off the power to the V-160HD and disconnect the power cord and all connection cables.
2. Use the included mounting screws (three per side) to attach the rack-mount angles.

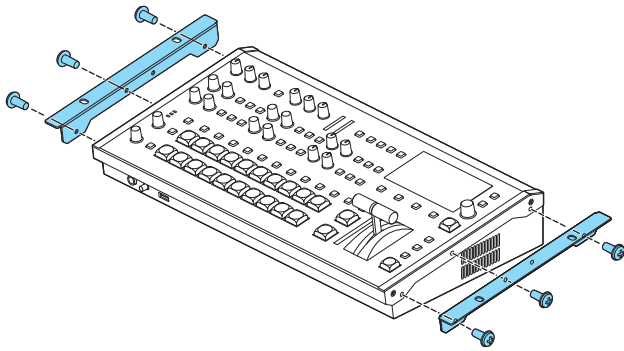

\* Both of the rack-mount angles have the same shape; there is no difference between left and right.

#### NOTE

##### When uninstalling the rack-mount angles

Before uninstalling the rack-mount angles, turn off the power to the V-160HD and disconnect the power cord and all connector cables.

### Important Notes on Rack Mounting

- Before mounting, turn off the power to the V-160HD and detach the power cord and all connection cables.
- When mounting the unit, take care not to pinch your fingers etc.
- To prevent incorrect operation or malfunction, take care not to subject areas protruding beyond the rack to accidental impact.
- To ensure room for connectors and cables, leave 2U of clearance above the unit.
- Use all threaded holes (at 2 locations on each side, for a total of 4) to secure the unit to the rack using screws. Screws for rackmounting are not included.
- Never transport the rack with the unit installed in it. The impact of shaking or vibration might deform the rack-mount angles.
- When mounting the V-160HD in a rack, pay attention to the following points to ensure efficient cooling.
  - Install in a well-ventilated location.
  - Avoid blocking the cooling-fan intake and exhaust ports on the side panels of the V-160HD.
  - Avoid mounting the unit in a sealed-type rack. Warm air within the rack cannot escape, making efficient cooling impossible.
  - If the back of the rack cannot be opened, install an exhaust port or ventilation fan at the top back surface of the rack where warm air collects.
- Also read the "Placement" (the leaflet "USING THE UNIT SAFELY" and the "Startup Guide") under "IMPORTANT NOTES."

# Main Specifications

Video																																																																					
Video Processing	4:2:2 (Y/Pb/Pr), 8-bit																																																																				
Input Connectors	HDMI IN 1-4	HDMI type A x 4 * HDCP supported																																																																			
	HDMI IN 5-8	HDMI type A x 4 * HDCP and multi-format supported																																																																			
	SDI IN 1-8	BNC type x 8 * Conforms to SMPTE 424M (SMPTE 425M-AB), 292M																																																																			
Output Connectors	HDMI OUT 1-3	HDMI type A x 3 * HDCP Supported																																																																			
	SDI OUT 1-3	BNC type x 3 * Conforms to SMPTE 424M (SMPTE 425M-AB), 292M																																																																			
	USB STREAM	USB Type-C®																																																																			
Input formats	HDMI IN 1-4 SDI IN 1-8	<table border="1"> <thead> <tr> <th colspan="2">SYSTEM FORMAT setting: 720p</th> <th colspan="2">SYSTEM FORMAT setting: 1080i or 1080p</th> </tr> <tr> <th colspan="2">FRAME RATE setting</th> <th colspan="2">FRAME RATE setting</th> </tr> <tr> <th>59.94 Hz</th> <th>50 Hz</th> <th>59.94 Hz</th> <th>50 Hz</th> </tr> </thead> <tbody> <tr> <td>720/59.94p</td> <td>720/50p</td> <td>1080/59.94i</td> <td>1080/50i</td> </tr> <tr> <td></td> <td></td> <td>1080/59.94p</td> <td>1080/50p</td> </tr> <tr> <td></td> <td></td> <td>1080/60p</td> <td>1080/25p</td> </tr> <tr> <td></td> <td></td> <td>1080/29.97p</td> <td>1080/25p</td> </tr> <tr> <td></td> <td></td> <td>1080/23.98p</td> <td>1080/23.98p</td> </tr> <tr> <td></td> <td></td> <td>1080/24p</td> <td>1080/24p</td> </tr> </tbody> </table> <p>* The input interlaced video signal is converted to progressive video signal by internal processing.</p>	SYSTEM FORMAT setting: 720p		SYSTEM FORMAT setting: 1080i or 1080p		FRAME RATE setting		FRAME RATE setting		59.94 Hz	50 Hz	59.94 Hz	50 Hz	720/59.94p	720/50p	1080/59.94i	1080/50i			1080/59.94p	1080/50p			1080/60p	1080/25p			1080/29.97p	1080/25p			1080/23.98p	1080/23.98p			1080/24p	1080/24p																															
	SYSTEM FORMAT setting: 720p		SYSTEM FORMAT setting: 1080i or 1080p																																																																		
	FRAME RATE setting		FRAME RATE setting																																																																		
59.94 Hz	50 Hz	59.94 Hz	50 Hz																																																																		
720/59.94p	720/50p	1080/59.94i	1080/50i																																																																		
		1080/59.94p	1080/50p																																																																		
		1080/60p	1080/25p																																																																		
		1080/29.97p	1080/25p																																																																		
		1080/23.98p	1080/23.98p																																																																		
		1080/24p	1080/24p																																																																		
HDMI IN 5-8	<table border="1"> <thead> <tr> <th colspan="4">FRAME RATE setting</th> </tr> <tr> <th colspan="2">59.94 Hz</th> <th colspan="2">50 Hz</th> </tr> </thead> <tbody> <tr> <td>480/59.94i</td> <td>480/59.94p</td> <td>576/50i</td> <td>576/50p</td> </tr> <tr> <td>720/59.94p</td> <td></td> <td>720/50p</td> <td></td> </tr> <tr> <td>1080/59.94i</td> <td>1080/59.94p</td> <td>1080/50i</td> <td>1080/50p</td> </tr> <tr> <td>1080/60p</td> <td></td> <td>1080/25p</td> <td></td> </tr> <tr> <td>1080/29.97p</td> <td>1080/30p</td> <td>1080/23.98p</td> <td>1080/24p</td> </tr> <tr> <td>1080/23.98p</td> <td>1080/24p</td> <td>VGA (640 x 480/60 Hz)</td> <td></td> </tr> <tr> <td>VGA (640 x 480/60 Hz)</td> <td></td> <td>SVGA (800 x 600/60 Hz)</td> <td></td> </tr> <tr> <td>SVGA (800 x 600/60 Hz)</td> <td></td> <td>XGA (1024 x 768/60 Hz)</td> <td></td> </tr> <tr> <td>XGA (1024 x 768/60 Hz)</td> <td></td> <td>WXGA (1280 x 800/60 Hz)</td> <td></td> </tr> <tr> <td>WXGA (1280 x 800/60 Hz)</td> <td></td> <td>SXGA (1280 x 1024/60 Hz)</td> <td></td> </tr> <tr> <td>SXGA (1280 x 1024/60 Hz)</td> <td></td> <td>FWXGA (1366 x 768/60 Hz)</td> <td></td> </tr> <tr> <td>FWXGA (1366 x 768/60 Hz)</td> <td></td> <td>SXGA+ (1400 x 1050/60 Hz)</td> <td></td> </tr> <tr> <td>SXGA+ (1400 x 1050/60 Hz)</td> <td></td> <td>UXGA (1600 x 1200/60 Hz)</td> <td></td> </tr> <tr> <td>UXGA (1600 x 1200/60 Hz)</td> <td></td> <td>WUXGA (1920 x 1200/60 Hz)</td> <td></td> </tr> <tr> <td>WUXGA (1920 x 1200/60 Hz)</td> <td></td> <td></td> <td></td> </tr> </tbody> </table> <p>* The refresh rate is the maximum value of each resolution.                      * Conforms to CEA-861-E, VESA DMT Version 1.0 Revision 11.                      * 1920 x 1200/60 Hz: Reduced blanking                      * The input interlaced video signal is converted to progressive video signal by internal processing.</p>	FRAME RATE setting				59.94 Hz		50 Hz		480/59.94i	480/59.94p	576/50i	576/50p	720/59.94p		720/50p		1080/59.94i	1080/59.94p	1080/50i	1080/50p	1080/60p		1080/25p		1080/29.97p	1080/30p	1080/23.98p	1080/24p	1080/23.98p	1080/24p	VGA (640 x 480/60 Hz)		VGA (640 x 480/60 Hz)		SVGA (800 x 600/60 Hz)		SVGA (800 x 600/60 Hz)		XGA (1024 x 768/60 Hz)		XGA (1024 x 768/60 Hz)		WXGA (1280 x 800/60 Hz)		WXGA (1280 x 800/60 Hz)		SXGA (1280 x 1024/60 Hz)		SXGA (1280 x 1024/60 Hz)		FWXGA (1366 x 768/60 Hz)		FWXGA (1366 x 768/60 Hz)		SXGA+ (1400 x 1050/60 Hz)		SXGA+ (1400 x 1050/60 Hz)		UXGA (1600 x 1200/60 Hz)		UXGA (1600 x 1200/60 Hz)		WUXGA (1920 x 1200/60 Hz)		WUXGA (1920 x 1200/60 Hz)			
FRAME RATE setting																																																																					
59.94 Hz		50 Hz																																																																			
480/59.94i	480/59.94p	576/50i	576/50p																																																																		
720/59.94p		720/50p																																																																			
1080/59.94i	1080/59.94p	1080/50i	1080/50p																																																																		
1080/60p		1080/25p																																																																			
1080/29.97p	1080/30p	1080/23.98p	1080/24p																																																																		
1080/23.98p	1080/24p	VGA (640 x 480/60 Hz)																																																																			
VGA (640 x 480/60 Hz)		SVGA (800 x 600/60 Hz)																																																																			
SVGA (800 x 600/60 Hz)		XGA (1024 x 768/60 Hz)																																																																			
XGA (1024 x 768/60 Hz)		WXGA (1280 x 800/60 Hz)																																																																			
WXGA (1280 x 800/60 Hz)		SXGA (1280 x 1024/60 Hz)																																																																			
SXGA (1280 x 1024/60 Hz)		FWXGA (1366 x 768/60 Hz)																																																																			
FWXGA (1366 x 768/60 Hz)		SXGA+ (1400 x 1050/60 Hz)																																																																			
SXGA+ (1400 x 1050/60 Hz)		UXGA (1600 x 1200/60 Hz)																																																																			
UXGA (1600 x 1200/60 Hz)		WUXGA (1920 x 1200/60 Hz)																																																																			
WUXGA (1920 x 1200/60 Hz)																																																																					
Still Image	Bitmap file (.bmp): Maximum 1920 x 1080 pixels, 24-bit color, uncompressed PNG file (.png): Maximum 1920 x 1080 pixels, 24-bit color JPG File (.jpg): Maximum 1920 x 1080 pixels, 24-bit color * It can be stored up to 16 files in the internal memory. * It can be exported in the USB flash drive. * PNG alpha channel supported.																																																																				

Output formats	HDMI OUT 1–2 SDI OUT 1–3	SYSTEM FORMAT setting	FRAME RATE setting		
			59.94 Hz	60 Hz	50 Hz
		720p	720/59.94p	720/60p	720/50p
		1080i	1080/59.94i	1080/60i	1080/50i
		1080p	1080/59.94p	1080/60p	1080/50p
	HDMI OUT 3	FRAME RATE setting			
		59.94 Hz	60 Hz	50 Hz	
		1080/59.94p	1080/60p	1080/50p	
	USB STREAM	FRAME RATE (USB OUT) setting			
		59.94 Hz	29.97 Hz	50 Hz	25 Hz
1080/59.94p		1080/29.97p	1080/50p	1080/25p	
720/59.94p		720/29.97p	720/50p	720/25p	
640 x 480/59.94p		640 x 480/29.97p	640 x 480/50p	640 x 480/25p	
* Uncompressed format (YUV2) and Compressed format (Motion JPEG) supported.					
Video Effects	Transition	CUT, MIX (DISSOLVE/FAM/NAM), WIPE (8 types), SPLIT (2 types)			
	Composition	PinP x 4 (SQUARE, CIRCLE, DIAMOND), Keyer x 4 (Luminance Key, Chroma Key) DSK x 2 (Luminance Key, Chroma Key, Alpha Key, External Key)			
	Other	Flip horizontal, Flip vertical, Still Image Capture, Still Image Playback Output fade (Audio, Video: WHITE or BLACK), Test pattern output			
<b>Audio</b>					
Audio Processing	Sample rate	24 bits/48 kHz			
Audio formats	USB STREAM (input/output)	Linear PCM, 24 bits/48 kHz, 2 ch			
	Bluetooth (input)	Linear PCM, 24 bits/48 kHz, 2 ch			
	HDMI IN	Linear PCM, 24 bits/48 kHz, 2 ch			
	HDMI OUT	Linear PCM, 24 bits/48 kHz, 8 ch			
	SDI IN	Linear PCM, 24 bits/48 kHz, 2 ch (Conforms to SMPTE 299M)			
	SDI OUT	Linear PCM, 24 bits/48 kHz, 8 ch (Conforms to SMPTE 299M)			
Input Connectors	Analog	AUDIO IN 1–2	Combo type (XLR, 1/4-inch TRS phone), phantom power DC 48 V (unloaded maximum), 14 mA (maximum load)		
		AUDIO IN 3/L, 4/R	RCA phono type		
	Digital	USB STREAM	USB Type-C		
		Bluetooth			
		HDMI IN 1–8	HDMI type A x 8		
	SDI IN 1–8	BNC type x 8			
Output Connectors	Analog	AUDIO OUT	XLR type		
		AUDIO OUT	RCA phono type		
		PHONES	Stereo 1/4-inch phone type		
	Digital	USB STREAM	USB Type-C		
		HDMI OUT 1–3	HDMI type A x 3		
	SDI OUT 1–3	BNC type x 3			
Input Level	AUDIO IN 1, 2	-60– +4 dBu (Maximum: +24 dBu)			
	AUDIO IN 3/L, 4/R	-10 dBu (Maximum: +10 dBu)			
Input Impedance	AUDIO IN 1, 2	9.4 kΩ (ANALOG GAIN 0 < 24 dBu), 74.4 kΩ (ANALOG GAIN ≥ 24 dBu)			
	AUDIO IN 3/L, 4/R	47 kΩ			
Output Level	AUDIO OUT (XLR)	+4 dBu (Maximum: +24 dBu)			
	AUDIO OUT (RCA)	-10 dBu (Maximum: +10 dBu)			
	PHONES	92 mW + 92 mW (32 Ω)			
Output Impedance	AUDIO OUT (XLR)	600 Ω			
	AUDIO OUT (RCA)	1 kΩ			
	PHONES	10 Ω			
Audio Effects	Auto Mixing, Delay, Reverb, High pass filter, Echo canceller, Anti-feedback, Noise gate, De-esser, Compressor, Equalizer Voice changer, Multi-band compressor, Limiter, Test tone output				

■ Others		
Other Connectors	USB MEMORY	USB A type (for USB flash drive)
	USB	USB B type (for remote control)
	RS-232	DB-9 type (male, for remote control)
	TALLY	DB-9 type (female, for TALLY output)
Other Functions	Preset Memory (30 types), Macro Control (100 types), Sequencer Control, Panel lock function, EDID Emulator, Auto Switching Auto Input Detect, Smart Tally, Remote Camera Control, Rec Control	
Bluetooth	Ver 4.2	
	Profile Support	A2DP (Audio), GATT (MIDI over Bluetooth Low Energy)
	Codec	SBC (Support to the content protection of the SCMS-T method)
Display	4.3 inches TFT Color LCD: 480 x 272 dots	
Power Supply	AC Adaptor	
Current Draw	2.5 A	
Power Consumption	55 W	
Operation Temperature	+0 to +40 degrees Celsius +32 to +104 degrees Fahrenheit	
Dimensions	437 (W) x 253 (D) x 103 (H) mm	
	17-1/4 (W) x 10 (D) x 4-1/16 (H) inches	
	480 (W) x 253 (D) x 103 (H) mm	
	18-15/16 (W) x 10 (D) x 4-1/16 (H) inches * When rack-mount angles are fitted.	
Weight (excluding AC adaptor)	3.9 kg	
	8 lbs 10 oz	
Accessories	Startup Guide, Leaflet "USING THE UNIT SAFELY," AC adaptor, Power cord, Rack-mount angle x 2 Rack-mount angle mounting screw x 6	
Options (sold separately)	Footswitch: BOSS FS-5U, FS-6, FS-7 Expression Pedal: EV-5, BOSS FV-500L, FV-500H	

\* 0 dBu = 0.775 Vrms

\* This product is a Class A digital device under FCC part 15.

\* This document explains the specifications of the product at the time that the document was issued. For the latest information, refer to the Roland website.

# Dimensions

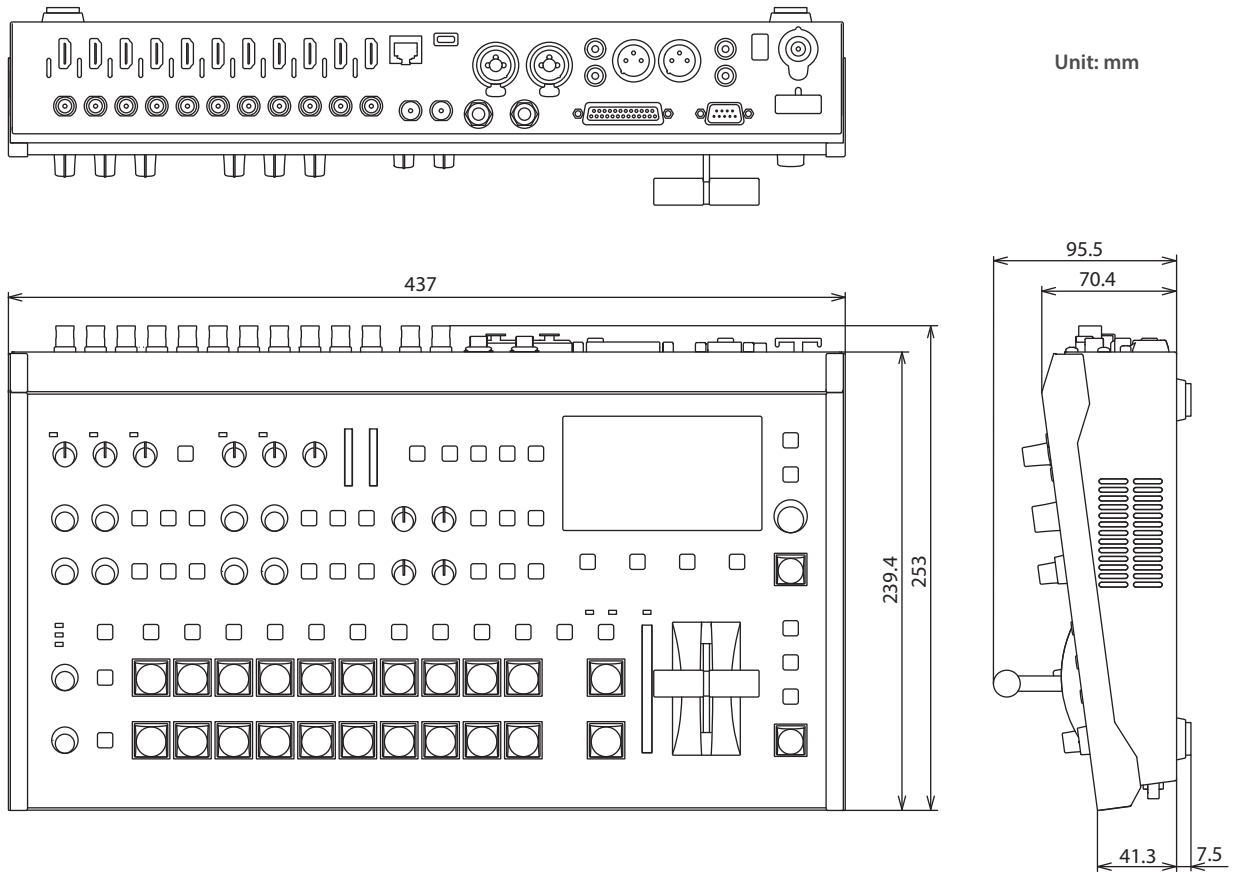

## When rack-mount angles are attached

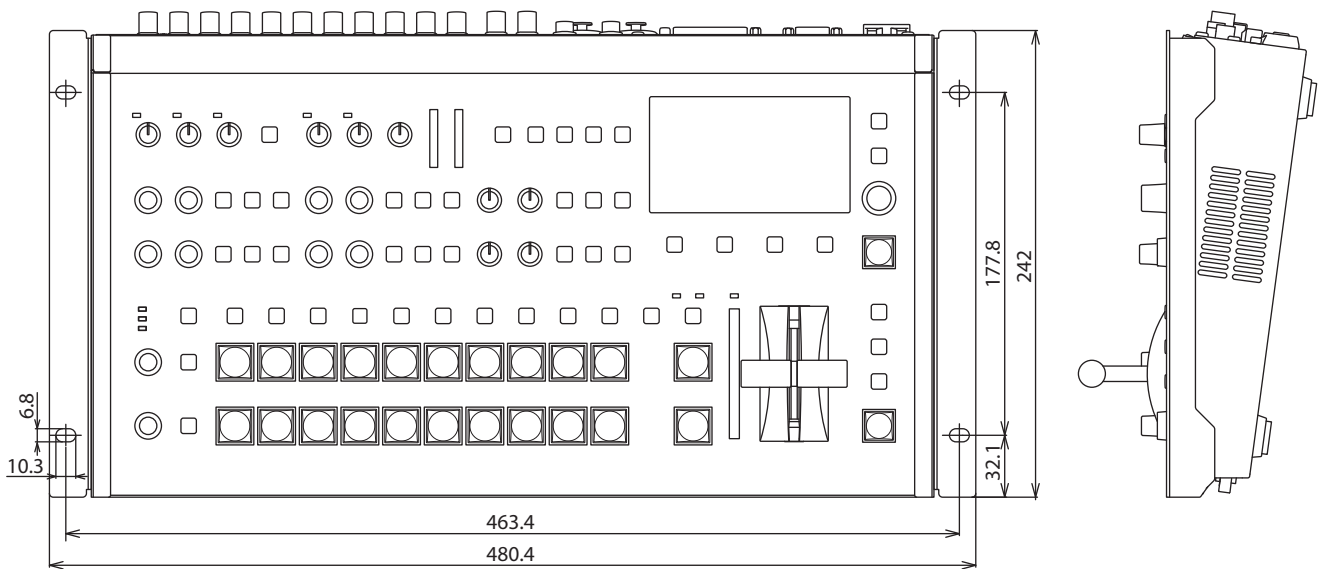

# Video Block Diagram

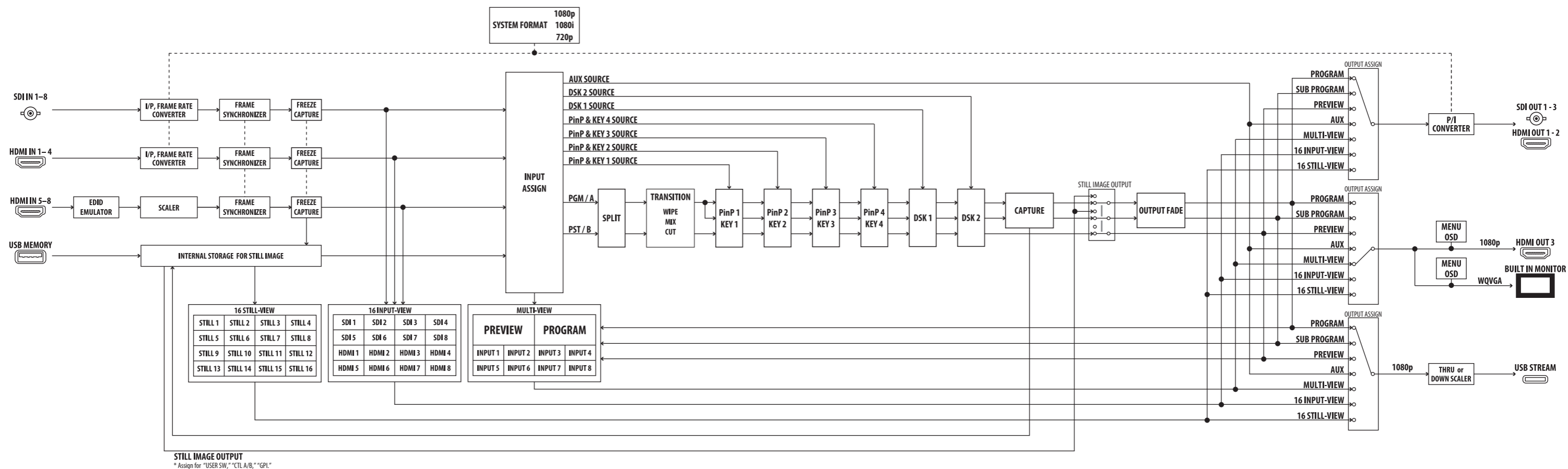

STILL IMAGE OUTPUT  
\* Assign for "USER SW," "CTL A/B," "GPL"

# Audio Block Diagram

