

DN360

OPERATORS MANUAL

Klark Teknik Group,
Klark Teknik Building,
Walter Nash Road,
Kidderminster.
Worcestershire.
DY11 7HJ.
England.

Tel:+44 1562 741515
Fax:+44 1562 745371

Email: sales@ktgplc.com
Website: www.klarkteknik.com

KLARK TEKNIK GROUP

Walter Nash Road, Kidderminster, Worcestershire. DY11 7HJ. England

Tel: (44) (0) 1562 741515. Fax: (44) (0) 1562 745371

Company Registration No: 2414018

KLARK TEKNIK
SIGNAL PROCESSING BY DEFINITION

DDA
BETTER BY DESIGN

MIDAS
DESIGNED FOR A PURE PERFORMANCE

DECLARATION OF CONFORMITY

We, **Klark Teknik Group (UK) Plc**

of, Klark Teknik Building, Walter Nash Road, Kidderminster, Worcestershire, DY11 7HJ

Declare that a sample of the following product:-

Product Type Number	Product Description	Nominal Voltage (s)	Current	Freq
DN360	Graphic Equaliser	115V AC 230V AC	60mA 120mA	50/60Hz

to which this declaration refers, is in conformity with the following directives and/or standards:-

Directive(s)	Test Standard(s)
	UL 813
	CSA 22.2 No1 M90
Low voltage Directive 73/23/EEC	EN 60065
EMC 89/336/EEC amended by 92/31/EEC & 93/68/EEC	EN 50081-1 : 1992
EMC 89/336/EEC amended by 92/31/EEC & 93/68/EEC	EN 55022 Class B
EMC 89/336/EEC amended by 92/31/EEC & 93/68/EEC	EN 50082-1 : 1994
EMC 89/336/EEC amended by 92/31/EEC & 93/68/EEC	ENV 50140/ 8-93
EMC 89/336/EEC amended by 92/31/EEC & 93/68/EEC	ENV 50140/ 2-95
EMC 89/336/EEC amended by 92/31/EEC & 93/68/EEC	EN 5014 1 : 1993
EMC 89/336/EEC amended by 92/31/EEC & 93/68/EEC	EN 60801-2 : 1993
	IEC 801-4/88

Signed:.....

Date: 27th August, 1999

Name: F. D. Merrey Jnr

Authority: Managing Director, Klark Teknik Group (UK) Plc

Attention!

Where applicable, the attention of the specifier, purchaser, installer or user is drawn to special limitations of use which must be observed when these products are taken into service to maintain compliance with the above directives. Details of these special measures and limitations to use are available on request and are available in product manuals.

THANK YOU FOR USING THIS KLARK TEKNIK PRODUCT

To obtain maximum performance from this precision electronic product, please study these instructions carefully. Installation and operating the equaliser is not complicated, but the flexibility provided by its operating features merits familiarisation with its controls and connections. This unit has been prepared to comply with the power supply requirements that exist in your location.

Precautions

Before connecting the unit to the mains power, ensure that the operating voltage is correct for your local supply.

It is important that you observe the following instructions if another voltage setting is required.

Do not install this unit in a location subjected to excessive heat, dust or mechanical vibrations.

Voltage Selection and Power Connection

Connection is made by means of an IEC standard power socket. The rear panel voltage label, indicates the voltage required for satisfactory operation of the unit.

Before connecting this unit to the mains supply, ensure the fuse fitted is the correct type and rating is as indicated on the rear panel, adjacent to the fuse holder.

*Mains voltage change should be carried out by a qualified service technician only.

Safety Warning

This unit is fitted with 3-pin power socket: For safety reasons the earth lead should not be disconnected. Signal 0V is referenced internally to chassis via a resistor capacitor network which provides earth loop immunity.

To prevent shock or fire hazard, do not expose the unit to rain or moisture. To avoid electrical shock do not remove covers. Refer servicing to qualified personnel only.

Attention!

Cables:

This product should only be used with high quality, screened twisted pair audio cables, terminated with metal bodied 3-pin XLR connectors. The cable should be connected to pin 1. Any other cable type or configuration for the audio signals may result in degraded performance due to electromagnetic interference.

Electric Fields:

Should this product be used in an electromagnetic field that is amplitude modulated by an audio frequency signal (20Hz to 20kHz), the signal to noise ratio may be degraded. Degradation of up to 60dB at a frequency corresponding to the modulation signal may be experienced under extreme conditions (3V/m, 90% modulation).

AFTER YOU HAVE UNPACKED THE UNIT

Save all the packing materials - they will prove valuable should it become necessary to transport or ship this product.

Please inspect this unit carefully for any signs of damage incurred during transportation. It has undergone stringent quality control inspection and tests prior to packing and left the factory in perfect condition.

If, however, the unit shows any signs of damage, notify the transportation company without delay. Only you, the consignee, may institute a claim against the carrier for damage during transportation.

If necessary, contact your supplier or as a last resort, your Klark Teknik importing agent, who will fully co-operate under such circumstances.

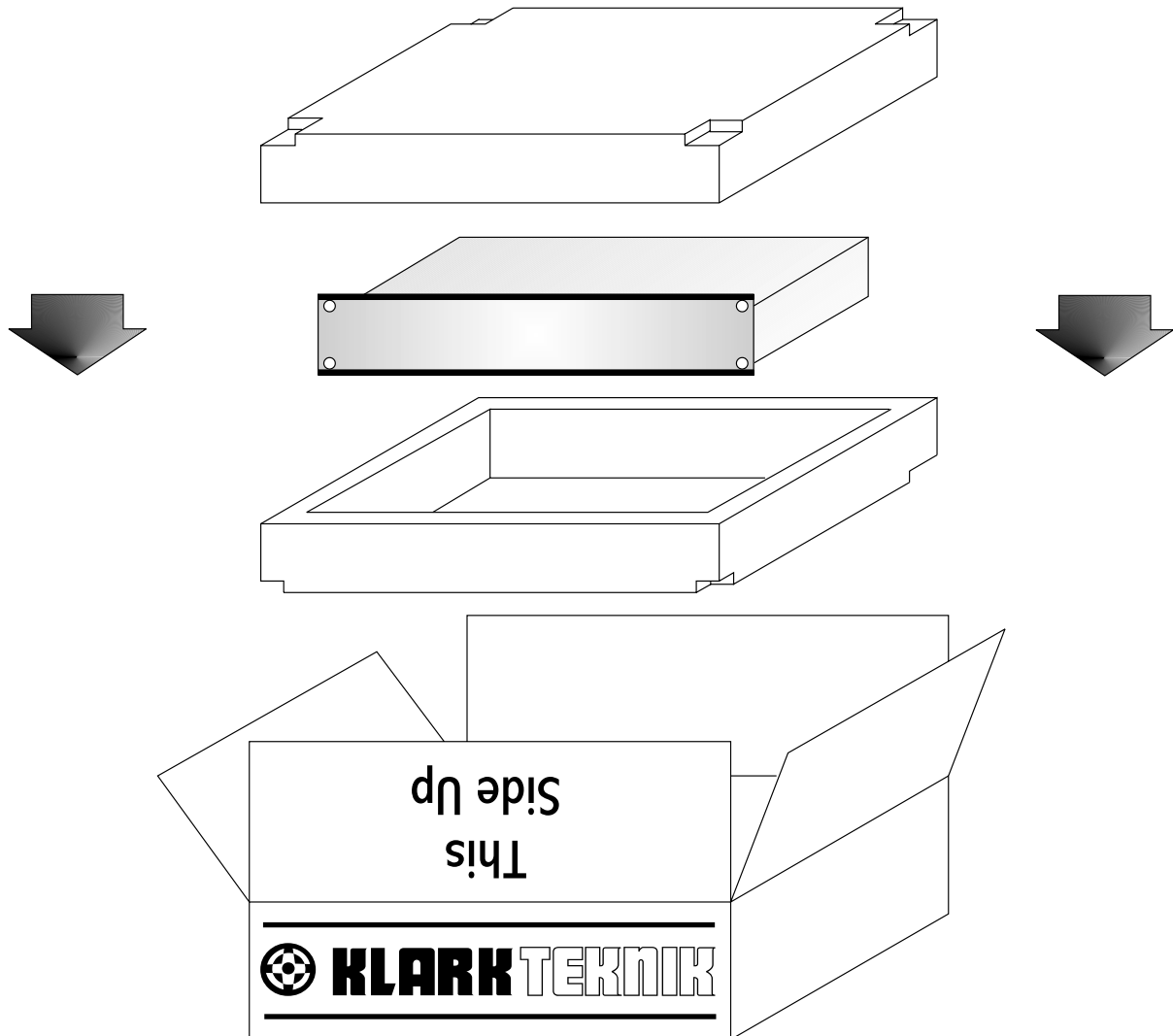

Introduction

The graphic equaliser is a vital component in any audio system. The entire signal passes through it and so any limitations imposed by the equaliser will compromise the performance of the whole system. For example, an indifferently designed equaliser may introduce severe phase distortion, noise and other anomalies related to centre frequency accuracy, filter shape and attenuation accuracy which may manifest themselves as an overall deterioration in the perceived sound quality of the system. Clearly, this is an unacceptable state of affairs, but fortunately your choice to utilise a Klark Teknik graphic equaliser will eliminate these problems, offering you unprecedented product performance coupled with the highest filter calibration and reliability standards in the industry.

For many years Klark Teknik has been at the forefront of equaliser design, and have carried our detailed research into optimum filter response characteristics, including their sonic performance.

The Series 300 range of equalisers is a direct result of this research. It should be noted that graphic equalisation cannot always overcome all frequency response related problems. There are applications where the ability to cut and boost the response at a particular frequency, or over a certain bandwidth other than the equaliser specified one, is required to overcome exceptionally difficult response anomalies or narrow band feedback problems. When such an instance is encountered, it may be more appropriate to use the greater range of control provided by a parametric type equaliser, where the centre frequency, bandwidth and amplitude are all controllable.

Reliability is also of paramount importance which is why our filters are designed around a technique commonly used in computer manufacturing - thick film engineering. This technique has enabled Klark Teknik to build these new filter circuits into self-contained packages which are referred to as "*MELT*". These micro-electronic circuits are so consistent and reliable that we are able to warrant those solid state devices for 5 years. This type of "fit and forget" technology, already proven all over the world, provides users with products that perform brilliantly year after year.

When using an equaliser remember that the need to use large amounts of boost or that within the equalisation curve indicates that there may be something fundamentally wrong with the sound system or room acoustics, which should be further investigated and corrected before final equalisation is applied.

DN360 Graphic Equaliser

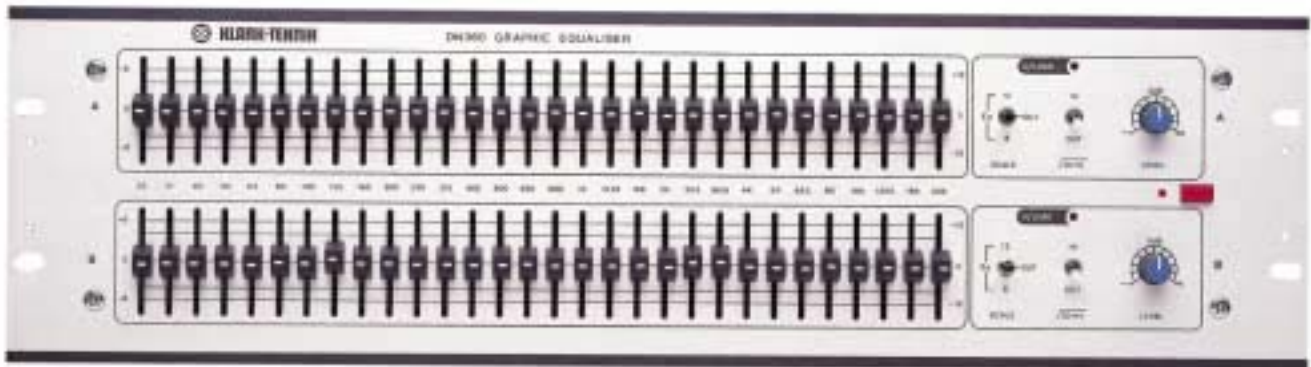

The Klark Teknik DN360 is a dual channel, 30 band equaliser offering 12dB of cut or boost in 1/3 octave steps between the frequencies of 25Hz and 20 kHz.

Filter Shape and Combining Action

ISO CENTRE FREQUENCIES (in Hz)																			
20	31	50	80	125	200	315	500	800	1.25K	2K	3.15K	5K	8K	12.5K	20K				
	25	40	63	100	160	250	400	630	1K	1.6K	2.5K	4K	6.3K	10K	16K				

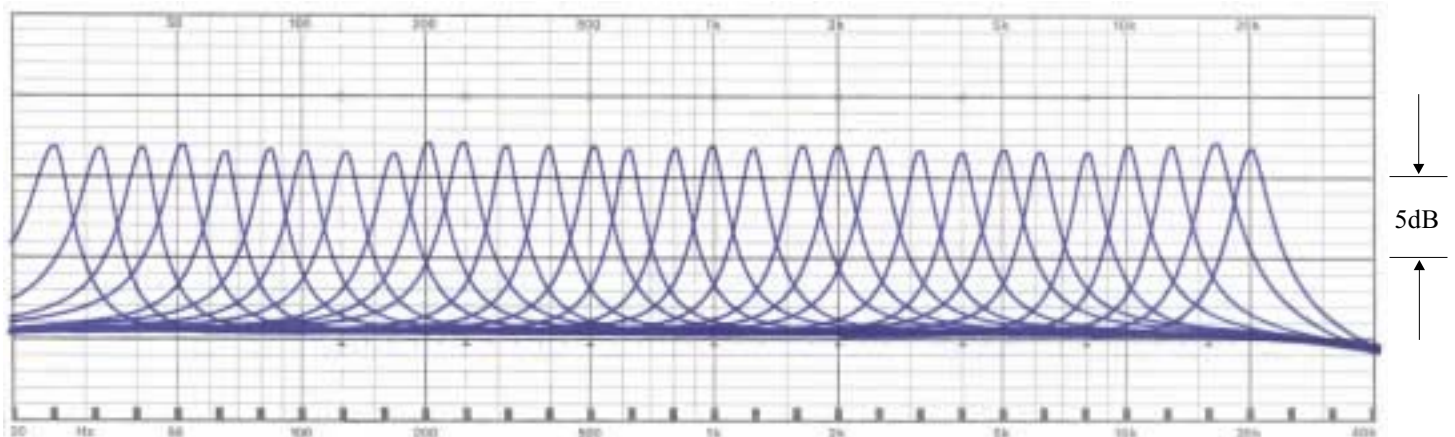

1/3 Octave Band Equaliser Filter Curves

At the heart of any graphic equaliser is the bank of filters used to shape the signal response, and Klark Teknik utilise a proprietary filter circuit which replaces the conventional inductor based circuit, at the same time, offering several performance advantages. Inductor based circuits are heavy, expensive to produce and suffer from low frequency distortion and induced hum. Klark Teknik's proprietary filters on the contrary suffer none of these problems, yet offer unequaled phase response and control accuracy with the additional benefits of low noise and minimal ripple.

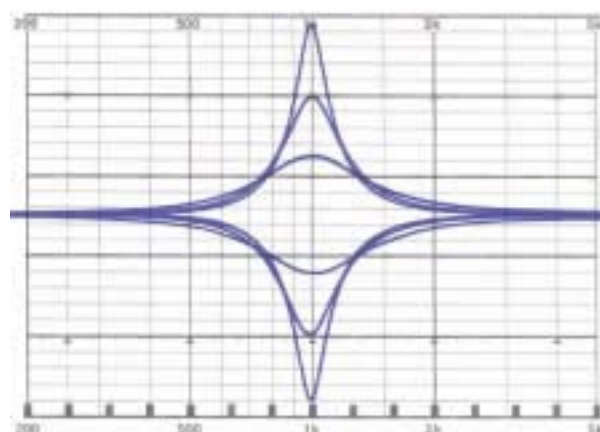

Single Filter Response Curves (1/3 Octave)

The nature, shape and way in which individual equaliser filters combine, has a profound effect on the control provided by the equaliser and on the resulting quality of sound. The majority of applications within the sound reinforcement, broadcast and recording fields, require a smooth and continuous equalisation response curve in order to correctly contour the overall response characteristics of a sound system, loudspeaker, recording effect or audio channel. To achieve this, the individual filters must be capable of combining smoothly together to result in a continuous response curve, free from shape discontinuities in orders to avoid unwanted audible peaks or anomalies in the final sound.



In order to offer operational flexibility a variable fader resolution has been incorporated i.e. 6 or 12 dB cut or boost. This function ("scale") is combined with the bypass switch, which silently removes the graphic equaliser section from the signal path. A subsonic 18dB/octave roll off filter (-3dB @ 3Hz) can be switched in or out from each of the channels.

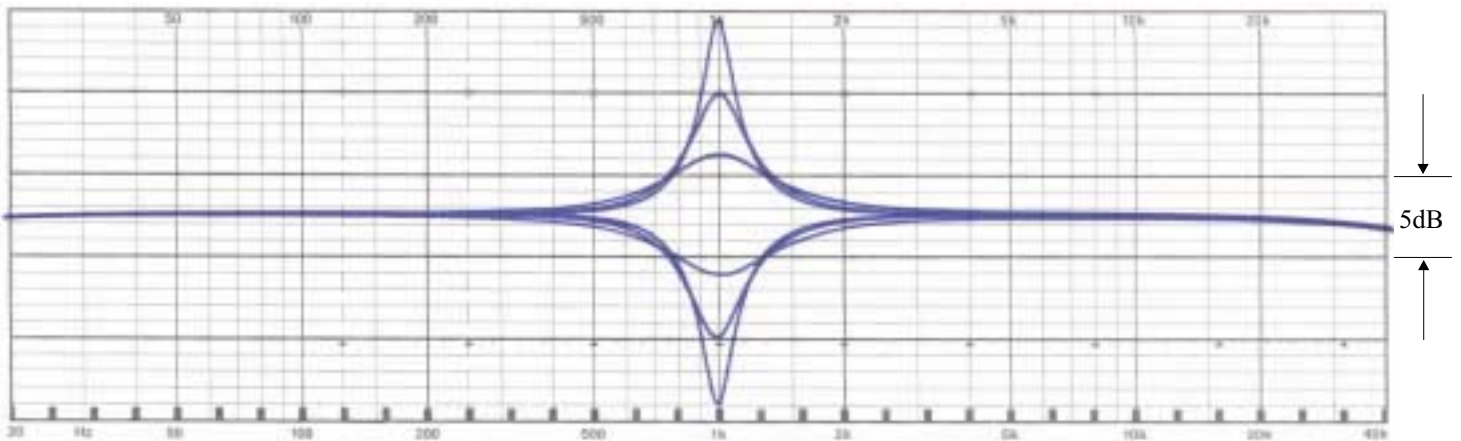

Set of Response Curves for 1/3 Octave Equaliser Filter

Other Features

Other features include an overload LED per channel, which warns of impending overload at any point in the equaliser. A signal-ground lift switch and an optional security cover to prevent unauthorised personnel from tampering with the control settings.

This product is built to the same high electrical and mechanical standards as all Klark Teknik equipment and is both robust and stylish. It occupies a standard three units of rack space and has transformer balanced inputs and outputs.

Reliability Control

Even the advanced technology incorporated in this product, each instrument is given the full backing of Klark Teknik's "**reliability control**" which proves each product against a specification consistent with the highest professional standards. Only top quality components are used, and every unit is bench tested and aligned before a burn-in period and final performance test.

Options

Aluminium security cover
Perspex security cover

Part number: SCA360
Part number: SCP360

Instrument Familiarisation

Front Panel Functions

The high quality faders used in this equaliser have an oil-damped action for smooth operation and feature a centre detent following accurate "flat" setting.

The scale switch selects maximum boost and cut for the equaliser of either 6dB or 12dB. The centre position of this switch performs the **bypass** function, which silently removes the graphic equaliser section from the signal path.

The power switch is a two pole type, isolating both the live and neutral conductors. When the power is on, a red status LED lights.

The input level control allows the system gain to be up to +6dB when in its fully clockwise position, and offers full attenuation in its anti-clockwise position.

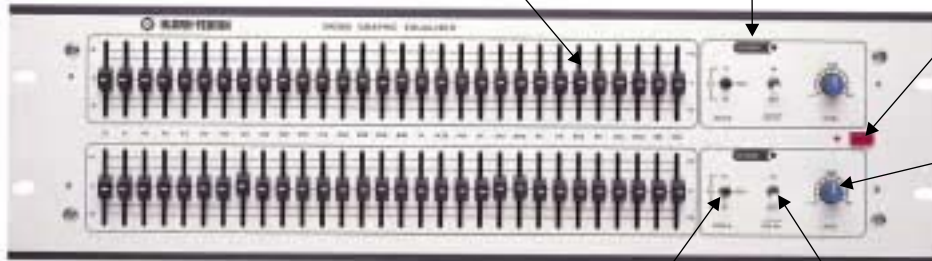

The Overload LED The signal level is monitored at several separate points within the circuitry of the unit, and any one of these signals exceeding a threshold, set 3dB below clipping, will cause the LED to light. This threshold is set at +19dB, but it must be remembered that excessive boost of some frequencies combined with a high average input signal, can occasionally cause this level to be exceeded. In this event, the input level control should be turned down to correct the problems. However, if the input signal itself exceeds +19dBu the input stage will be overloaded. If this problem arises, the signal level from the output of the preceding piece of equipment must be turned down.

Low cut filter switch enables a 30Hz subsonic filter to be connected in or out of circuit.

Rear Panel Functions

The mains fuse is located in a fuse holder, fitted to the rear panel. Always replace with the correct type and rating of fuse, as indicated adjacent to the fuse holder.

Input and output connections are made via complementary XLR style sockets.

Main is supplied via an IEC standard 3 pin connector. A compatible power cable is supplied with the unit.



The serial number of this unit should be quoted in any correspondence concerning the unit.

Audio Connections

Input

The input circuitry is a transformerless, electronically balanced design which achieves a symmetry of better than -50dB from 20Hz to 10kHz.

If transformer balancing of the input is required, this must be stipulated at the time of order; it is not retro-fittable.

Output

The standard output is unbalanced, but balancing transformers are available and may be retrospectively fitted. The output circuitry is capable of driving a 600 ohm load at a level of +22dBm.

Input

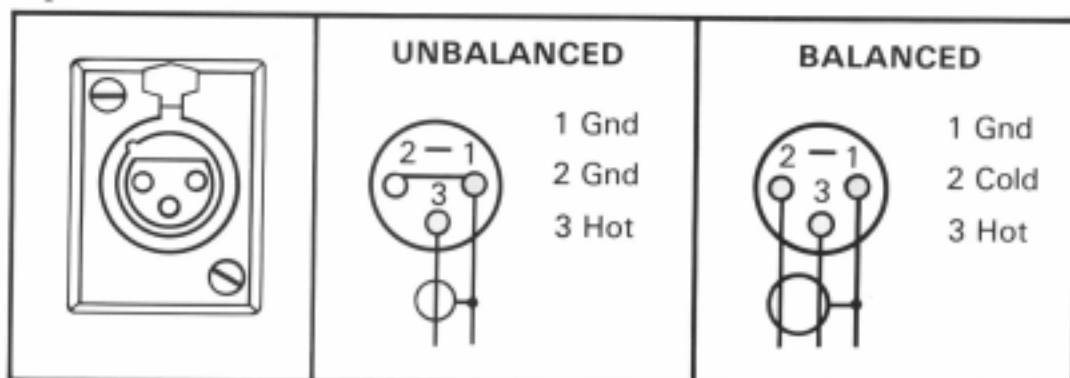

Output

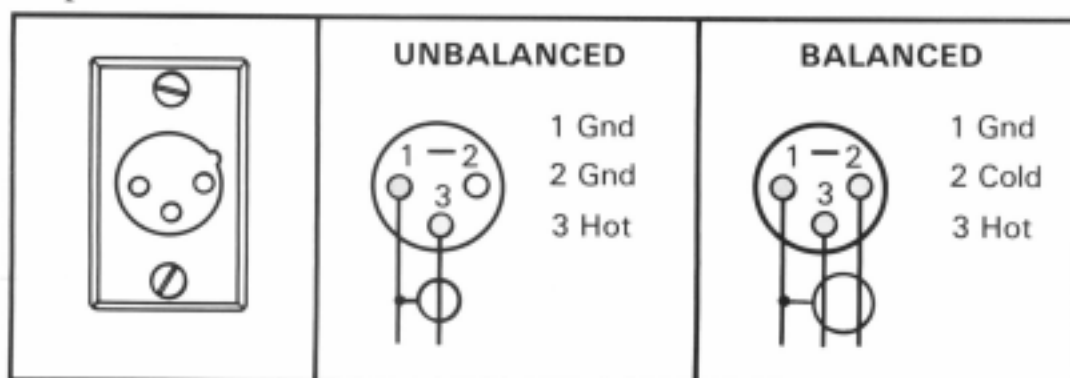

Note: When using a fully balanced system, either pin 2 or pin 3 may be the HOT terminal.

Balanced Circuits

Transformer or electronically balanced connections have the benefit of "common mode rejection" which eliminates externally induced interference such as mains hum etc. Balancing is especially useful when long cable runs are used between pieces of equipment.

Transformer balanced circuits have the added advantage of being, "fully floating" with the ground (earth) or screen being totally isolated from the signal. In installations where a difference in earth potential is likely to occur this isolation prevents grounding problems which can, in some cases, damage the equipment.

Specifications

Input

Type	Transformer balanced
Impedance (balanced)	20k
Unbalanced	10k

Output

Type	Transformer balanced
Min. Load impedance	600
Source impedance	
Max. Level	dBu

Performance

Frequency response	± 0.5 dB(20Hz-20kHz)
Distortion (@ +4dBm)	<0.01% @ 1kHz
Equivalent input noise	<-90dBu (20Hz-20kHz unweighted)
Channel separation	>75dB @ 1kHz
Overload indicator	+19dBu
Level Control	+6dB to -

Filters

Type	*MELT
Centre frequencies	2 x 30
ISO	25Hz - 20kHz 1/3 octave
Tolerance	$\pm 5\%$
Maximum boost/cut	$\pm 6/12$ dB
Subsonic filter	18dB/octave - 3dB @ 30Hz

*MELT - Proprietary Microcircuit

Power Requirements

Voltage	110/120/220/240V 50/60Hz
Consumption	<15VA

Weight

Nett	5Kg
Shipping	6Kg

Dimensions

Width	482mm (19")
Depth	205mm (8")
Height	133mm (5 1/4")

Terminations

Input	3 pin XLR
Output	3 pin XLR
Power	3 pin ICE

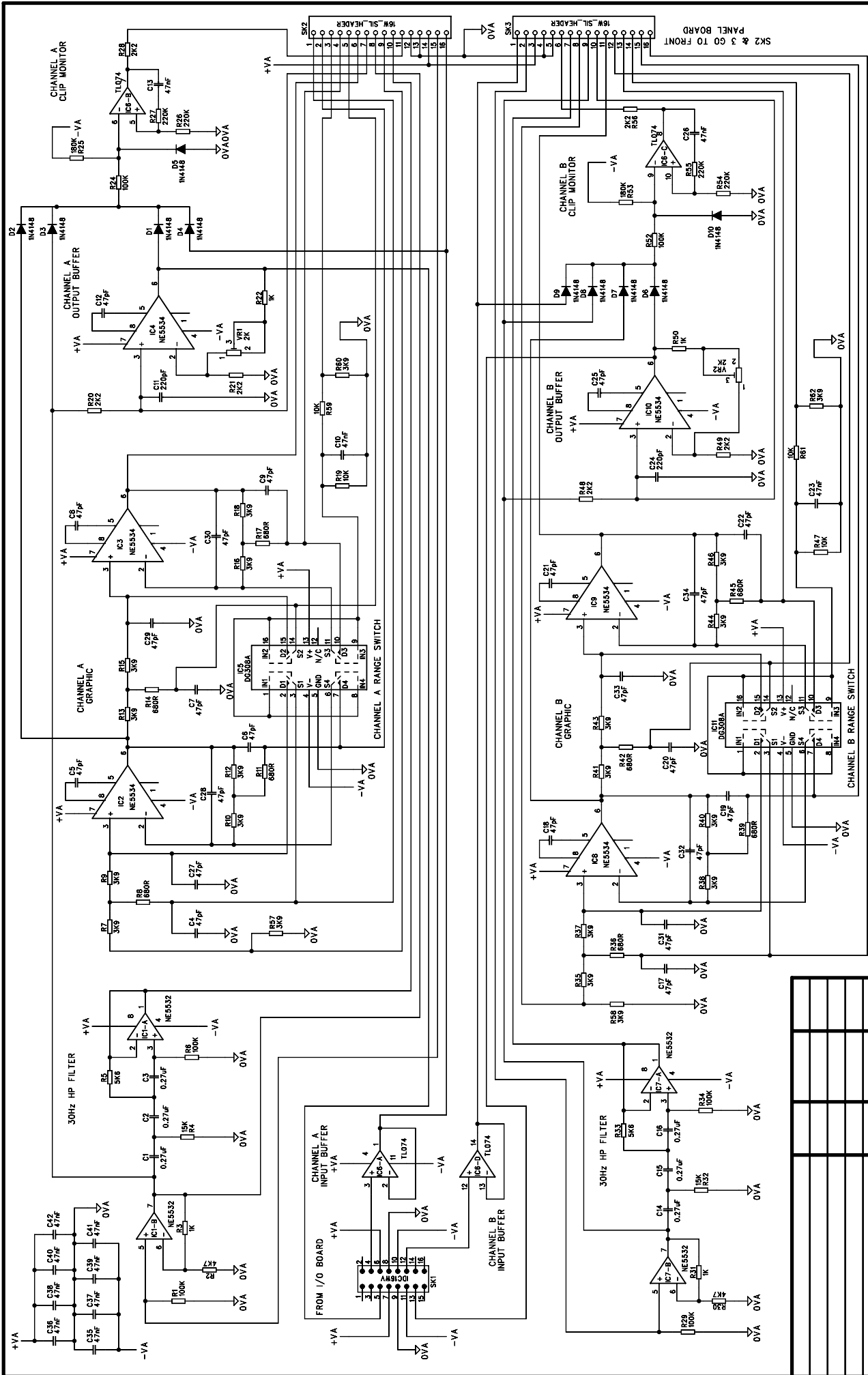

UNIT: DN360		Klark Teknik Group (UK) Plc	
TITLE: DN360 CORE		DRAWN: KP/JC	
BOARD No. DN360_01-2		DATE: 29/4/99	
ISS.		SHEET Iss.: 2	
2		SHEET 1 OF 3	
2		DRG No. B2609	
KAP		CHECKED:	
JRC		BOARD Iss.2	
29/4/99		DATE:	
22/10/97		DATE:	
Re-draw into Pads		AMENDMENTS	
16.11.23 10.09			

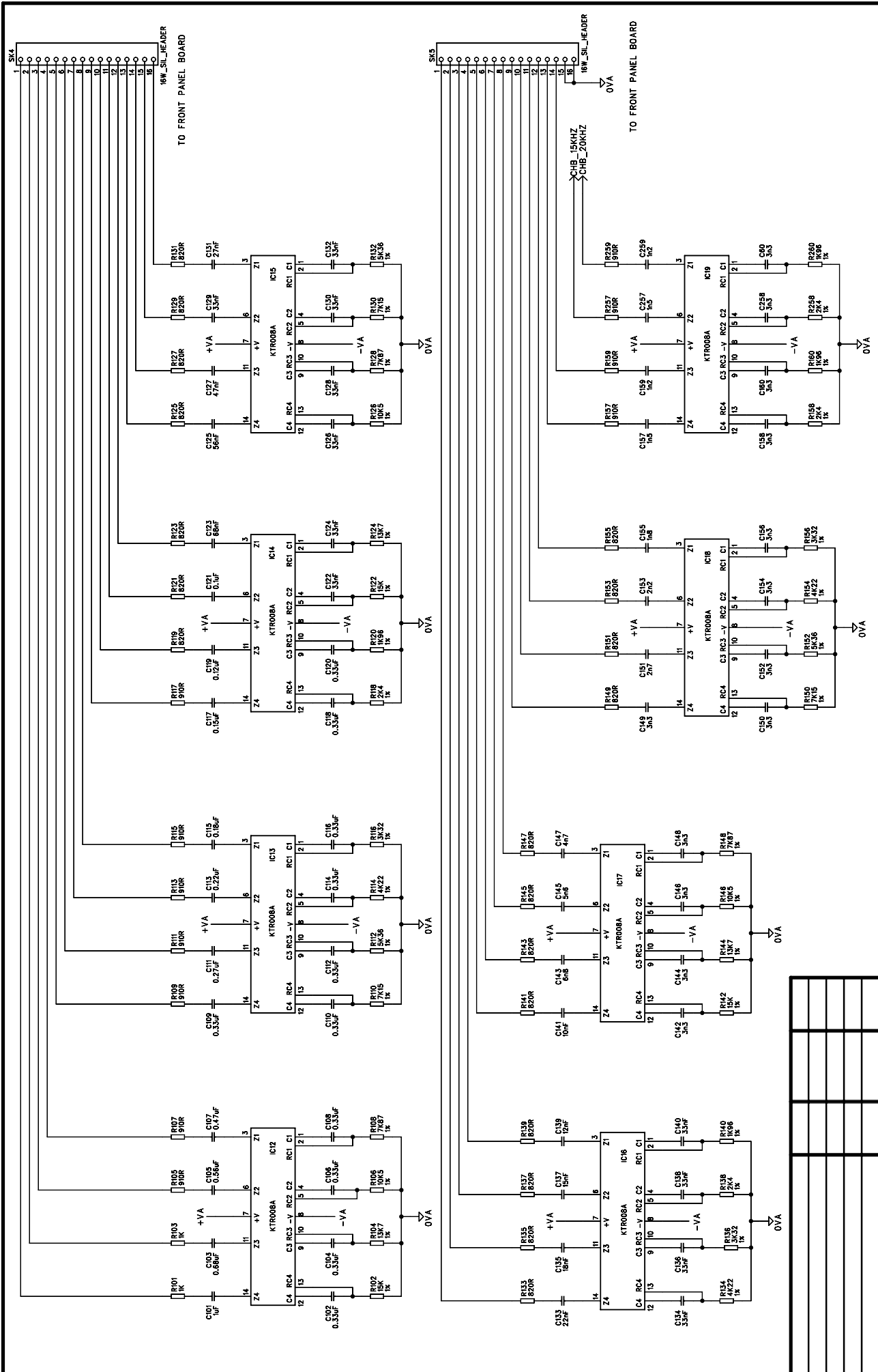

UNIT: DN360		Klark Teknik Group (UK) Plc	
TITLE: DN360 CHANNEL A FILTERS		DATE: 29/4/99	SHEET: 2 OF 3
BOARD No. DN360_01-2		CHECKED:	SHEET Iss: 2
DRAWN: KP/JC		DRG No. B2609	
Drawing details amended		2	KAP
Re-drawn into Pads		2	JRC
AMENDMENTS: 16.11.24.1999		ISS.	INIT.

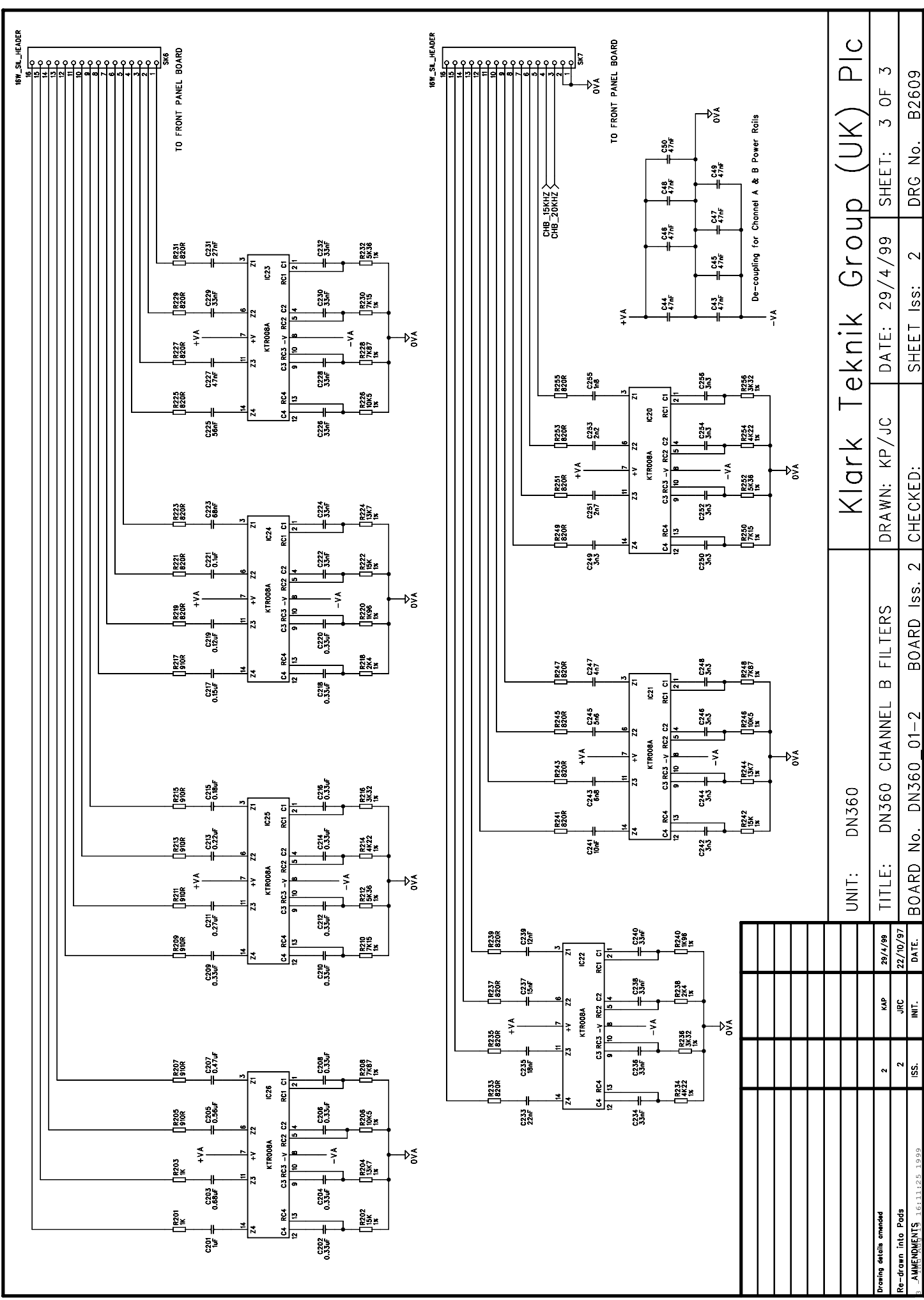

UNIT: DN360		Klark Teknik Group (UK) Pic	
TITLE: DN360 CHANNEL B FILTERS		DATE: 29/4/99	SHEET: 3 OF 3
BOARD No. DN360_01-2		BOARD Iss. 2	CHECKED:
2	KAP	29/4/99	
2	JRC	22/10/97	
	ISS.	INIT.	DATE.
Drawing details amended			
Re-drawn into Pads			
AMENDMENTS			

The Use of Graphic Equalisers

Equalisers may be used for corrective or creative purposes and the Klark Teknik DN360 is applicable in both live sound and studio applications.

For studio use, a pair of 1/3 octave equalisers might typically be used to compensate for deficiencies in the control room acoustics and in this instance, the precision allowed by 30 bands is a great advantage. Because it is almost impossible to set up an equaliser accurately without first analysing the room response, the centre frequencies of the filters have been chosen to correspond with those of the Klark Teknik spectrum analyser, the DN6000. In this way the readings can be transferred directly from the analyser to the equaliser.

It must be stressed however that even a good equaliser doesn't offer a complete solution where the room has severe, inherent acoustic problems. For example, standing waves and resonances cannot be made to disappear simply by using equalisation. True their effects can be reduced, but in a critical listening environment such as a studio control room or concert hall, efforts must be made to minimise these problems at source before equalisation is employed. Also, equalisation cannot overcome the lack of sound clarity caused by rooms with unduly long reverberation times though they may be able to effect some improvement in the intelligibility.

On the other hand, the sound company who may well have to set up in different venues night after night have little or no control over the acoustics of the buildings and so have to use equalisers to arrive at a compromise solution. Depending on the room, some compromises will be more successful than others. Again, effective use of the equaliser means employing the services of a spectrum analyser. It is however not always desirable to achieve a dead flat room response. For example, applying substantial amounts of bass boost to try and restore a weak bottom end is going to use up large amounts of amplifier power and the extra loudspeaker cone excursions so caused will rob the system of headroom and may cause distortion. The harmonics produced by an amplifier driven into clipping may also damage the high frequency drivers and will at any rate sound unpleasant

Therefore, reducing the low frequency output may produce real advantages by way of improved intelligibility and subjective naturalness and this is particularly true of buildings made from concrete or stone where much of the bass is reflected rather than absorbed. Equally, rolling off the high frequency end above 5kHz may also contribute to a more natural sound. The resulting house curve then is far from flat but may will be the ideal compromise. Depending on the individual sound system and the environment, the shape of the optimum house curve will vary and a degree of experience is needed in order to achieve the best results. It should also be borne in mind that the ideal house curves for pure speech and music will not be the same.

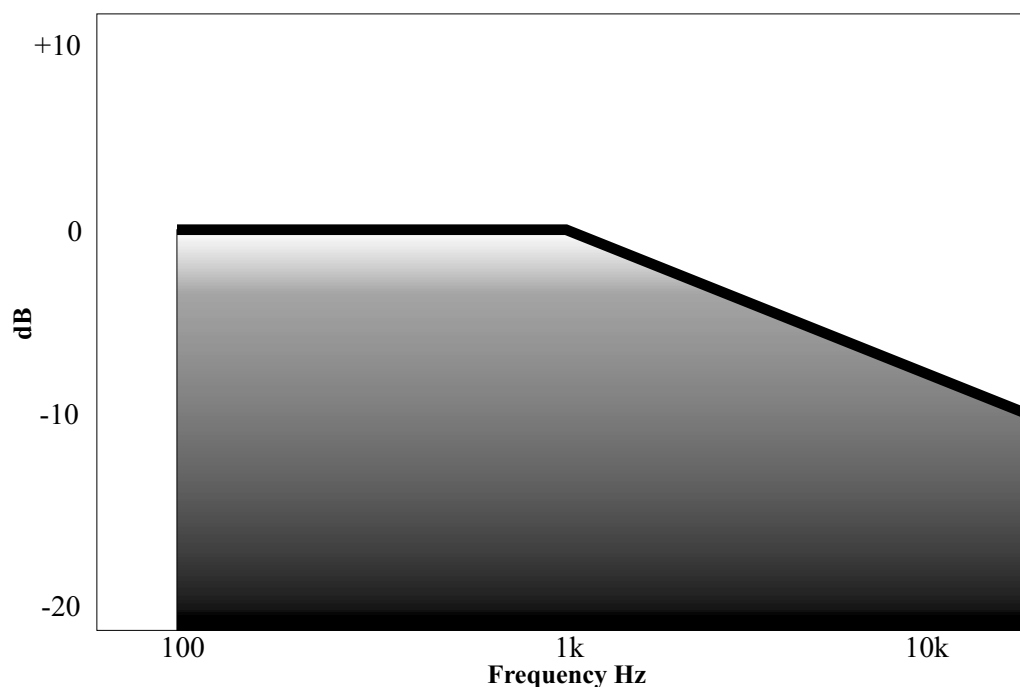

Typical House Curve

In live sound applications, graphic equalisation is almost always applied separately to the stage monitor of foldback system to reduce the level of those frequencies that would otherwise cause feedback problems. These problems came about due to peaks in the frequency response curves of the monitor speaker systems, monitor positioning, and sound reflected from the stage walls. An analyser is probably best employed to do this effectively but many experienced engineers rely on their ears.

In addition to compensating for room acoustics, equalisation can also be used to counteract some of the problems caused by microphone characteristics and positioning or to tailor the response to improve speech intelligibility. Also, many speaker systems have a far from flat response, particularly mobile systems that have to be positioned in physically convenient places rather than the acoustically ideal ones. When equalising the room, these deficiencies are also catered for to a large extent.

Whatever the application, it is generally better to try to attenuate peaks rather than to attempt to boost the surrounding frequencies to the same level, Furthermore, all peaks can be reduced by attenuating their respective band but some response dips simply cannot be corrected. An example is crossover cancellation where very deep notches may appear covering two or three bands. Attempting to level the response by excessive boosting will simply eat up system power and achieve no useful result. Ultimately a dip in the response is not so audibly objectionable as a peak and so it may be as well to leave these dips alone or to try and solve the problem at source by checking your crossover systems and horn alignment.

In broadcast studios, graphic equalisers are often used during phone-in shows to help compensate for the restricted bandwidth of telephone lines. No equaliser can completely correct the signal in this way as it is impossible to boost frequencies that don't exist and telephone lines have a very restricted bandwidth. Nevertheless, the improvement in subjective terms can be dramatic.

Creative uses may include studio work, live or recorded drama and film soundtrack recordings. Voices may be harshly filtered to simulate telephone conversation or the tonal characteristics of an instrument may be modified to fit in with a particular mix.

Though other types of equaliser can often do this job, the graphic equaliser is still the easiest to set up and the controls give an instant visual presentation of the response curve. In the commercial studio where time is often of the essence, this attribute should not be overlooked.

Table 1: Effects of Equalisation on Voice Reproduction

1/3 Octave centre frequency (Hz)	Effect on voice
40, 50, 63, 80, 100, 125,	Sense of power in some outstanding bass singers.
160, 200, 250,	Voice fundamentals.
315, 400, 500	Important for voice quality.
630, 800, 1k	Important for voice naturalness. Too much boost in the 315 to 1k range produces a telephone like quality.
1.25 to 4k	Vocal fricatives - accentuation of vocals. Important to speech intelligibility. Too much boost between 2 and 4kHz can mask certain speech sounds e.g “m”, “b” and “v” can become indistinguishable. Too much boost anywhere between 1 and 4kHz can produce “listening fatigue”. Vocals can be highlighted by slightly boosting the vocal at 3kHz and at the same time slightly dipping the instruments at the same frequency.
5, 6.3, 8k	Accentuation of voice. The range from 1.25 to 8k governs the clarity of voice.
10, 12.5, 16k	Too much boost causes sibilance.

Table 2: Effects of Equalisation on Music Reproduction

1/3 Octave centre frequency (Hz)	Effect on music
31, 40, 50, 63	Fundamentals of bass drum, tuba, double bass and organ. These frequencies give music a sense of power. If over-emphasised they make the music “muddy”. 50 or 60Hz band also used to reject ac. Mains hum.
80, 100, 125	Fundamentals of lower tympani. Too much boost produces excessive “boom”. 100 or 125Hz also used for hum rejection.
160, 200, 250	Drum and lower bass. Too much boost produces excessive “boom”. Also useful for 3rd harmonic mains hum rejection.
315, 400, 500	Fundamentals of string and percussion.
630, 800, 1k	Fundamentals and harmonics of strings, keyboards and percussion. Boosting the 600 - 1kHz range can make instruments sound horn like.
1.25 to 4k	Drums, guitar accentuation of vocals, strings and brass. Too much bass in the 1 to 2kHz range can make instruments sound tinny. Too much boost anywhere between 1 to 4kHz can produce “listening fatigue”.
5, 6.3, 8k	Accentuation of percussion, cymbals and snare drum. Reduction at 5kHz makes overall sound more distant and transparent. Reduction of tape hiss and system noise. The 1,25 to 8k governs clarity and definition.
10, 12.5, 16k	Cymbals and overall brightness. Too much boost causes sibilance. Reduction of tape hiss and system noise.

Equalising a Sound System

When equalising a sound system you should always remember just what it is you are trying to achieve. Two fundamental reasons for equalization are:-

1. To increase the potential gain or power output of the system before feedback.
2. To improve the naturalness or intelligibility of the sound system.

In a space with poor acoustics or high levels of background noise, the most natural sound may well not be the most intelligible - a compromise must therefore be reached between these two qualities depending on the particular application in question - but at the end of the day it doesn't matter how natural the system sounds if no one can understand the sound it puts out!

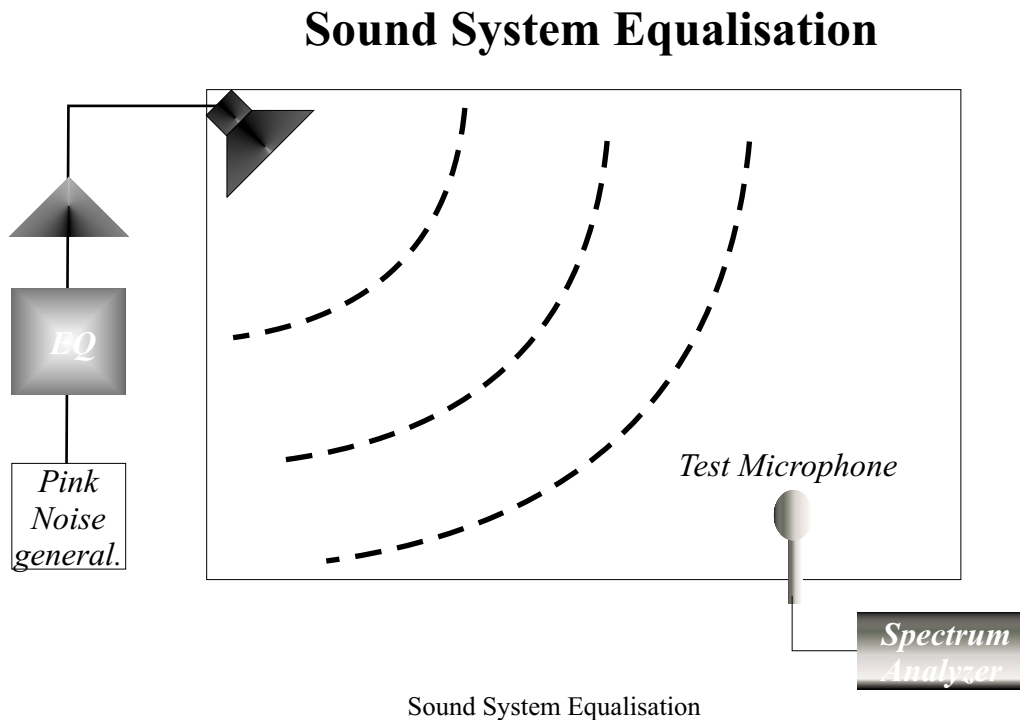

Before beginning to equalise a system, it is a good practice to listen to the “raw” system with speech or music programme. If such signals are distorted then stop and rectify them before attempting to equalise. Another good pre-equalisation test is to use a slow sine-sweep. This can expose a number of problems such as rattles or distortion or poorly controlled room modes and resonances - which pink noise RTA cannot discover. Finally, before equalisation, check the coverage of the system over the 2 to 4kHz bank. (If necessary, use the equaliser as a band pass filter to produce the desire range). If coverage is poor to begin with then no amount of equalisation will overcome this. Again adjustments to the system itself are required. Equalisation is the final tuning stage. Generally, a gradual transition between adjacent bands should be aimed for, particularly in studio monitoring situations where the maximum difference between bands should only be 3dB or so. A warning bell should be ringing if you are using much more than this! This does not mean however that more drastic adjustments should not be used - this is very often necessary with sound systems operating in poor or severe acoustic environments, but the reason why such a particularly large fader excursion is being used at a given frequency should always be carefully considered.

Once satisfied with the basic system, performance equalisation can begin. If using a real time analyser ensure that the microphone is in a sensible position i.e within the coverage area of the system and not in an area where strong local acoustics effects might be expected such as within 1 metre of a rear or side wall or in a balcony opening.

A good idea is to rotate the measuring microphone in a wide arc or circle round the measuring position and to see if any strong interactions occur causing large deviations in response. If necessary, move to another position. Also ensure that the ambient noise level is at least 6dB (preferably 10dB) below the signal level you are using.

Having set up the desired house curve as smoothly as possible, move round and check the response throughout the listening area. Good equalisation requires time and patience. Do not forget that some interaction will occur between a particular filter and its adjacent bands. A better sound may be produced by adjusting several bands rather than by strong cutting just the centre one. Do not forget to pause to talk or play music through the system as you go, so that you keep in touch with what the resultant sound quality is like.

If the Real Time Analyser you are using is the Klark Teknik DN6000 you have a powerful averaging capability which means that averaging the response throughout the coverage area becomes very much easier. The response displayed by the analyser should also become smoother as local fluctuations are averaged out whilst persistent peaks and dips clearly stand out and show where adjustment is truly required.



DN6000

Connecting a stage or house microphone into the analyser can be a most instructive exercise - showing up any local reflection or acoustic resonance or loudspeaker sidelobes. Generally repositioning the microphone or adjusting individual microphone channel equalisation will be needed, rather than adjustment to the overall house curve. This technique is particularly useful when investigating acoustic feedback after the initial house curve has been set.

Inserting the Equaliser in the Signal Chain

The exact point of insertion of an equaliser into the signal chain will very much depend on the task in hand e.g. mixer channel / line input, group insert point, group output, auxiliary send or between another signal processing device and the mixer or power amplifier, etc. when using delayed out signals for example, i.e. where a digital delay line is being used to synchronise sound arrivals in order to maintain intelligibility or source directionality, the option may exist to insert the equaliser either before or after the delay line e.g. In a conference venue employing similar loudspeaker types throughout the system, but connected to different delay outputs, the equaliser can be inserted before the delay line. In a more complex system where several loudspeaker types are employed, or where the local acoustic environment differs within the same system e.g. theatre system with a central loudspeaker cluster and delayed side fills or underbalcony speakers, each delay channel will need its own separate equaliser in order to satisfactorily equalise out either the different loudspeaker responses or the effects of the different local acoustic environment.

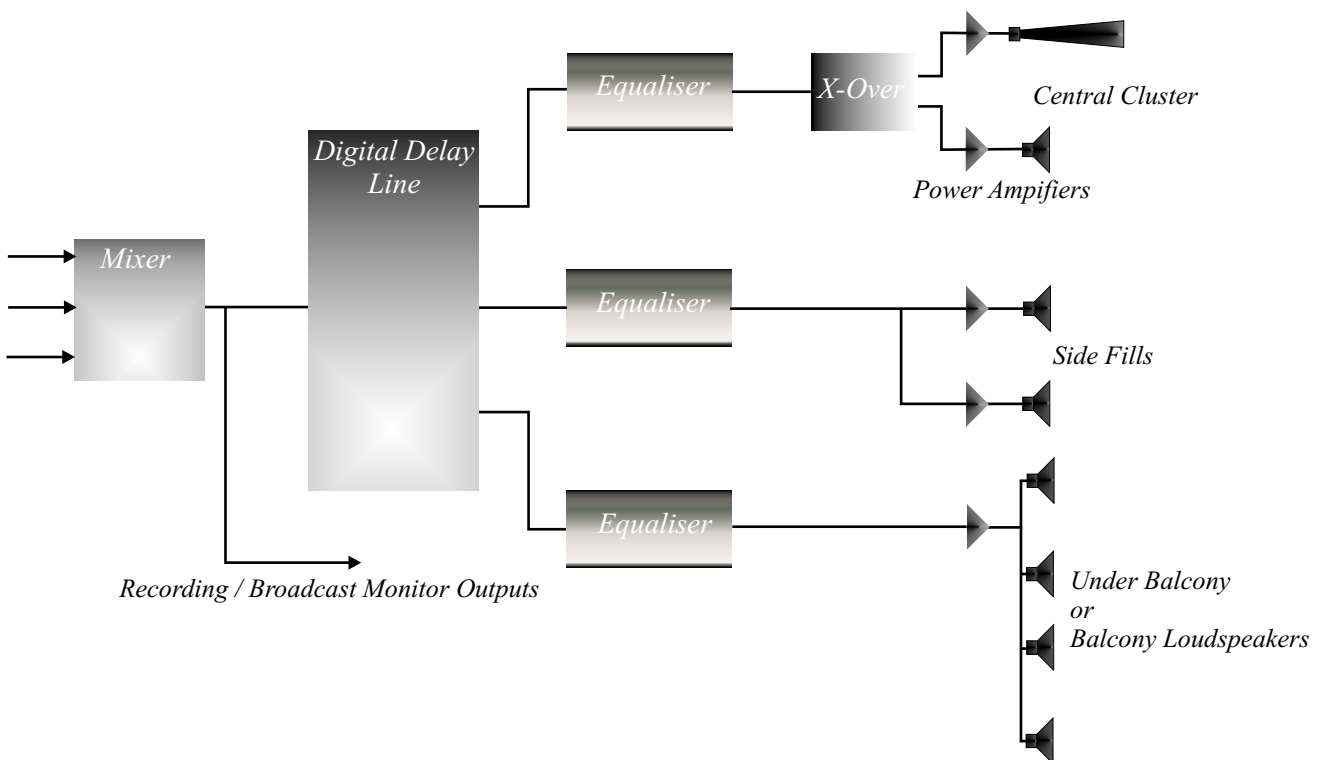

Typical Sound Theatre System

Equaliser Limitations

The equaliser is not the answer to poor sound system design - but instead it should be considered as a final tuning measure - such final tuning can often bring about quite remarkable improvements to the overall intelligibility and perceived sound quality of a system.

After an equaliser, a security cover is probably the most useful accessory a sound system could have. Equalisers, when used competently, can do wonders for your system - but when used badly.....

Important Note:

It is often useful to call your dealer or the factory explaining the nature of the problem with the unit. In many instances the problem can be solved without returning the unit to the factory. If the unit has to be returned to the factory, use original packing only. If you do not have one, we will provide replacement.

Factory authorised service facilities are located throughout the world. Call your dealer or the factory for the location of the service facility nearest you.

Klark Teknik Group.
Klark Teknik Building,
Walter Nash Road,
Kidderminster.
Worcs.
DY11 7HJ.
England.

Tel: +44 (0) 1562 741515

Fax: +44 (0) 1562 745371

KLARK TEKNIK GROUP FREQUENCY RANGE CHART

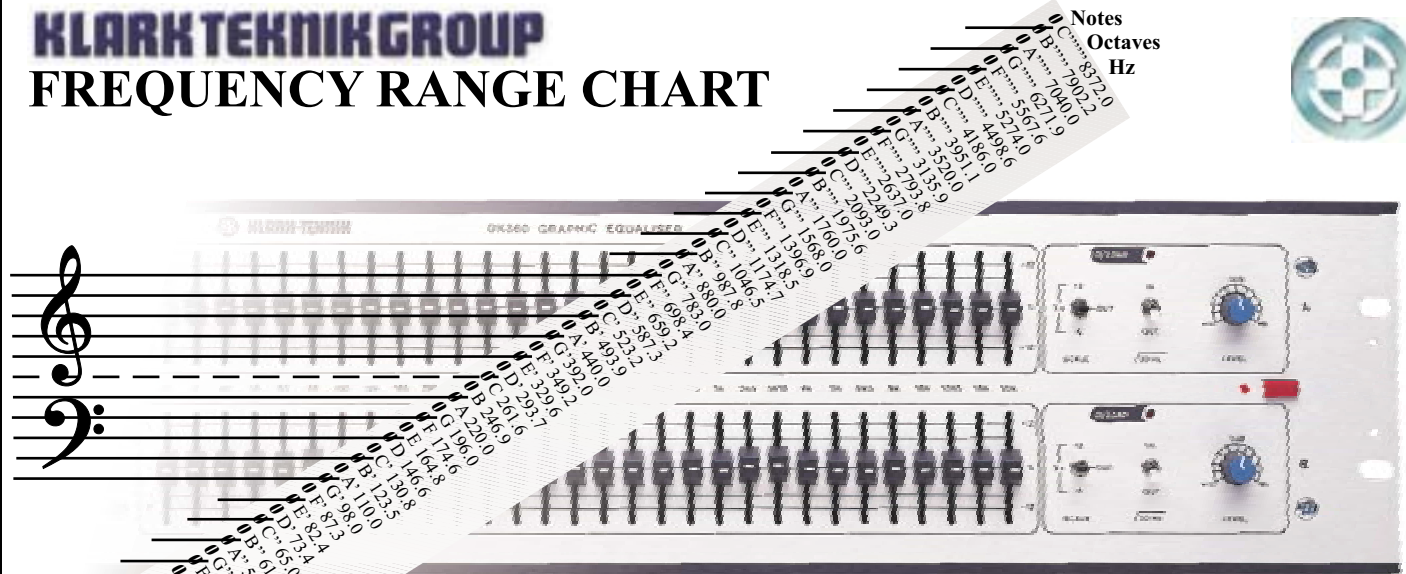

NOTES RELATED TO FREQUENCIES

This chart shows (above) the musical notes and octaves related to their actual frequencies. The details are cross references (below) to the frequency range of our Graphic Equalisers and the range capabilities of common musical instruments

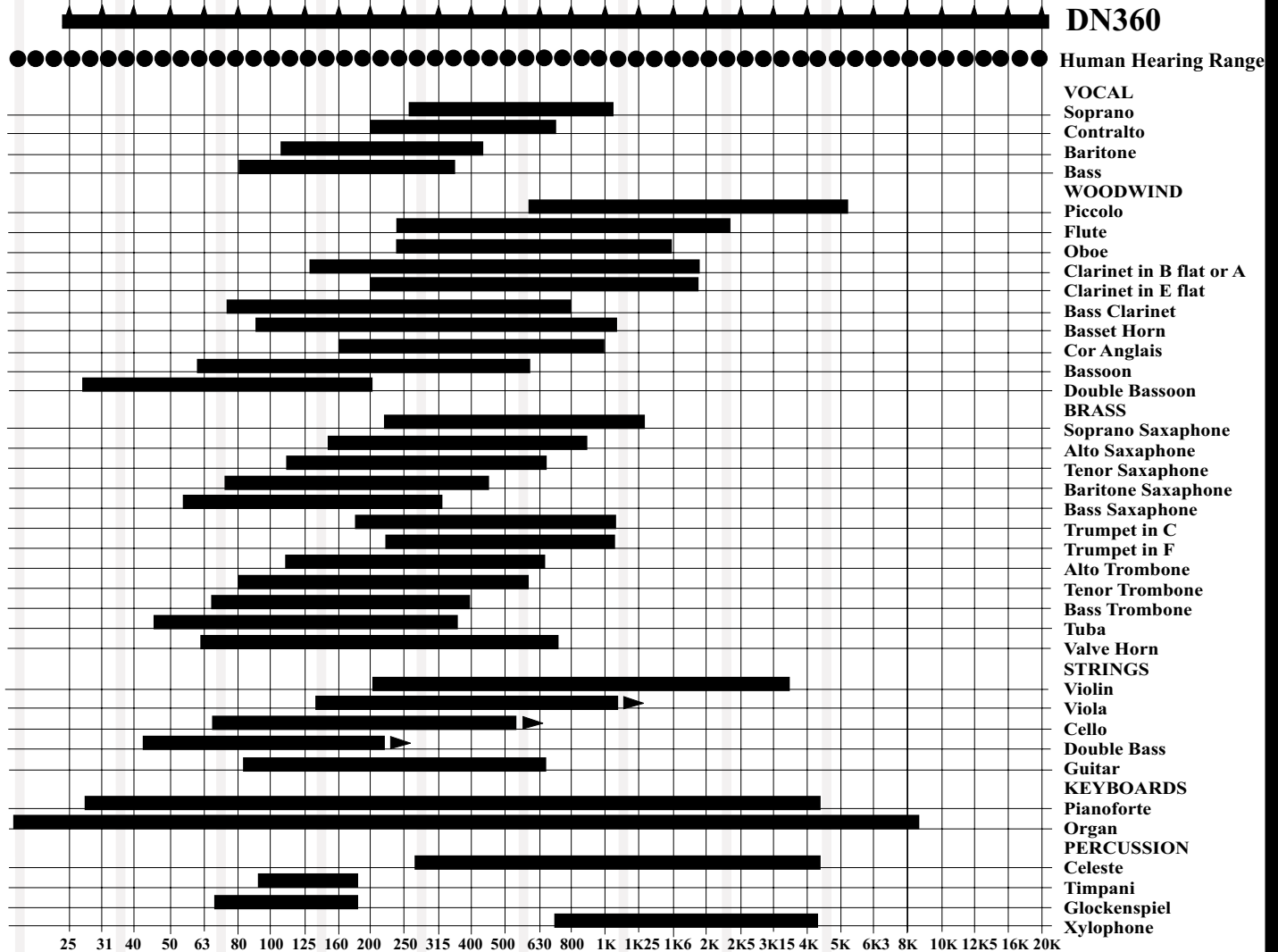
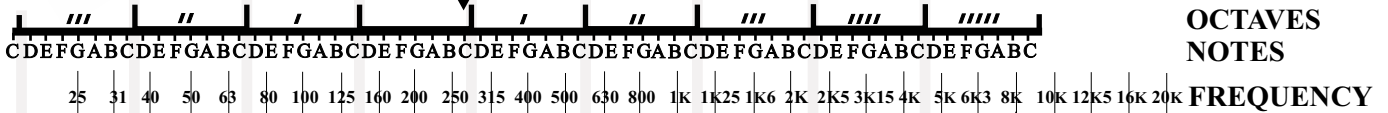

Copymaster Do Not Remove

Please photocopy when required

KLARK-TEKNIK DN 360 GRAPHIC EQUALISER

A

B

Fader Setting Record Chart: Equaliser No: Serial No: Location: Date:

KLARK-TEKNIK DN 360 GRAPHIC EQUALISER

A

B

Fader Setting Record Chart: Equaliser No: Serial No: Location: Date: